

380070
H.O.N.E.Y.

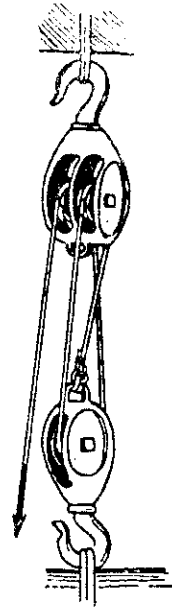

BUSHCRAFT

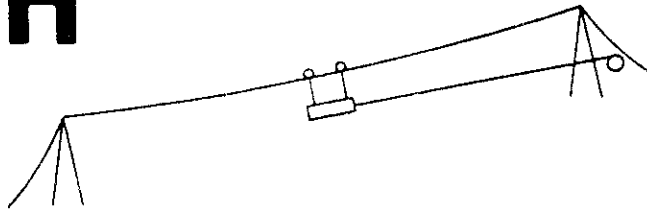

SCOUTING &

WOODLORE



NOTES

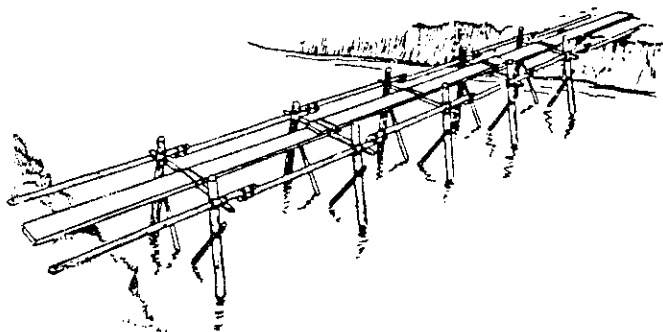

VOL I

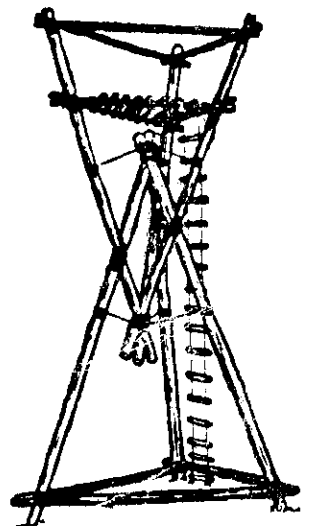

DR R W OELSLAGER

- FORWARD -

Bushcraft is the art of maintaining oneself and making one's way in sparsely settled, scrub covered or forested areas. This is done by using knowledge and various skills gained through study and experience with a minimum of tools or equipment. It teaches one to face nature on her own terms. It sharpens the senses and aids you to adapt, improvise and overcome difficulties. It builds and maintains your pride, confidence and self-determination and gives you the ability to lead, endure and succeed.

Scouting is the youth movement, started in Great Britain by General Lord Baden-Powell. This movement teaches boys, girls, men and women the skills and crafts of the out-of-doors. It teaches teamwork, cooperation, self-reliance and leadership.

Woodlore is having knowledge of the woods. It is knowing the names of the trees and flowers, the identification of wild edible plants, the building of shelters and the methods of making proper fires. It is learning and teaching the practices of anything relating to the woods including the building and construction of bridges, towers, rafts and camp gadgets. It is knowing about ropes and what to do with them.

The purpose of the information in this book is to help teach some of the basic fundamentals of the various skills that you may use in the bush. It will help you become acquainted with the various subjects that can give months of projects and programs, not only to yourself, but to many others.

Happy Trails,

A handwritten signature in cursive script, likely belonging to the author of the text.

CONTENTS

1. The Knife	1-14
2. The Axe	15-34
3. Saws	35-44
4. Tools and Simple Machines for the Woodsman	45-62
5. Rope, Cordage and Knots	63-92
6. Splices, Lashings, Anchorages and Tightening Arrangements	93-108
7. Rope Specialties	109-144
8. The Topographical Map	145-158
9. The Compass	159-172
10. Rafts and Floatation Devices	173-189
11. Fires, Fire Lays and Fireplaces	190-205
12. Estimations	206-223
13. Booby Traps and Codes	224-232
14. Demonstrations and Learning Experiences	233-244
15. Group Challenges	245-258
16. Hypothetical Problems	259-288

CHAPTER 1

THE KNIFE

HISTORY

The knife is probably the most useful of all common tools used by man. The knife was one of the first tools developed by the cave man. He shaped and ground thin pieces of flint and quartz to make knives for skinning animals and cutting meat.

The earliest metal knives were made of bronze. As the various other metals came into being, knife blades went through periods of copper, brass, iron and steel. During World War II, stainless steel came to be accepted as good alloy steel for knives. Chromium is the chief alloy used with iron, carbon, manganese and silicon in making stainless steel. The more common stainless steels usually contain about 8% nickel. Other elements may be added which will modify stainless steel for a specific job. Stainless-clad steel is commonly ordinary steel to which a thin layer of stainless steel has been bonded. The stainless steel process is a method of combining a special group of alloy steels which help resist corrosion and rust. In other words, it will stain "less." It is not stain "proof." Many different grades of stainless steels have been developed to afford different balances of strength, ductility, and resistance to corrosion and heat.

The pocket knife was developed as an aftermath of the swords, scabbards and sheath knives of earlier times. It is not definitely known when the first pocket knife was made, but it was probably in the 17th century. The jack knife, the grand-daddy of the folding knives, was probably first manufactured in the 1600's by a man called Jacques De Liege, which means Jack of Liege, a city in Belgium. This is perhaps where the knife got its name "Jack."

Folding knives became popular and part of that popularity was because of the pen knife. The folding pen knife also came into being in the 1600's in Sheffield, England. Back in the 17th century, writing was done with quill pens made from goose quills. These quills were carved into a nib at the tip of the quill for writing. The nibs frequently became clogged or mushy with ink, so a small folding knife was developed to pare the ends of the quills. As time went on, different types of folding knives came into being.

The knife also was one of man's first weapons. Throughout the Middle Ages and the Renaissance, knives in the form of daggers were the favorite small weapons of the soldiers. In pioneer days, American frontiersmen used

the Bowie knife both as a weapon and as a tool. Even during World War II, in which most weapons were complicated and scientific in nature, the Commando knife was used in hand-to-hand combat fighting. Later on, the Combat-Survival knife became the preference of many of the fighting men.

Throughout history, the knife has served man both as a tool and as a weapon. As a tool, the knife today is used in every walk of life. The artist uses a palette knife to help create works of art. The sculptor's blade is his most important tool when he is working with ebony and ivory. The physician's scalpel helps to save lives. The carpet layer, the cook, the electrician and the sportsman all have their favorite knife for a special purpose. Probably the most used knife of all is the common table knife which can be had in all sorts of sizes, shapes and patterns. Figure 1 shows some of the most common knives.

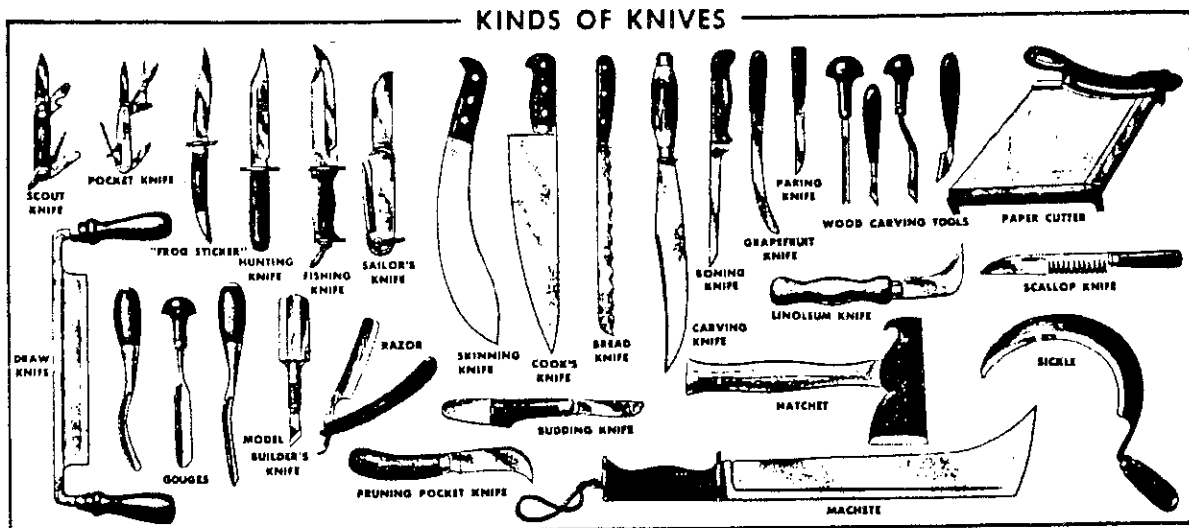

Figure 1 Most Common Types of Knives

CLASSIFICATION OF KNIVES

As seen in Figure 1, knives come in such a large assortment of sizes, patterns and styles that it becomes a difficult endeavor to put them into some type of order. However, the bulk of the knives would fall into the following five classifications:

- A. Household Knives
 - Table knife
 - Skinning knife
 - Boning knife
 - Paring knife
 - Cook's knife
 - Bread knife
 - Grapefruit knife
 - Carving knife
 - Etc.

B. Tradesmen's Knives

- Woodworker's knife
- Pruning knife
- Electrician's knife
- Sailor's knife
- Fruit knife
- Cable knife
- Linoleum knife
- Yachtman's knife
- Etc.

C. Pocket Knives

- Jack knife
- Pen knife
- Clasp (Lockblade) knife
- Utility knife
- All-Purpose knife
- Specialty Pocket knives
 - Stock knife
 - Bird knife
 - Rope knife
 - Whittler's knife
 - Fisherman's knife
 - Trick knife
 - Field Dressing knife
 - Commemorative knife
 - Advertising knife
 - Etc.

D. Belt or Sheath Knives

- All-Purpose Sheath knife
- Skinning knife
- Fillet knife
- Military Commando knife
- Survival knife
- Large Belt Variety of Folding Sheath knife

E. Miscellaneous Knives

- Scuba knife
- Boot knife
- Ceremonial & Exotic knives
- Push Dagger
- Machete
- Etc.

MAKING POCKET KNIVES

The pocket knife is a knife with folding blades so it can be carried in the pocket, such as the jack knife, pen knife and clasp knife. Pocket knives are usually made of steel, which is hammered

into shape or forged by hand. The blades are made from strips of steel which come in the right width and thickness from the steel mills. These strips are then cut into working lengths. Then the ends are heated until they glow a bright red. The blade is shaped roughly with a hammer by a process called mooding. Then it is cut to exactly the right length, leaving enough for a section called the tang to fit into the handle. After the tang has been shaped, the blade is reheated and hammered. A groove, called the nail mark, is cut into the blade, so that the thumbnail can be used to open the knife. This process is called smithing.

HARDENING AND TEMPERING

The blade is hardened by bringing it to a red heat and then dipping it suddenly into cold water or other solution. The tang is left soft so it can be filed easily and drilled and fitted to the handle. Now the hardened blade is tempered.

Tempering is a process of hardening metals, especially steel. Steel can be made very hard, strong and tough by tempering. First, the steel is heated to a high temperature. Next, it is cooled rapidly by plunging it into water, oil or other liquid. Finally, the steel is heated again to a temperature lower than that used before quenching it, and it is again allowed to cool slowly. Tempering changes the internal structure of the steel. Different uses of steel require different properties, such as different degrees of hardness, strength and toughness. To obtain these desired properties in different degrees, the structure of the steel is changed by tempering at various temperatures.

The tempered blade is then sent to the grinder, who places the tang in a holder, which he grasps as he holds the blade against a grindstone to sharpen it. A final finishing is given the blade after it is fitted to the handle. Other parts of the knife are made by the material maker, and then the cutler puts the various parts of the knife together, along with drilling, filing and polishing of the handle.

THE STEEL OF THE KNIFE

The most important thing in all knives is the steel. Steel, of course, is a commercial iron that contains carbon in any amount up to about 1.7% as an essential alloying constituent. It is malleable under certain suitable conditions, and is distinguished by its malleability and lower carbon content. Steel is often classified as:

Soft Steel, having a carbon content of less than .25%

Medium Steel, having a carbon content of approximately .25 to .60%

Hard Steel, having a carbon content of over .60%

Professional knife makers add many other elements to the steel, such as chromium, molybdenum, silicon, tungsten, manganese and sulphur, along

with other trace elements in an effort to make the perfect knife which will not rust, break, or ever have to be sharpened. Chromium improves hardness and prevents rust; nickel increases toughness and resistance to heat and acids; manganese increases strength and resistance to wear; molybdenum increases strength and resistance to heat; tungsten retains hardness at high temperatures and vanadium increases resiliency.

ROCKWELL HARDNESS

Professional knifemakers have set up the "Rockwell Scale" that determines the relative hardness of steel, which involves forcing a diamond point into a finished blade of steel. The depth of the indent is measured, and this is what gives the scale of hardness.

The Rockwell Scale is noted as "RC" or sometimes as "RH" (Rockwell Hardness). The scale for good knives usually runs from about 56 to 64. If a knife blade has an RC of 68 on the Rockwell Scale, it may not hold an edge as well as a blade with an RC of 60. Hardness and edge holding are not precisely related because of the many different factors and elements entering into the making of a good knife.

Most knifemakers work with steel having a carbon content of 1% or what they call a 440-C. However, if more tungsten, cobalt, etc. are added, steel leaves the range of tool steel and enters the realm of high speed steel, which will have different properties. This will make steel for knives too brittle and it cannot be sharpened well. With the many variables in steel, the alloy additives and tempering, knife making becomes a very complex art.

TYPES OF POCKET KNIVES

Pocket knives come with an array of blade patterns and points for various purposes. Some of the most popular blade points are shown in Figure 2. The most common points include the following:

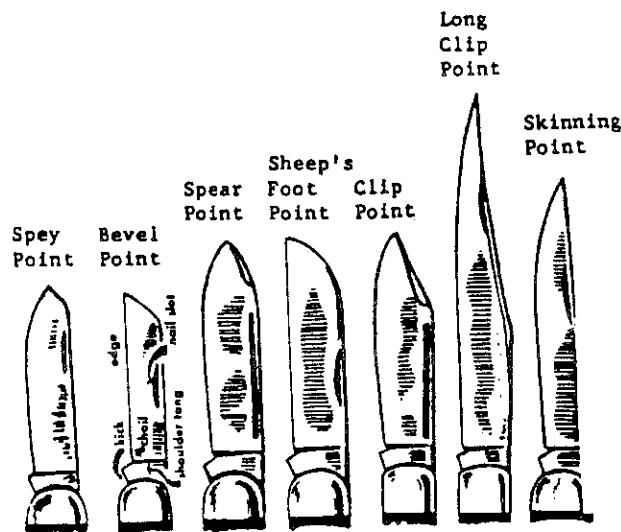

Figure 2 Basic Blade Points

1. Spey (or Spay) point for getting into corners and general cutting.
2. Bevel or Coping point used for cutting curves or scoring cuts.
3. Spear point used for general cutting and countersinking.
4. Sheep's Foot point used for heavier cutting at the end of the blade.
5. Clip point used for heavier cutting jobs.
6. Long clip point used for long slicing and incisions.
7. Skinning point used chiefly for skinning and cutting up animals.

Specialty blades are numerous and a part of many pocket knives. These include such blades as scaling blades, saw blades, razor blades, file blades, cuticle blades, pruning blades, punch blades and a host of other blades. Innumerable tools may be added such as awl blades, screw drivers, bottle and can openers, gutting tools and almost anything else imaginable.

Handmade knives are crafted to the customer's design. They are made by knifemakers who are fine craftsmen who take great pride in their work and fine cutlery. However, manufacturers like Gerber, Buck, and Cutlery turn out excellent knives - both pocket and sheath.

Probably most good campers prefer a sturdy multi-blade pocket knife with carbon steel blades, rather than just stainless steel blades. In any event, when purchasing a knife buy the best you can afford and stay away from the cheap all-purpose knives with fancy breakable handles. A 4 to 5 inch blade should be maximum length. Anything longer is too long for the pocket. Some of the most common pocket knives are shown in Figure 3 and are listed here with their descriptions:

1. Jack knife is a large strong pocket knife with blade openings usually only on one side. There are usually 1 to 3 blades - a large blade for heavy work, a thinner sharp blade for removing splinters and delicate cutting, and sometimes a third blade in the form of an awl or sharp pointed reamer. This knife is ideal for every day work.
2. Pen knife is a smaller, more delicate knife with blade openings on each side. Originally it was used for making and mending quills for pens. Now it is used for smaller cutting jobs from strings to hanging threads. It is excellent for the businessman to clean fingernails, open boxes, and use on smaller jobs. It is slim and trim.
3. Clasp knife (Lockback) has the cutting power of a fixed blade with the convenience of a folding knife. Blade locks open and it is used for everything from cleaning and dressing deer to cutting rope and wood. They are available in every size to fit every need.
4. Utility knife is for work, fun, and camping. They usually have a rugged large blade with can opener, bottle opener, reamer, and a screw driver. If you buy one, get one with good steel and be sure the can opener (if it will be used) is on the proper side of the knife. If you are right-handed, the can opener should

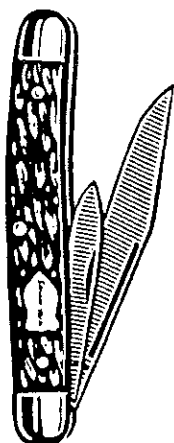

1. Jack Knife

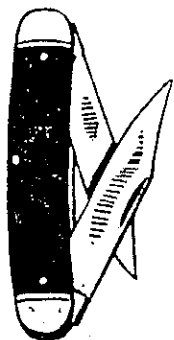

2. Pen Knife

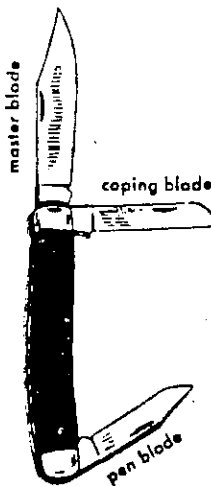

6 b. Whittler's Knife

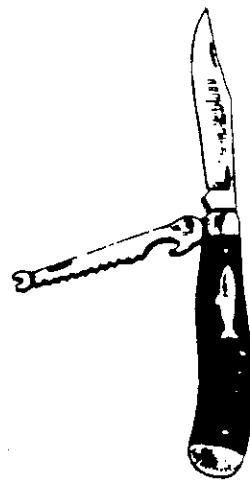

6 c. Fisherman's Knife



3. Lockblade or Clasp Knife

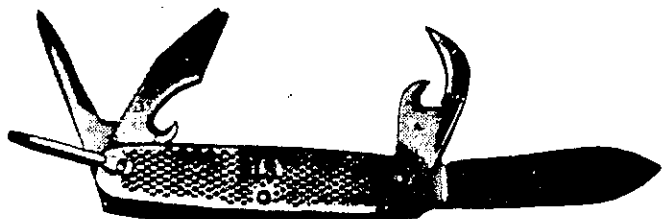

4. Utility Knife

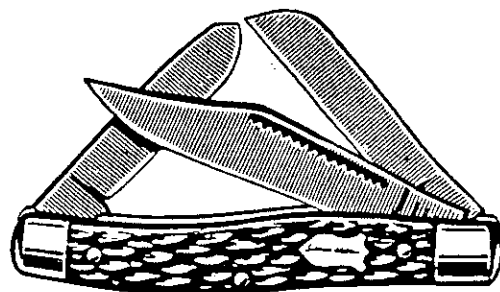

6 d. Stock Knife

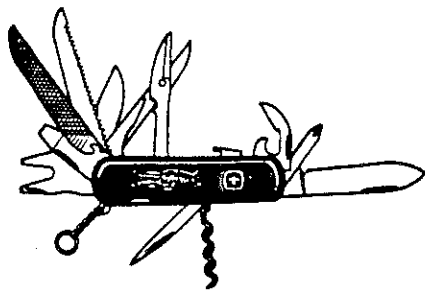

5. All-Purpose Knife

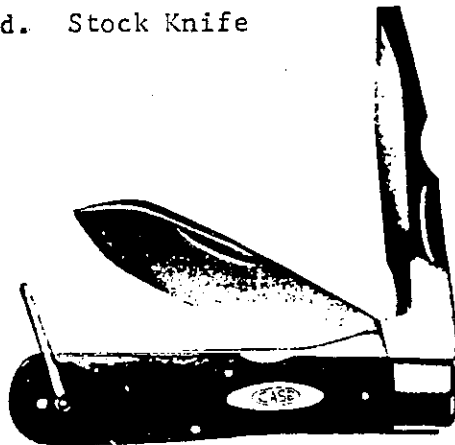

6 e. Electrician's Knife

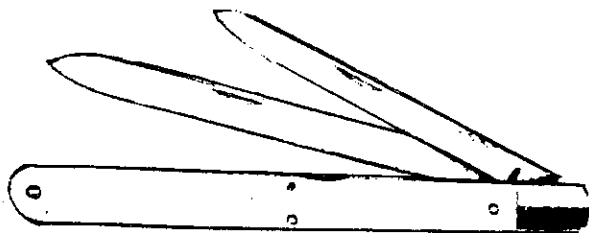

6 a. Fruit or Melon Knife

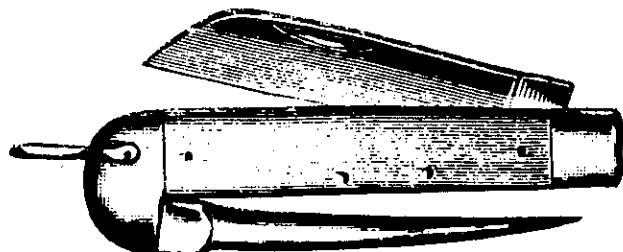

6 f. Rope or Yachtman's Knife

Figure 3 Types of Pocket Knives

be on the left side of the knife as you hold the knife to open a can. If you are left-handed, it should be on the opposite side.

5. All-Purpose knife has a complete tool kit or a tool for any purpose. If you buy one, again get it with good steel. One of the best is the Victorinox Swiss Officer's Knife. There are about ten different sizes depending upon how many tools you want available. Beware of the cheaper all-purpose knives.
6. Specialty Pocket knives are those knives that are made for special purposes. There seems to be a special knife for every hobbyist and tradesman. Some of the most popular Specialty Pocket knives are as follows:
 - a. Fruit (Melon) knife is a long bladed knife used for fruits. It has a long slim blade suitable for peeling, coring and long slicing.
 - b. Whittler's knife is designed for whittling with a special blade for carving. The small coping blade is for scoring cuts and sharp corners.
 - c. Fish (Fisherman's) knife has a long clip pointed blade for long slicing plus a scaling tool and a hook disgorger.
 - d. Stock knife is a heavy duty knife that usually has three blades. The clip blade is used for heavy cutting; a Sheep's Foot blade, and the Spey blade. The knife fits easily into the pocket or tool box.
 - e. Electrician's knife is a multi-purpose knife that actually is a useful tool designed for the electrician, carpenter, mechanic or the do-it-yourselfer. It includes a large spear blade and a locking screw driver-wire stripper blade. Sometimes a third Sheep's Foot blade is added. A handy shackle is usually a part of the knife so it can be attached to the belt easily.
 - f. Yachtsman's knife consists of a marline spike, a shackle tool, a heavy cutting blade and a screw driver. This is an excellent knife for the sailor or for one who does a lot of rope work. It is also called a Rope Knife.
 - g. Bird knife is a special knife for cleaning large birds and ducks. It has a gutting tool attachment for cleaning out the entrails. (Not shown.)
 - h. Cable knife is a stout knife for use with wire and cable. It has a heavy blade with an attachment for stripping wires. (Not shown.)

- i. Trailing Point (Field Dressing) knife is another specialty knife for field dressing of animals. It is a clasp type knife with saw blade for cutting through bone and cartilage, a field dressing blade with a blunt end so as not to cut into the animals entrails or meat when removing the hide. It also has a good skinning blade for dressing and cutting up meat. (Not shown.)
- j. Commemorative or Decorative knives include those knives which are made for commemorating certain events, advertising certain products, and knives which have certain decorative effects. Many of these knives become collector's items. (Not shown.)
- k. Pruning knife has a curved pruning blade which is ideal for the gardener or greenhouse worker. (Not shown.)
- l. Pipe Smoker's knife features a tamping head, a spike for cleaning out the stem and a flat narrow blade for bowl cleaning. (Not shown.)

NOMENCLATURE OF THE POCKET KNIFE

In recent years, much of the nomenclature on both pocket and belt knives has been carelessly used and expanded so that you can come up with a lot of terminology, but most knives still have two main parts, the handle and the blade. The blade's cutting or sharpened portion is called the edge. The top of the blade is called the back or spine. If the top of the blade has a curve, no matter how slight, it is known as the sweep. The bolster supports the hinged mechanism of the knife blade. The remainder of the blade nomenclature of the pocket knife is shown in Figure 4.

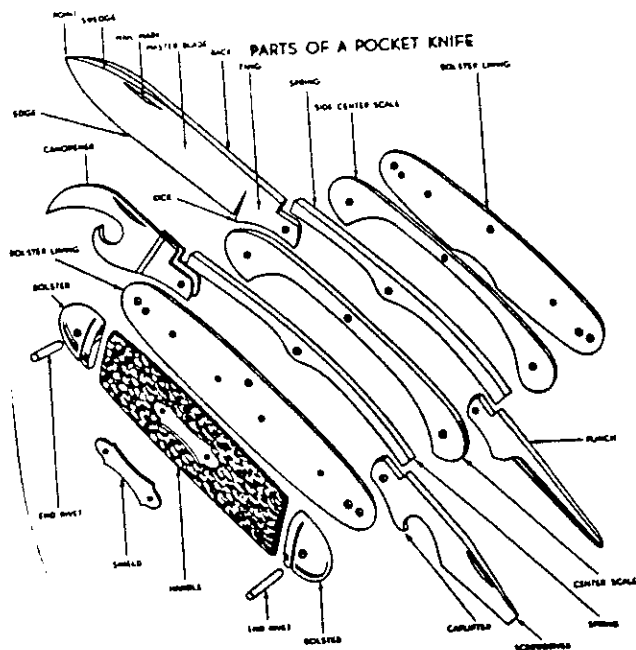

Figure 4 Nomenclature of the Pocket Knife

SHEATH KNIVES

Basically, sheath knives are made similar to pocket knives. With the constant advances in manufacturing, all knives can be turned out quickly nowadays. Only the skilled knife makers take real pride in an individual knife.

Sheath knives definitely have a place for the camper for hard, rough cutting, and some people prefer to skin animals with a larger knife. Most people enjoy owning a sheath knife, and if used properly it can be a very useful tool.

Figure 5 shows some of the most popular forms of belt knives. Some of them are listed here:

1. All-Purpose sheath knife
2. Skinning knife
3. Fillet knife
4. Military Commando knife
5. Survival knife
6. Large Belt variety of folding knife



1. All-Purpose Sheath Knife

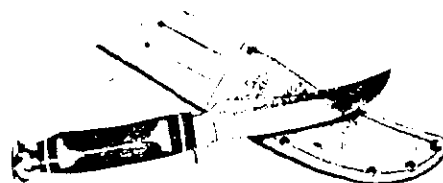

2. Skinning Knife



3. Fillet Knife



4. Military Commando Knife



5. Survival Knife



6. Large Belt Variety of Folding Knife

Figure 5 Basic Types of Sheath Knives

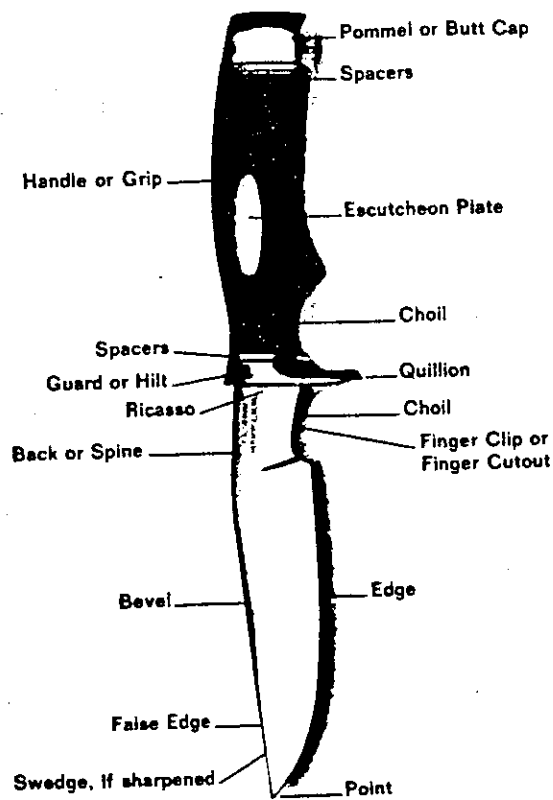

Figure 6 Basic Nomenclature of the Sheath Knife

Sheath knives, like pocket knives, consist of a handle and a blade. Usually the handle of the knife is secured around the tang, which is an extension of the blade into the handle of the knife. A tang may be a full tang which is exposed and follows the general width of the blade, or it may be a narrow tang when it is completely encased by the handle. The butt cap or pommel is the very end of the handle. Some knives are made with spacers, some have an escutcheon plate (name plate) and some handles may have a choil, which is a finger cutout. At the blade end of the handle is usually a guard or hilt, and the small crossbars extending from each side of the hilt are the quillions, which may be double or single. The ricasso is that portion of the blade right in front of the guard. The various planes and angles ground into the blade are bevels which add beauty to the entire blade. The top of the blade is the spine of the knife. That part of the blade running from the tip of the spine is called the false edge, and if sharpened is called the swedge, and of course, if the entire spine is edged it is called a double edged knife. Many hunting knives have a groove along the side of the blade called the fuller or blood groove. This also aids in strengthening the blade. For the full nomenclature of the sheath knife see Figure 6. Occasionally on a sheath knife you will

see a set of teeth on the spine. Originally these were put on to cut through metal in aircraft. They are called raker teeth. They are used for hacking, chopping and other heavy use when you don't want to damage the blade.

The variety of sheath knives is endless with the myraids of designs and decorations. Many of these knives are of little value to the average person. However, there are collectors who preserve all types of knives by careful and sparing use. Some of these specialty knives include the Scuba Diving knife, Boot knife, Push Dagger, Throwing knives and Camping knives.

THE MACHETE AND DRAWKNIFE

Before leaving the subject of knives, there are two other knives worth mentioning that make excellent knives for various things in bushcraft and woodlore. They are the machete and the drawknife. See Figure 7.

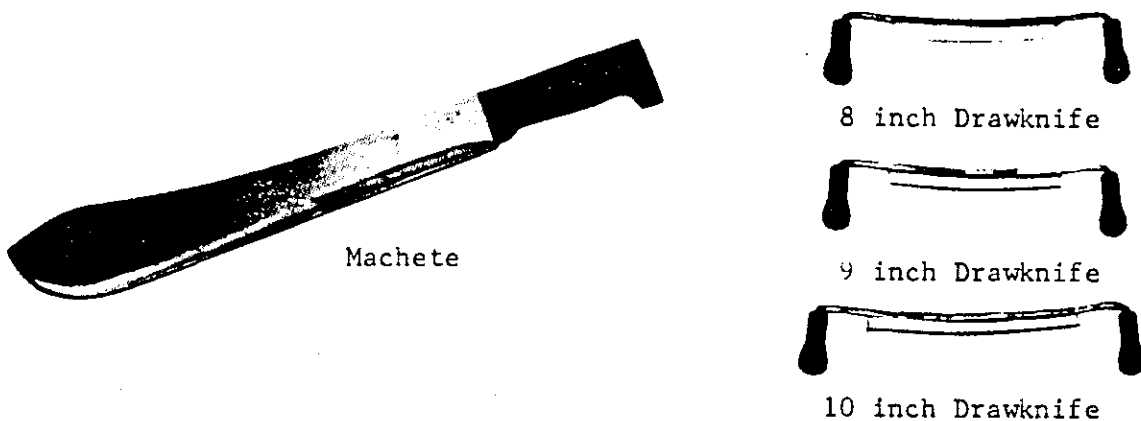

Figure 7 Machete and Drawknife

The machete is a large heavier knife and it has a long blade. It is used especially in Latin and South America and in the West Indies for cutting sugar cane and clearing paths. The blade is heaviest at the pointed end. It is an all-purpose working and survival tool and is an excellent implement for cutting smaller branches, tall grass, vines and weeds. It is good for hacking away almost any kind of underbrush. Be sure you have plenty of room to swing the machete when using it. Branches and brush may cause the strokes to be deflected and injuries could result. So, even though it is a good tool, use it with care.

The drawknife or drawshave is one of the older tools which is becoming somewhat obsolete. However, it is an excellent tool for woodcraft. The drawknife is a woodworker's tool having a blade with a handle at each end. It is used for shaving wood surfaces, debarking and hewing. Even though this tool is becoming scarce, it would be worth your while to have one if you intend to do a lot of bushcraft pioneering. It is described further in Chapter 4.

The knife is probably the camper's best friend. If you get a good knife and treat it right, it will give you years of good service.

CARE OF KNIVES

As with the pocket knife, a sheath knife should be a "choice" piece of equipment. The blade should be of good steel, it should have good balance and should be a comfortable length. It should have a tough handle and all parts should be tight. The sheath should be sturdy and well made so it offers good protection for the knife as well as the body of the person carrying it.

All knives should be kept clean and sharp. Moving parts should be oiled occasionally, especially on the pocket knife. When not in use, knives should be folded or sheathed and stored properly.

Knives should not be sharpened on a grindstone, emery wheel or with a file. Instead, a knife should be honed. A hone is an abrasive stone akin to the whetstone, which is a fine grit stone for whetting or sharpening edged cutting tools.

A steel is used for setting the edge on a newly sharpened knife. The steel does not actually sharpen the knife but it realigns the microscopic teeth forming the cutting edge and then revives the sharpness. As in the case of a butcher cutting up meat, he takes his sharp knife to the steel quite often, not to sharpen the knife, but instead to keep it sharp.

A strop is a piece of special leather or a specially treated cloth used for putting a fine edge on razors and other ultra sharp cutting instruments.

SHARPENING AND HONING

There are many whetstones on the market. Many of these are quarried in Arkansas and most of them are either soft or hard. These stones are treated with petroleum distillates. One of the best stones is the Washita Soft Arkansas Oilstone by A. G. Russell. There is also a Hard Arkansas Stone which may be used secondarily to the soft stone for a finer edge. If a razor-sharp edge is desired you can use an Arkansas Surgical Black Stone.

Cutting edges are restored by the use of abrasives cutting away the steel until a proper edge is achieved. When using a whetstone, a generous amount of honing oil is needed on the stone. This brings out the optimum abrasion from a stone because it keeps the stone's pores open. Never use lubricating oil on your stone as it will reduce the stone's abrasive character. The only way that lubricating oil could be used is by mixing it with kerosene. Use a mixture of one half oil and one half kerosene.

One good method of sharpening knives is to start off with a clean knife. Use soap and water on the blade if necessary and then wipe it off. If possible, the stone should be an inch longer than the blade you are sharpening. Use a liberal amount of honing oil on the stone. Too much oil is better than too little. Maintain the bevel of the cutting edge. A knife blade usually has an edge with a 20 to 30 degree angle. See Figure 8-A. If the knife is dull, start with the soft Arkansas stone. Place the blade across one end of the stone and raise the back of the blade until the cutting edge touches the stone. See Figure 8-B. Then using heavy pressure, as if cutting a thin slice of the stone, draw the cutting edge across the stone from heel to point. Reverse the blade and repeat. Alternate this procedure until the desired edge is obtained. If a finer edge is desired, repeat the above process with a hard stone. If you wish, you can finish with a few alternate swipes on a steel. Avoid too much honing as it will weaken the blade's edge by making it too thin and more susceptible to nicking. When a knife blade can neatly slice a piece of newspaper with the entire length of the blade without catches, the blade should be relatively sharp. Old timers have said that if a knife will slice bacon well, it is sharp.

A whetstone is a stone for whetting (sharpening) edge tools. They should be kept in a retaining block and covered when not in use so that dust and dirt does not impair the cutting action. Sharpening stones may be of natural or man-made material. Some of the best crystalline quartz stones, as mentioned

before, come from the Ozark Mountains in Arkansas. Man-made stones are usually aluminum oxide or silicon carbide. Silicon carbide stones include tradenames such as "Crystolon" and "Carborundum." They are a fast cutting hard abrasive for general cutting where moderate tolerances are required and speed of operation is important. Aluminum oxide (India stones) are for sharpening high quality steel tools. This abrasive will produce a smooth exceptionally keen cutting edge. It retains its shape well. These stones may be used dry, with oil or with water. Follow directions on the specific package. Oilstones are whetstones that require the use of oil. A slip stone is a pre-shaped stone that conforms to the edge of the tool being sharpened. It is usually rubbed along the edge to be sharpened. Perhaps the best man-made sharpening stone is the diamond sharpening stone which has real diamond chips embedded in nickel plated perforated steel on a plastic base. This stone is used and cleaned up with water. It comes coarse or fine. Boron carbide abrasive is next to diamond on the Mohr hardness scale. It will cut almost any material except diamond. It may be used on ceramics, glass, stone and carbon blades.

Keep you knife sharp. Use an oilstone frequently. Remember to keep the blade at an angle of 20 - 30 degrees to the stone when sharpening.

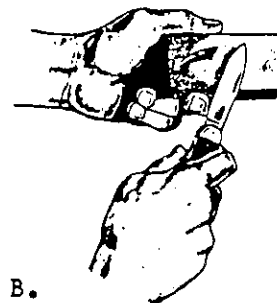
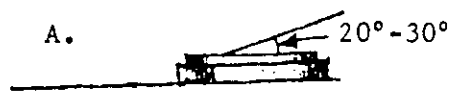

B.
SHARPEN KNIFE BLADE AGAINST THE EDGE, AS IF CUTTING INTO SHARPENING STONE. KEEP BACK OF BLADE 1/4" ABOVE STONE. TURN BLADE AFTER EACH STROKE.

Figure 8 Sharpening and Honing

CHAPTER 2

THE AXE

HISTORY

Axes were in existence thousands of years before Christ. The fact is, Stone Age people acquired a simple type of axe and haft about 30,000 B.C. Copper-bladed axes appeared in Egypt about 4000 B.C. Copper was followed by brass. Blades were fastened to hasps by a variety of means; they were lashed into a wooden sleeve, they were bound into a split of wood, or they were inserted into a bone socket.

The Bronze Age followed around 1800 B.C. During this time bronze, rather than copper or brass, became the choice material for implements, weapons and ornaments. This age was followed by the Age of Iron and Steel.

The development of the iron-bladed felling axe in the Middle Ages made possible the vast forest clearance of Northwest Europe and the development of agriculture.

The axe played a similar role in land clearance in North America. The axe helped subdue the American wilderness in the hands of early woodsmen. It built the house, made the furniture, supplied the fuel, protected the family and was used for money in bartering with the Indians. As steel went into the head, the axe became one of America's most popular tools. An experienced woodsman once said, "With an axe you can defend yourself, use it as a tool or weapon, build a shelter, cut materials for fishing, and with a suitable rock you can use the head for making spark and fire. With an axe you can leave good trail signs, use it for digging, and you can make tinder, kindling and fuel. You can make traps, triggers and deadfalls."

The woodsman's axe felled the trees and the broadaxe, with its single-bevel "chisel edge", squared the felled trees into beams, rafters and other building material, and the communities took shape.

TYPES OF AXES

In pioneer days, axes were made locally by blacksmiths, each according to his own ideas, and consequently, a tradition has developed in each locality favoring the style of axe started and used in the early years by the smiths in that vicinity. Thus the pattern for axes has become regional, and as a result, there are a maze of shapes and styles. Some of the most popular styles, which are still used today, are shown in Figure 9.

SINGLE BITS



New England
or
Connecticut



Yankee
or
Dayton



Michigan



Hudson
Bay

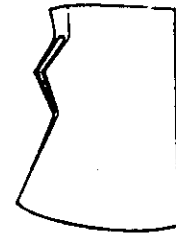

Jersey
or
Rockaway

DOUBLE BITS



Michigan
or
Crown



Pennsylvania
or
Western



Reversible



Wedge

Swamping

Figure 9 Types of Axes

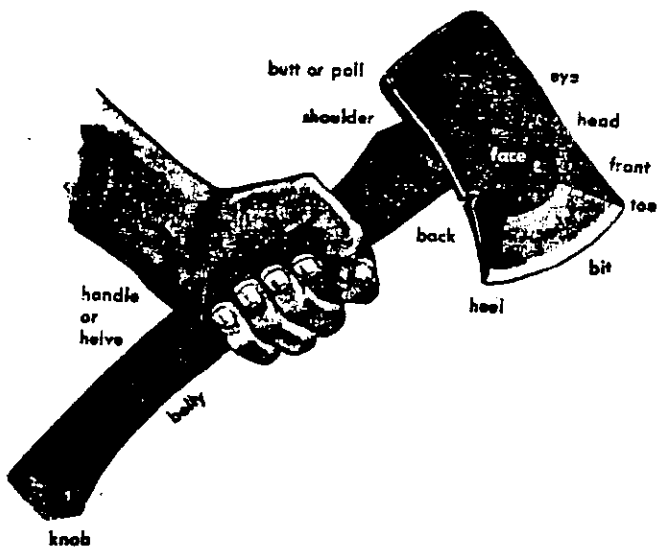

Figure 10 Parts of an Axe

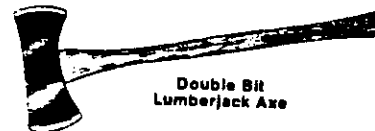

Figure 11 Single and Double Bit Axes

The axe has a series of parts with which we should become familiar. The parts of the axe are shown in Figure 10. Axes are single bit or double bit, as shown in Figure 11.

THE SINGLE BIT POLL AXE

The head of the single bit axe has the cutting edge and the poll. The poll is the extension of the axe head opposite the cutting edge. It is not for striking or to be used as a sledge. It is primarily to provide balance and greater momentum to the swing. The heads will come in various styles and weights, and the helves will come in various lengths. There are no set rules, but most poll axes will fall into one of five categories:

A. The Light Weight Axe is actually a miniature axe of extreme lightness. This makes a good survival tool for a survival kit, although there are people who want just a small axe for small jobs. In some cases, it can be very practical as a tool for bushcraft jobs. The whole axe would probably weigh up to around a pound. See Figure 12.

B. The Middle Weight Axe such as the hand axe or pack axe has approximately a $1\frac{1}{2}$ to a 2 pound head and a 13 to 15 inch handle. This makes an excellent axe for light camping and can be carried on a belt or in a pack when properly sheathed. See Figure 13.

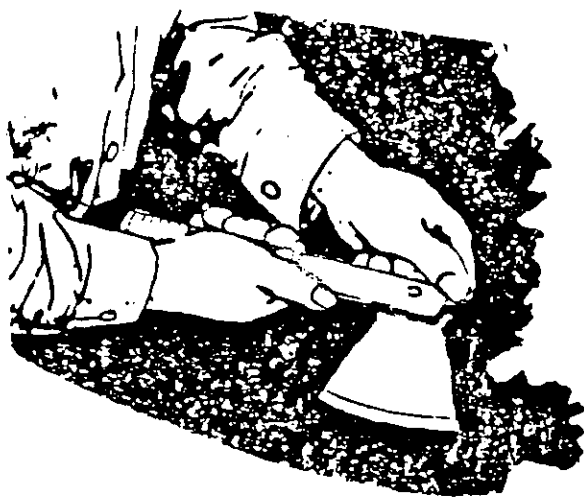
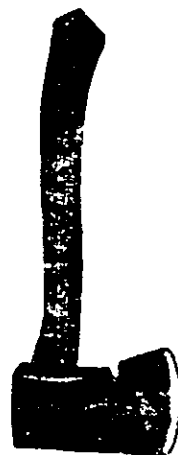

Figure 12 The Light Weight One Pound Axe



HAND AX OR
PACK AX
1½ POUND
HEAD
13¼" HANDLE

Figure 13 The Middle Weight Axe

C. The Woodland Camping Axe is a $\frac{3}{4}$ sized axe. It has a 2 or 3 pound head and an 18 to 28 inch handle. This is the best size axe for youngsters, and it is a good all-around axe for adults who are on canoe trips or doing average camping in the woods. See Figure 14.

D. The Felling Axe or Logger's Axe usually has a $3\frac{1}{2}$ to 6 pound head with a 30 to 36 inch handle. This type of an axe is needed when you intend

to take out trees and do other heavy chopping. This is an axe for the experienced. See Figure 15.

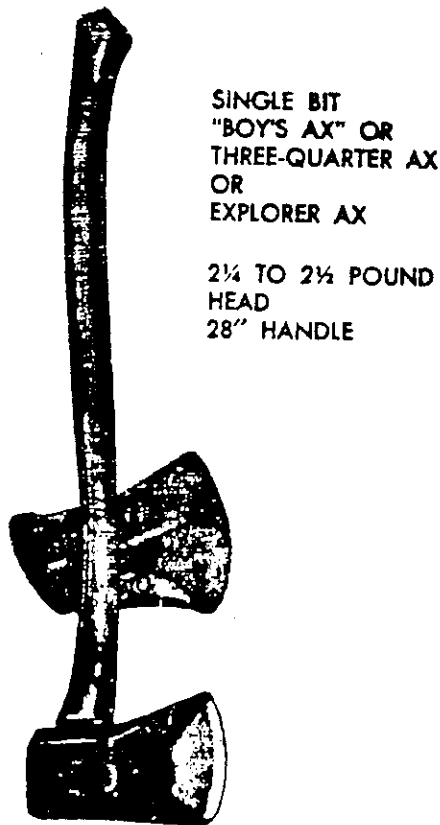

Figure 14 The Woodland
Camping Axe

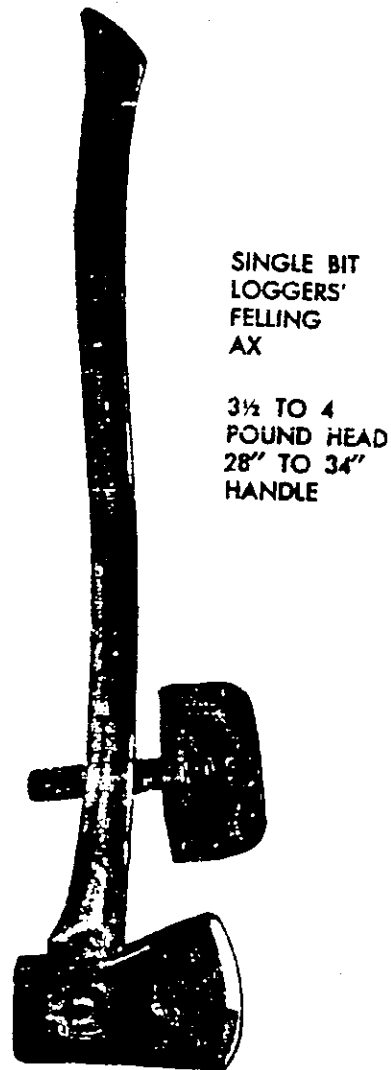

Figure 15 The Felling or
Logger's Axe

E. Miscellaneous Single Bit Axes are axes or "type axes" which do not fall into the above four groups. These would include such axes as (1) the broadaxe, (2) the adz, (3) the wood chopping maul, (4) the log splitting maul, (5) the hatchet and (6) the half-hatchet.

1. Broadaxe Over the years there have been many kinds of camping and felling axes, both double bit and single bit. The early felling axes filled the needs of the pioneers, and about that time the broadaxe was introduced. Although a few broadaxes were sharpened on both sides, the majority of them were chisel-edged

for squaring and hewing. It was excellent for hewing round logs into square beams. A man, skilled with a broadaxe, could transform a round log into a square beam in just a short time. As a rule, the adz would make surfaces smoother but usually took a little more time. The broadaxe is seen in Figure 16 along with the adz.

2. The Adz (Figure 16) is shaped like a hoe but has the cutting edge of an axe. This cutting tool differs from an axe, having an arching blade set at right angles to the handles, much like a grub hoe. The adz consists of a hardened steel head with a curved blade at one end $3\frac{1}{2}$ to $4\frac{1}{2}$ inches wide and usually a curved wooden handle to give balance and the proper angle for cutting. It is used for debarking, cutting, shaping and smoothing lumber or logs when a large amount of wood is to be removed. To use the adz, the timber to be worked should be straddled. The adz is then swung downward and towards the body, using short chopping strokes. The adz, like the drawknife, is becoming somewhat obsolete, but for the bushman who loves to do rustic building in the woods without all of the modern conveniences, the adz is a welcomed addition to his pioneering tools.

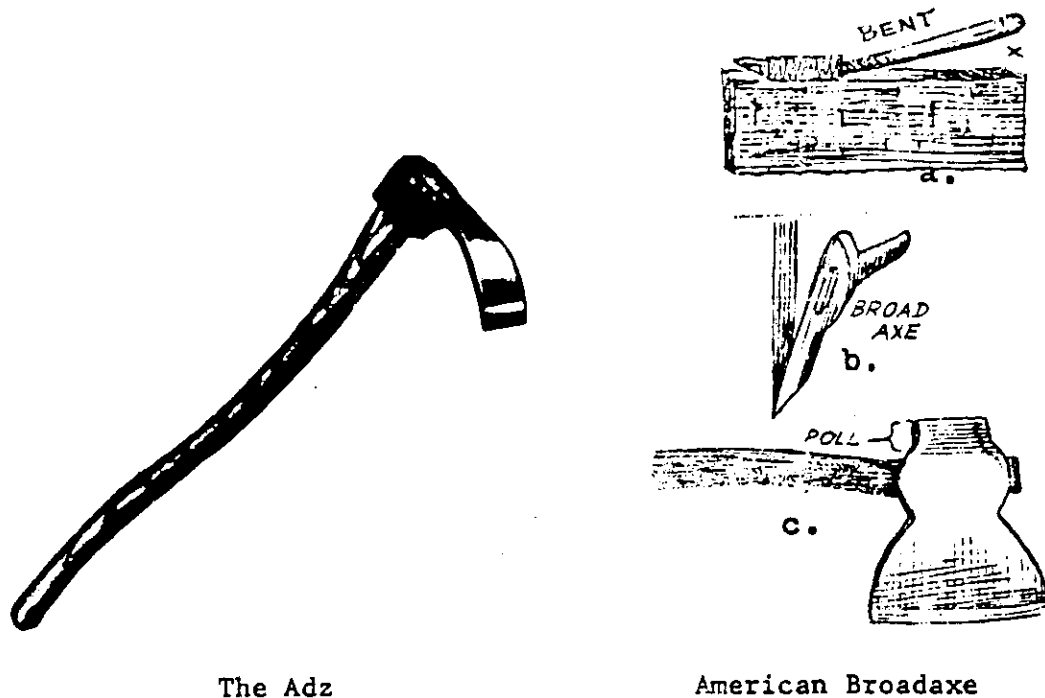

Figure 16 The Adz and Broadaxe

3. Wood Chopping Mauls (Figure 17) have become popular with the second onset of wood burning stoves. The wood chopper's maul is a wedge shaped cutting tool having a narrower, thicker and heavier head than an axe and usually weighs from 6 to 8 pounds. It has a straight handle. This type of maul is used to split logs

and trees after they have been cut down or felled. When attempting to split a log, turn the narrow end of the log down. Strike with the cutting edge of the maul to establish a notch for a wedge. Drive a wedge into the log with the sledge end of the maul until it is firmly embedded in the log. Then hit the wedge squarely with the sledge end of the maul until the log splits in half. Then the cutting edge of the maul can be used to split the remaining halves for kindling and fuel. Never use this type of maul as a wedge and strike it with another maul or hardened tool such as an axe or sledge hammer. It could crack, chip, or shatter the maul. A maul, like an axe, should be kept sharp. Dull tools tend to bounce off logs causing possible injury. Discard any maul, axe or wedge if it shows cracks, chips, mushrooming or excessive wear. Cracked or worn handles should be replaced. When using mauls and wedges, it is always a good idea to put safety first and wear safety glasses.

1. The CHOPPER 1 log splitting axe should only be used with a chopping block on solid ground.

2. Swing CHOPPER 1 axe straight over your head, striking the log as hard as possible.

3. Strike the log squarely.

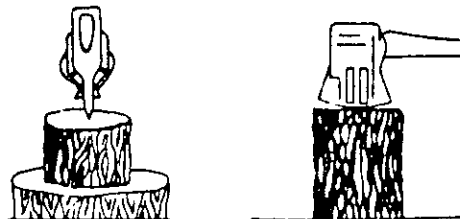

4. For large diameter logs or tough splitting woods, split segments from the circumference.

5. CHOPPER 1 axes work best on logs that are 12" to 20" long. Cut tough splitting logs shorter!

NOTE: There are some types of wood that cannot be split without the use of mechanical splitters or extreme amounts of effort.

6. If logs have knots, place knots down and perpendicular to the split line.

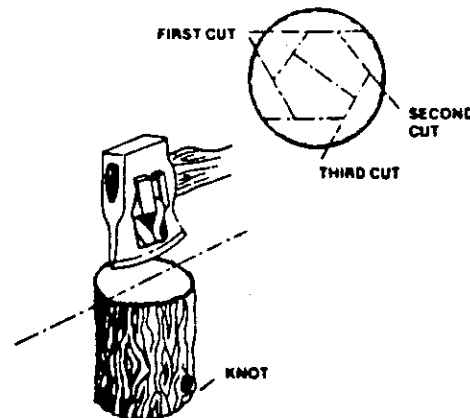

Figure 17 Wood Chopper's Maul

Figure 18 Log Splitting Axe

4. The Log Splitting Axe is a newer type of axe/maul which is designed for splitting logs and downed trees. See Figure 18. The log splitting axe is a regular axe with a mechanical device on each side of the face just above the blade. It consists of two attached metal levers which spread outward when the blade of the axe is driven into the log. The downward stroke of the

axe transforms the split into a powerful outward force. If necessary, a deeper and wider split may be obtained with each additional stroke.

5. The Hatchet is a tool of its own. Often times, the word hatchet, half-hatchet and hand axe are used interchangeably. However, each is different. The hand axe is an axe with a curved blade from heel to toe and has a short curved handle. It is a small axe. The old true hatchet is called a broad hatchet and, like the adz, it too is becoming a tool which is being used less and less. Although it is still used today, especially by construction people, surveyors, etc., who make a lot of stakes for string layouts and the like. Sometimes the cutting edge will be beveled one way or the other for the purpose of "cutting in" easier. Broad hatchets were designed with a straight blade from heel to toe, but the face is broad and shaped somewhat like a half circle. The handles are straight. The earlier hatchets were used for barrel making and shingling. These hatchets had "ears" like the Jersey axe head which were added to the head of the hatchet to hold the handle more secure so the poll could be used as a driving tool. Later on, as the old wooden shingles had to be removed and replaced, the face of the hatchet was extended pollwise to a hammer/claw type arrangement, and thus the "claw hatchet" came into being. A hatchet works best when chopping with the grain of the wood, and it is also good for heavy nailing because of the weight of the head. See Figure 19.
6. The Half-Hatchet (Figure 20) was developed from the hatchet. It is called a half-hatchet because the face does not resemble the older type broad hatchet. Instead it looks as if the head of the broad hatchet was cut vertically in half from poll to blade. Today half-hatchet blades may have a single or double bevel and the handles may be wood, tubular, solid steel or fiberglass. As tools modify and terminology changes, the catalog of hatchets may consist of many different kinds of hatchets, such as the lathing, shingling, wallboard, rigster, box, and car builder's hatchets. Many of these hatchets have had the broad quarter-circle face cut down so they are lighter, more rectangular in shape and have a narrower cutting edge. See Figure 21 for the newer type of shingling hatchet.



Figure 19 Broad Hatchet

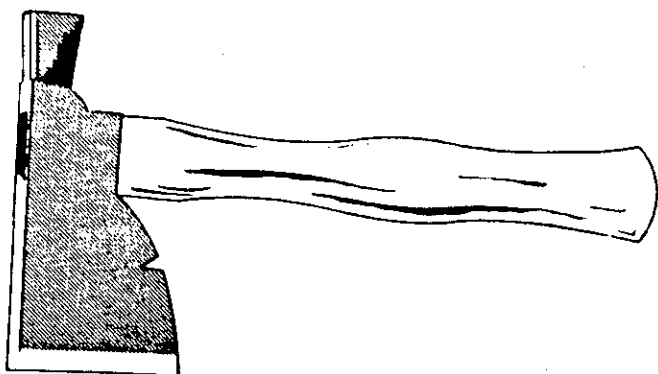
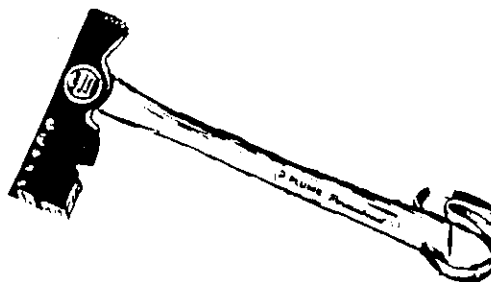

Figure 20 Half-Hatchet



Shingling hatchet with leather wrist strap. Gauge can be adjusted every half inch to lay shingles.

Figure 21 Shingling Hatchet

THE DOUBLE BIT AXE

The double bit axe is dangerous, and it is usually not a good tool for the average camper. However, it does have a place, and it does offer certain advantages to the true woodsman. For the lumberjack or experienced woodsman, the double bit axe is a symbol of true woodsmanship. The double bit axe is easier to handle and easier to use than any other. It has better balance. The weight of its head is in line with the cutting edges. It swings truer and bites deeper. Its two blades permit the keeping of one blade keen and thin for fine chopping and the other blade thicker for use around knots and near the ground where a slip means a nick. Double bit axes must always be muzzled when not in use. Helves come in various lengths, and heads come with different weights. Perhaps one of the best double bit axes is the smaller "cruiser axe." It has about a 2½ pound head with a 20 inch handle. As stated above, larger double bit axes are dangerous. It takes experience to handle them properly, and caution must always be more than exercised when using a double bit axe.

TYPES OF DOUBLE BIT AXES

There are several types of double bit axes. Theoretically, a reversible axe is a double bit axe which is a full-sized axe and is exactly the same on one side as the other. As you have seen in Figure 9, all of the double bit axes have double bits, but the only axe which is the same on the right side as the left is the reversible. Perhaps one of the most popular double bit axes is the Michigan. The swamping double bit is used for trimming, limbing or lopping. It is a lighter axe and not as heavy as the Michigan. The wedging double bit is used to separate or force apart pieces of wood, such as short sections of log which are going to be split up for stove length fuel.

AXE HANDLES OR HELVES

Wood helves, which are usually made of hickory, by their very nature are subject to wear and breakage through normal use. Handles should be examined periodically for signs of cracking, looseness or fraying. When handles become loose or worn they should be replaced immediately before accidents happen. No matter how firm a handle may be, sooner or later it will become loose. Sometimes a quick whack on the knob of the helve will tighten a loose handle temporarily. See Figure 22. Soaking the axe head in a pail of water will usually tighten a slightly loose helve, but these are only temporary measures at best.

A QUICK WHACK ON THE KNOB WILL TIGHTEN A LOOSE HANDLE TEMPORARILY.

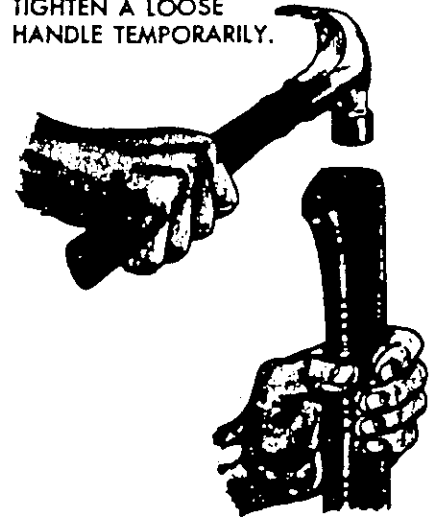
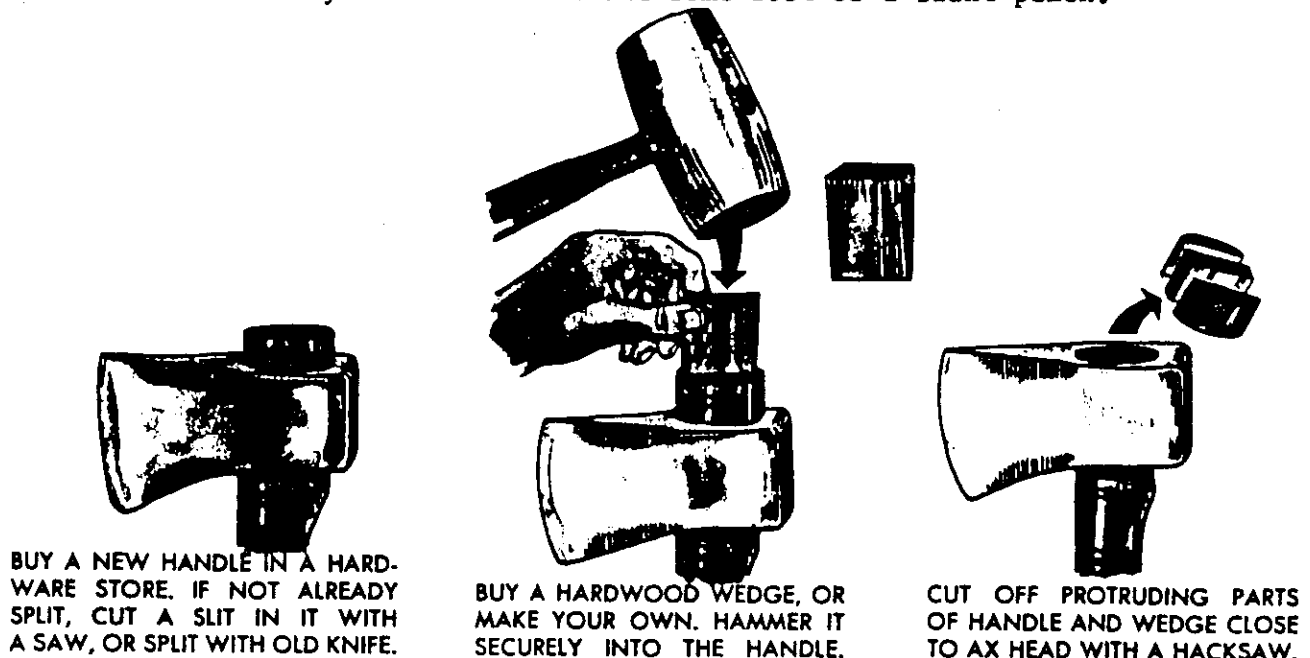

Figure 22

Rewedging is the proper way to fix a worn or loose helve. If possible, remove the head and pry out the old wedge. Get a new wedge of dry hardwood. As a rule, the hardwood wedges are better than metal ones. Replace the head and drive the wooden wedge in as far as possible. Allow the handle to protrude out the eye on the front of the head and then use the axe a little and then try driving the wedge again and saw it off as shown in Figure 23.

When a handle needs to be replaced, probably the best way to get the handle out of the eye is to cut off the handle flush with the back eye. Then put the head into a vice and drill out and knock out the remaining handle in the eye with a hammer and some sort of a blunt punch.



BUY A NEW HANDLE IN A HARDWARE STORE. IF NOT ALREADY SPLIT, CUT A SLIT IN IT WITH A SAW, OR SPLIT WITH OLD KNIFE.

BUY A HARDWOOD WEDGE, OR MAKE YOUR OWN. HAMMER IT SECURELY INTO THE HANDLE.

CUT OFF PROTRUDING PARTS OF HANDLE AND WEDGE CLOSE TO AX HEAD WITH A HACKSAW.

Figure 23 Wedging the Handle

Often times with a single bit axe an easy way is to burn it out by driving the blade into the ground and building a fire over it. See Figure 24. With a double bit axe, a little ditch would have to be dug and the axe would have to be laid across the ditch and dirt packed around each blade before the fire is made under the eye. This procedure, of course, guards the temper in the blade.



IF BROKEN HANDLE STICKS, YOU CAN BURN IT OUT. PUSH AX HEAD INTO WET EARTH AND BUILD A FIRE AROUND IT.

Figure 24

When axes or handles are new, they often times come with a "fawn foot." This term applies to the end of a single bit axe handle as seen in Figure 25. This is for appearance only and has no useful purpose. Therefore, the tip of the handle should be cut off straight to produce a flat surface for the purpose of driving the helve.



SOME AXES STILL COME WITH "FAWN FOOT" KNOBS. CUT OFF TIP WITH SAW TO PREVENT SPLITTING.

Figure 25

On a new single bit axe or when replacing the handle, it should be remembered that a correctly hung axe head is slightly off right angle to the handle. From the middle of the head to the angle of the handle should be about 85 degrees. The cutting edge of the blade should be in an exact line with the center of the handle. See Figure 26.

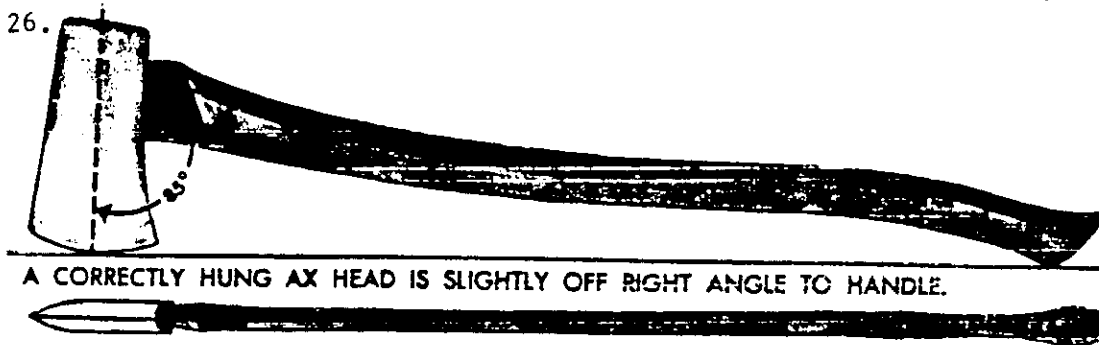

A CORRECTLY HUNG AX HEAD IS SLIGHTLY OFF RIGHT ANGLE TO HANDLE.

BIT SHOULD BE ABSOLUTELY STRAIGHT WITH THE HANDLE AND THE KNOB.

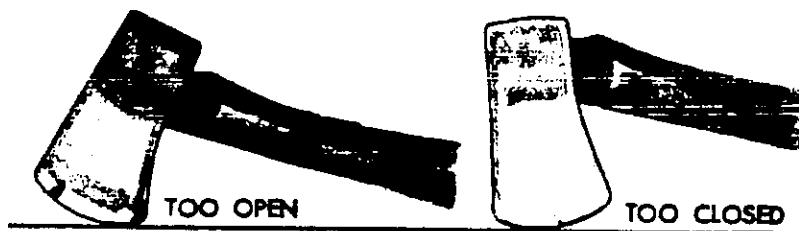

INCORRECTLY HUNG AX HEADS

Figure 26

AXMANSHIP

The essential arts of axmanship are felling, trimming, logging-up, hewing, splitting and chopping.

1. Felling a Tree Like anything else, chopping down a tree correctly takes experience and care. After a tree has been marked for cutting, the first thing to do is to check the lean of the tree and drop the tree in the direction of the lean. See Figure 27. If possible, fell a tree in the direction going with the wind, and naturally try not to get the falling tree "hung up" on heavy foliage.

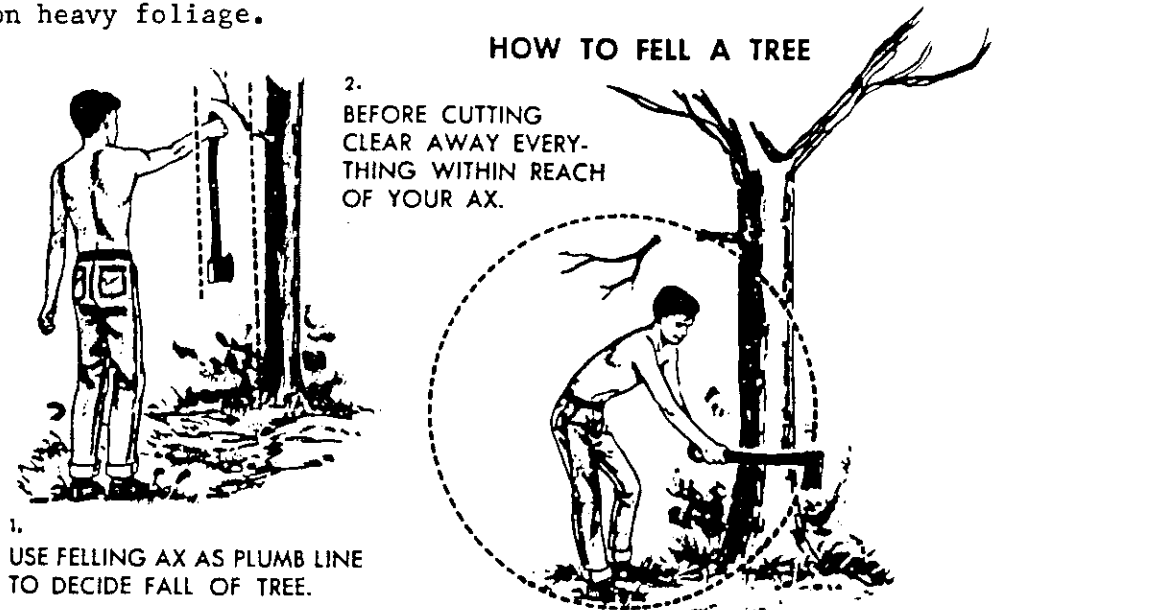
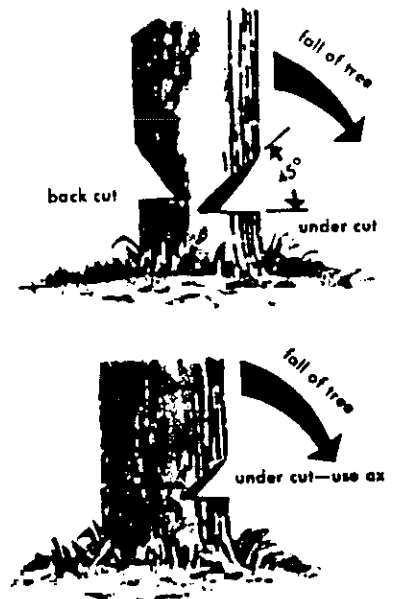

Figure 27

After these three factors have been considered, the next step is to notch the side of the tree toward which it is to fall, as indicated by the arrow in Figure 28. This is called the undercut. It should extend halfway through the tree, and the upper side of the cut should be at an angle of about 45 degrees. It is a good idea to mark the proposed notch with a piece of chalk, etc., before starting to cut. Notches of this type are called kerfs. When the first kerf is cut out, start a second back cut kerf directly opposite the first notch but 2 or 3 inches higher. Note that the kerf of both notches have a flat bottom. In chopping the notch, start at the top of the notch



3. MAKE UNDERCUT ON THE SIDE TO WHICH YOU WANT TREE TO FALL, AND BACK CUT ON OPPOSITE SIDE.

Figure 28

first. Make three cuts on the top, one on the far side, one on the near side and one in the middle. Then repeat at the bottom of the notch. Continue this method until the kerfs are completed. See Figure 29. The tree will fall in the direction of the first cut. When the tree starts to fall, and you give the call "timber", be sure to stand on either side of the tree and never behind the tree. When some trees fall, the kick-back can be dangerous if one is standing behind the tree.

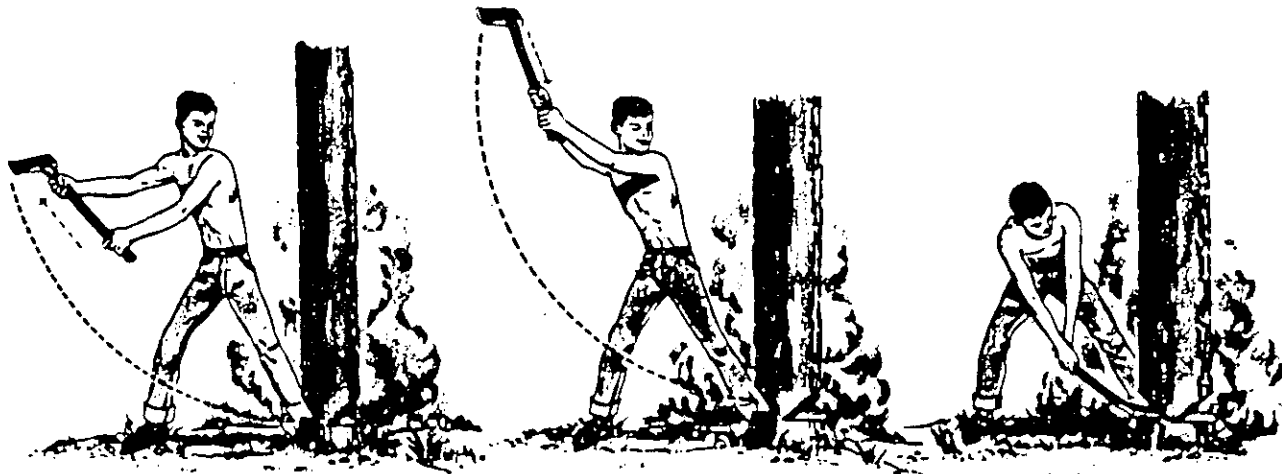

4. IN RAISING AX, SLIDE UPPER HAND AWAY FROM LOWER HAND TOWARD AX HEAD, FOR MOST EFFECTIVE LIFT.

5. AS YOU SWING AX DOWN, SLIDE UPPER HAND TOWARD LOWER HAND. WEIGHT OF AX HEAD DOES MAIN JOB.

6. MAKE DIAGONAL CUT FIRST. THEN HORIZONTAL BOX CUT. NEXT CUT THE OTHER SIDE.

Figure 29

2. Trimming a Tree Trimming branches off a fallen tree is called swamping, limbing, or lopping. Always lop branches off from the bottom of the tree towards the top. See Figure 30. Never cut down from the crotch of a branch. If a branch has to come off from a standing tree, and it is difficult to trim from the bottom, at least make a deep cut through the bark on the bottom of the branch before striking into the crotch. This prevents the bark from tearing down onto the tree trunk.

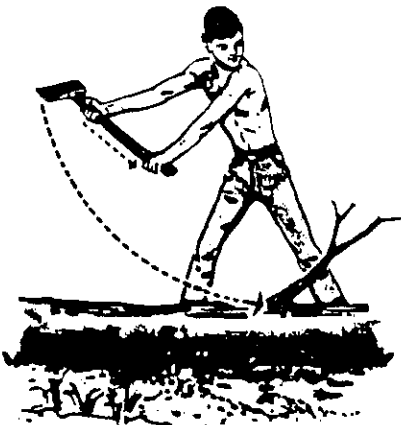

Figure 30

LOGGING A TREE IS DONE WITH V-SHAPED NOTCHES OF THE SAME DIAMETER AS THE TREE. WHEN HALF THROUGH, CUT FROM THE OPPOSITE SIDE OF TREE.

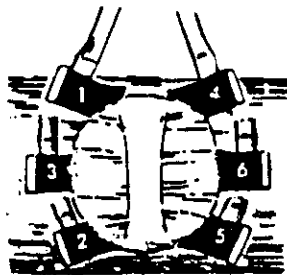
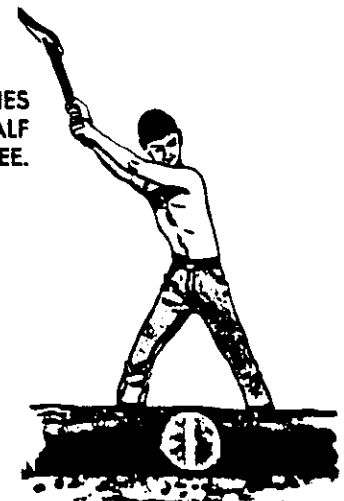

Figure 31



3. Logging-up a Tree Log-up is a term used for logging or bucking which means to cut the tree trunks into desired lengths. Logging-up a tree is done by making V-shaped notches of the same diameter as the tree. Make cuts as shown in Figure 31. When half through, the axeman should cut from the opposite side of the tree. A log or tree trunk should be chopped with the axeman standing on top of the log or behind it, and cutting through it from its sides. This eliminates having to turn logs over. See Figure 32.

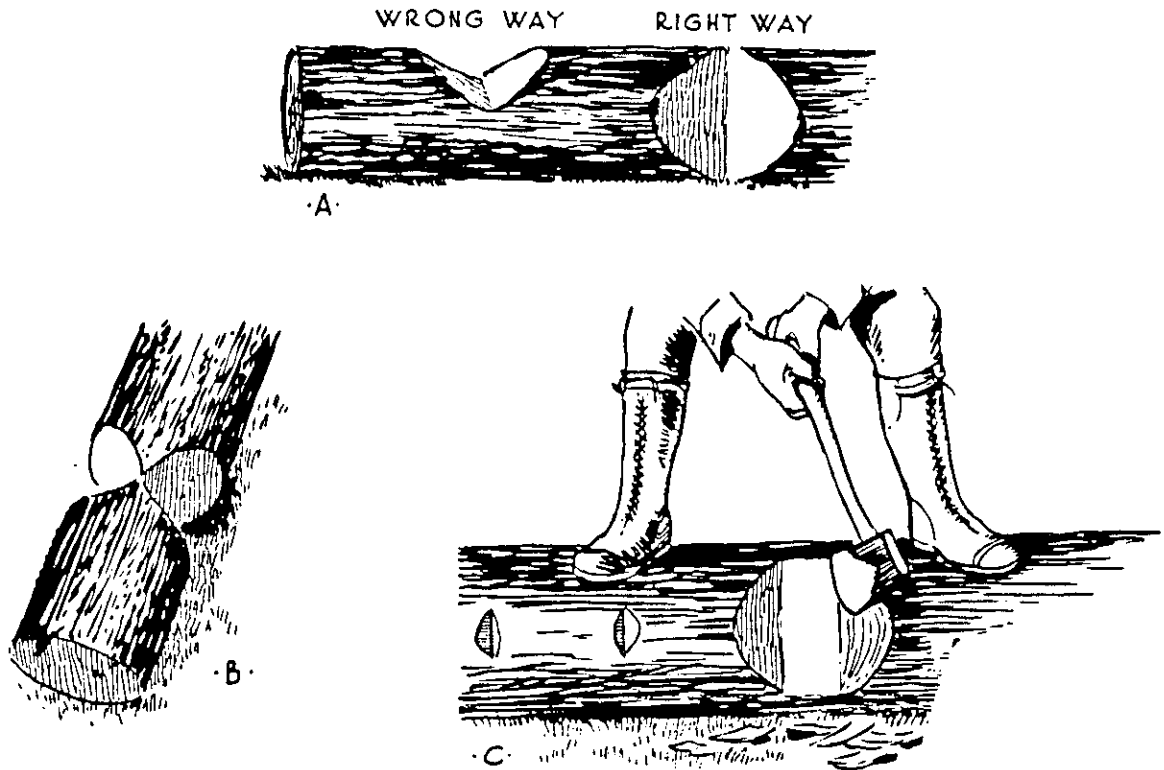

Figure 32

When chopping the V-cuts or notches, try to hit the blade at a 45 degree angle into the log. This will make the blade bite into the log much better than a straight cut into the log as shown in Figure 33. You will also find that easy gentle chopping, letting the weight of the axe head do the work rather than trying to drive and force the axe into the log, will work better. Keep your mind on swinging the axe rather than swinging it hard.

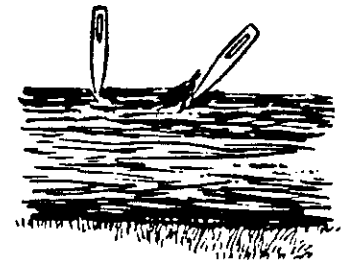

Figure 33

Hewing Hewing is flattening a log on one or more sides. Years ago this was done with an adz or broadaxe, but it can also be done with a sharp axe. First a line should be drawn on either side of the log at the point you wish to flatten. See Figure 34-A. Score the log with a series

of notches as shown in Figure 34-B. Then chop out the wood between the notches to produce a flat surface, as shown in Figure 34-C.

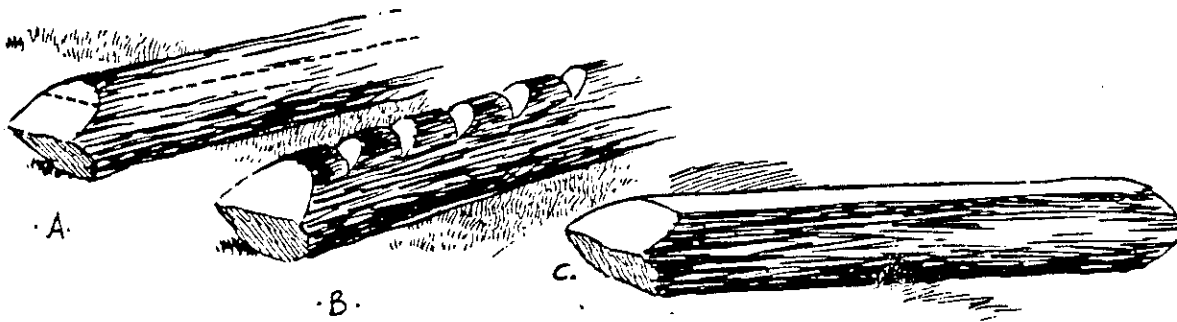

Figure 34

5. Log Splitting Even though wood chopping mauls and log splitting axes work very well, most logs can be split with 2 axes, as shown in Figure 35-A. Often times by looking for a small pre-existing split or crack, and using that niche to begin splitting, will make the job a little easier. Drive an axe into the side of the log near the end and drive the second axe in the same crack a few inches farther along, with the handle in the opposite direction, as shown in Figure 35-A. Repeat the process until the split has been completed.

Wedges may also be used for this purpose, as shown in Figure 35-B. Be sure not to use the axe as a hammer when driving the wedges. Use a sledge hammer or maul. If metal wedges are not available, you can make wooden wedges out of hardwood called gluts. If gluts are used, a beetle maul may be made for driving these wooden wedges. If the beetle is strong enough, it can also be used on metal wedges. A beetle is just a bottle-shaped hammer or club made out of hardwood, as shown in Figure 35-C.

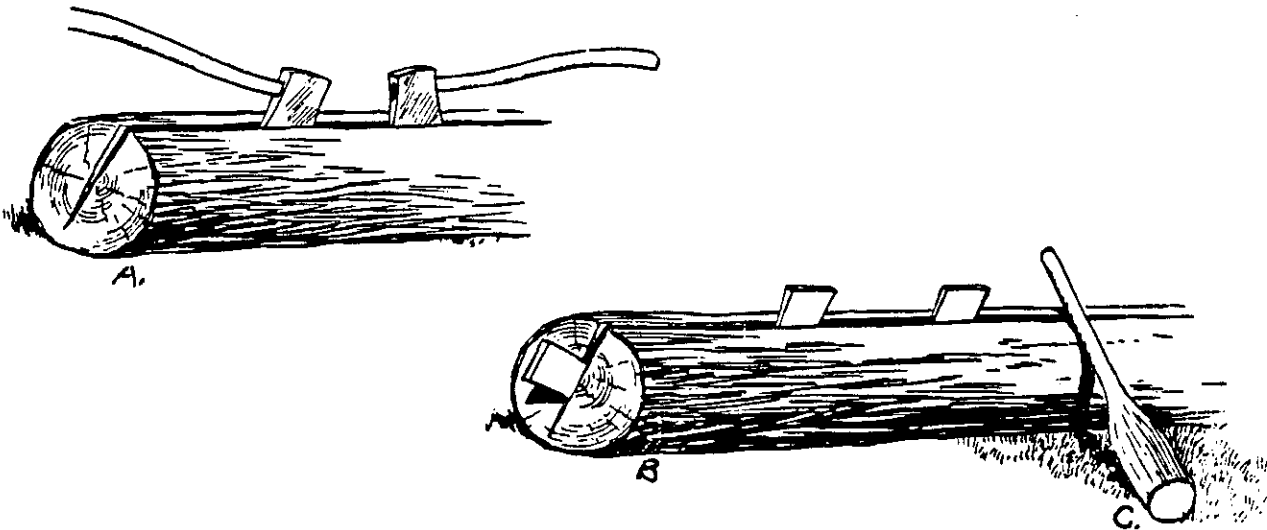

Figure 35

6. Chopping Putting "chopping" into a category of its own may be somewhat erroneous because all of the arts of axemanship constitute chopping in one form or another. Here we are probably concerned more about splitting smaller wood pieces, chopping small poles and making firewood.

In chopping and small splitting, you must have a wood support, such as a log, a Y-shaped tree crotch from a 6 inch tree or any improvised chopping block. See Figure 36. When the chopping block is not in use, it makes a good place to muzzle the axe blade. See Figure 37. When chopping limbs into smaller lengths, never chop the piece of wood while it is laying on the ground. This is a good way to nick up and dull your axe. Instead, lay the limb over a log as shown in Figure 38. Be sure the axe bites in over the point where the limb rests solidly on the log or the cut off piece may go flying in any direction. Never cut between the log and the ground. When cutting a stick you might even tuck one end under a small log as shown in Figure 39.

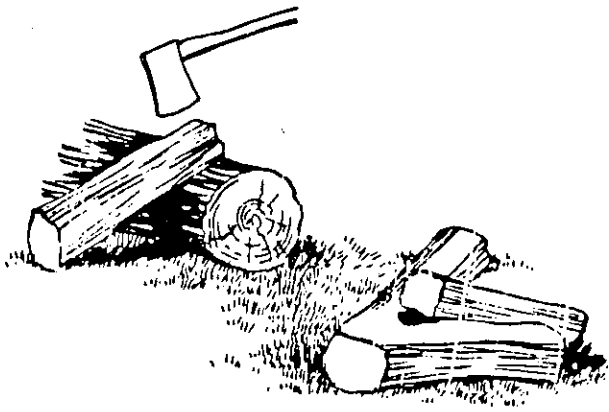

Figure 36

WHEN NOT IN USE, PUT AX
IN ITS SHEATH, OR STICK
IT IN A CHOPPING BLOCK.

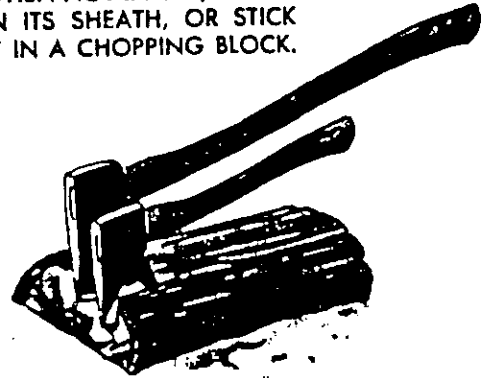

Figure 37

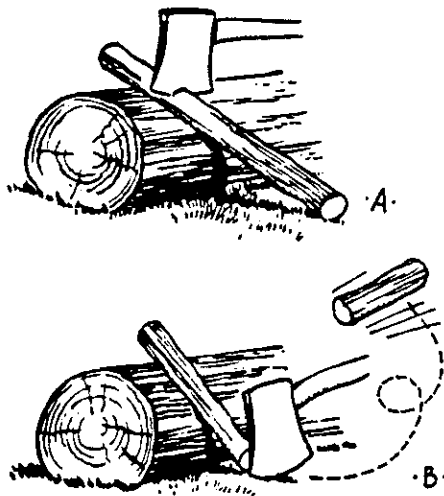
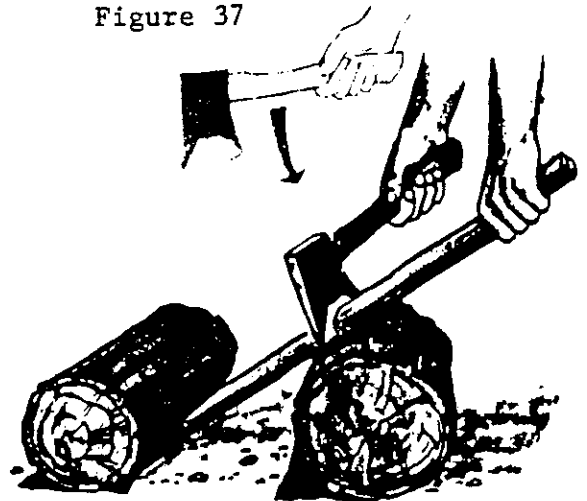

Figure 38



WHEN CUTTING STICK, ANCHOR
ONE END AGAINST A SMALL LOG,
CUT AT THE POINT WHERE STICK
RESTS AGAINST CHOPPING BLOCK.

Figure 39

If a branch is larger and cannot be cut as above, the best way is to use a V-shaped notch as shown in Figure 40.

When splitting a short log into firewood and if it doesn't split well with an axe, using a wedge as shown in Figure 41 may be the best answer. Again, do not use the axe as a maul. The poll of an axe or hand axe should never be used as a hammer. Perhaps the heaviest hammering you should do with an axe is to pound wooden tent pegs into the ground, and when this happens the pounding surface should be the face of the axe head and not the poll. See Figure 42.



USE V-SHAPED NOTCH TO CUT THICK BRANCH IN TWO PIECES.

Figure 40

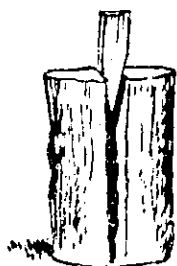
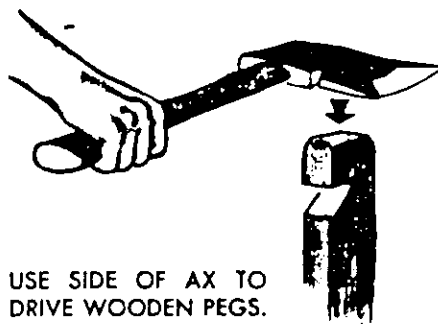

Figure 41



USE SIDE OF AX TO DRIVE WOODEN PEGS. NEVER DRIVE METAL PEGS WITH YOUR AX.

Figure 42

When splitting smaller logs, the piece to be split should be on the far side of the chopping block as shown in Figure 43-A. Never chop a smaller piece of wood using your foot as a guide as shown in Figure 43-B.

WHEN SPLITTING, PLACE PIECE AGAINST FAR SIDE OF THE CHOPPING BLOCK.

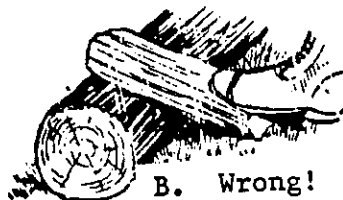

B. Wrong!

Figure 43

Another method of chopping is called the "contact method." For chopping a stick into two pieces, hold the axe edge against the stick on a slant to the grain, not straight across. Raise the stick and the axe together and bring them down hard together on the chopping block as shown in Figure 44-A. A sapling may also be split lengthwise with the contact method as shown in Figure 44-B.

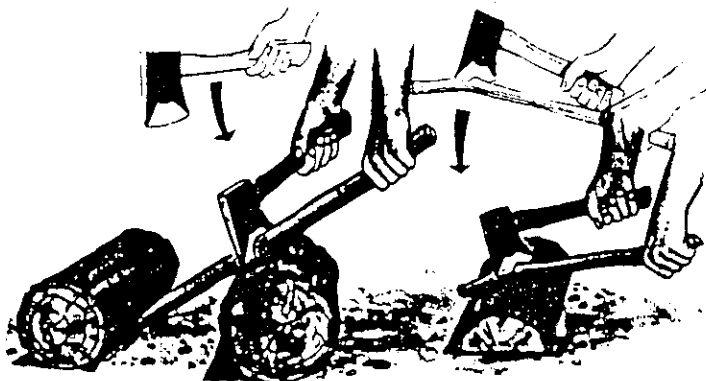

WHEN CUTTING STICK, ANCHOR ONE END AGAINST A SMALL LOG, CUT AT THE POINT WHERE STICK RESTS AGAINST CHOPPING BLOCK.

ANOTHER WAY OF CUTTING A STICK IS TO PLACE AX EDGE IN CONTACT WITH STICK AND BRING BOTH UP AND DOWN ON CHOPPING BLOCK TOGETHER.

Figure 44-A

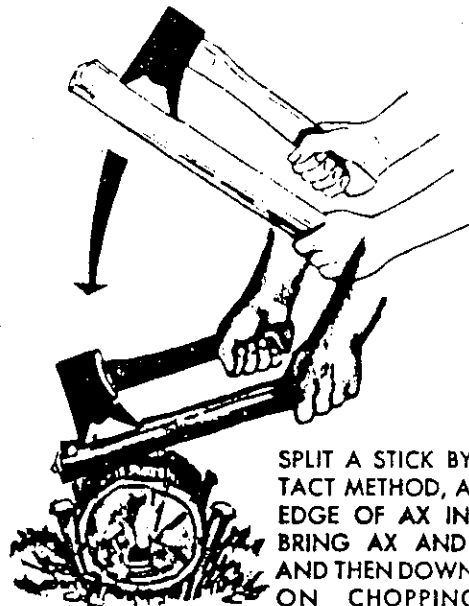

SPLIT A STICK BY THE CONTACT METHOD, ALSO: PLACE EDGE OF AX IN A CRACK. BRING AX AND STICK UP AND THEN DOWN TOGETHER ON CHOPPING BLOCK.

Figure 44-B

The axe is a special piece of equipment. You should not lend your personal axe or borrow from others. Keep the axe head in good shape. Keep the handle tight and in good condition and you will find that your axe will pay dividends.

SHARPENING THE AXE

Like a good knife, your axe should be kept sharp because dull axes cause accidents. When an axe blade is driven into a log, it should drive in - not bounce off. Even a new axe sometimes will need sharpening because sometimes the manufacturer will leave the blade somewhat blunt not knowing to what type of use the purchaser will want to put it.

Axes may be sharpened on a grindstone with plenty of water, but not on a power wheel which will remove the temper. The axe blade should be thinned down from a point about 3 inches up from the cutting edge. See Figure 45. After the axe has been properly tapered once, it should be periodically sharpened with a file. If the axe is quite dull, use a 10 inch mill bastard file. If it only needs touching up, use a 10 inch mill or second cut file. The bastard file gives a faster and rougher cut, whereas the mill or second cut file gives a finer and smoother cut. An excellent safety measure when filing an axe is to be sure your file is equipped with a handle and guard as seen in Figure 46. Wood handles with metal ferrules are easily force fitted. Slipping on a wooden improvised guard between the file and the handle pays dividends in the prevention of accidents.

One method of sharpening with a file is to lay the axe on the ground with the blade propped up on a stick or small log as shown in Figure 46.

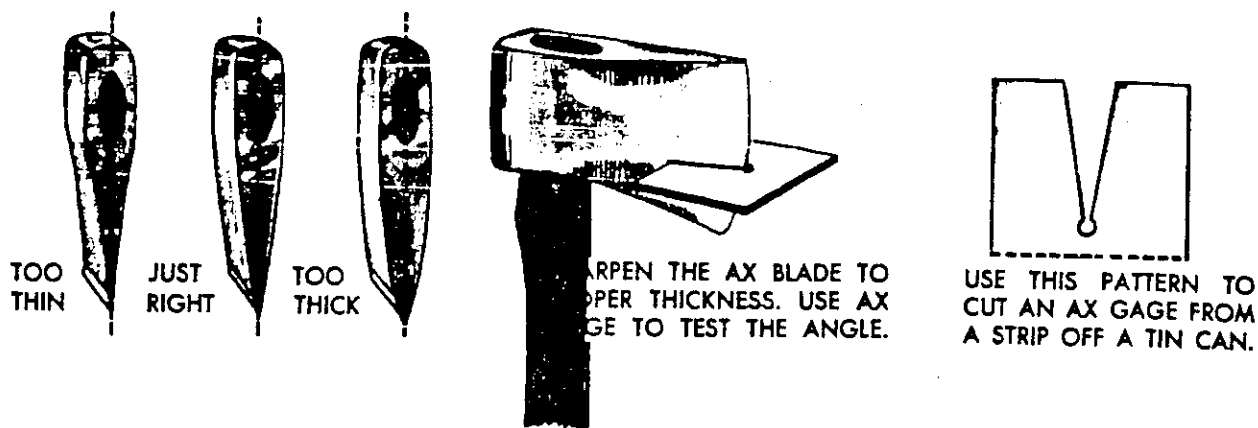

Figure 45

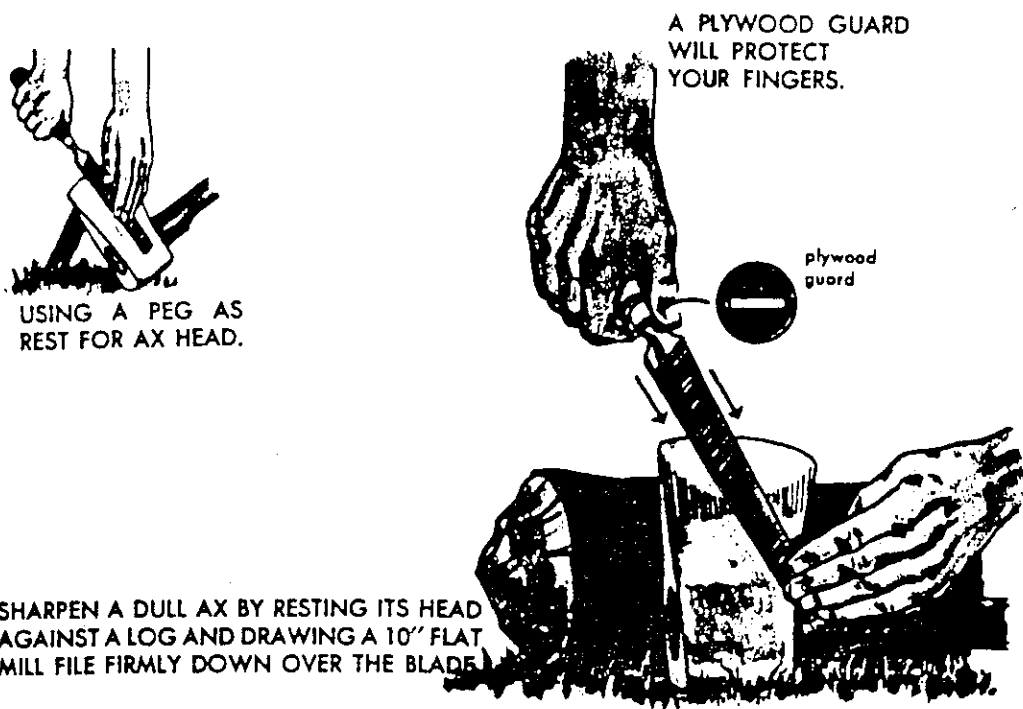
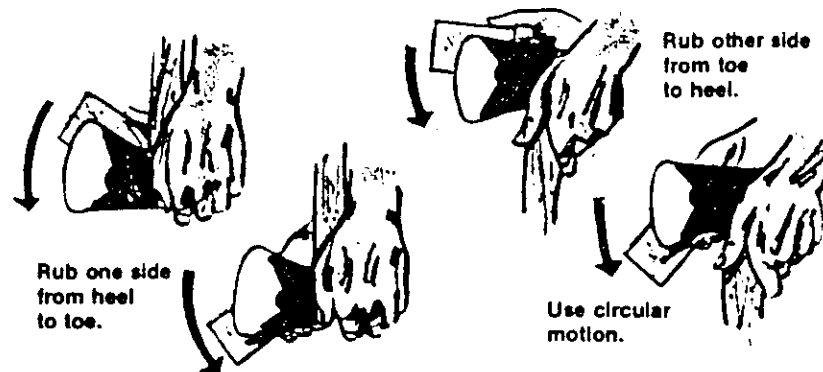

Figure 46

To steady the axe you can firm the helve against the log with a couple of pegs. Start filing at the beginning of the bevel and push toward the poll, keeping the file in contact with the edge of the blade. The axe should be kept wet and both edges should be filed uniformly on both sides. If there are bad nicks on the edge of the axe, start with a coarse cut file and then finish with a smooth cut file. When holding the axe at arms length with the blade pointing at eye level towards you, you should not be able to see the edge of the blade if the axe is sharp. Files are covered in Chapter 4.

After filing, the bevel of the cutting edge should be honed with a circular motion from the heel to the toe on each side to remove the fine wire edge that forms after your filing. See Figure 47. An axe should be honed more often than it is filed to keep it in good cutting shape. A carborundum stone is a good stone to use for axe honing.



Hone the bit of your ax regularly with a dry sharpening stone. Use the stone also for removing the wire edge that forms when you file the ax.

Figure 47 Honing an Axe

CARE OF THE AXE

There are many rules for axe care, but if you adhere to the following ten rules you will have a good start:

1. Keep the axe sharp.
2. When not in use keep the blade muzzled, sheathed or masked.
3. In carrying the axe on the shoulder, keep the blade pointed away from the body. If you should stumble, throw the axe away from the body.
4. Be sure the head is tight and the handle sound.
5. Clear brush before chopping at least 2 axe lengths in all directions.
6. When a chopper fells a tree he should stand to one side - never behind it when the tree starts to fall.
7. Keep the axe out of the sand, dirt and snow.
8. Always use a chopping block under the wood you are chopping unless you are chopping a log.
9. If you hand your axe to someone else, pass it by the handle, with the head down and the edge outward.
10. Use the contact method for chopping kindling and small fuel.

When buying an axe, decide which type of axe you want to buy. Get one that is comfortable for your stance and grip. The handle should be a good length. Shorter people usually like a shorter handle. As with a knife, the steel is the heart of the axe. Beware of the real cheap axe. They will probably have cheap steel that will chip and dent easily. They will give way to nicking and probably will not hold an edge. Buy an axe

with good balance and the best you can afford. An axe, like the knife, should be a personal piece of equipment. Don't lend it out and keep it sharp. Observe the safety rules for your own protection as well as others. A good axe, if handled correctly, will give you years of good service.

CHAPTER 3

SAWS

HISTORY AND NOMENCLATURE

Saws and axes go hand in hand. They are both excellent woods tools for cutting wood. Usually the right saw will do a far better and faster job than the axe. Saws date back to over 1000 B.C., but it was the Romans who discovered and were first to use the set. The set is the way in which the teeth of a saw are bent slightly outward to the left and to the right so that the saw makes a little larger groove, or kerf, which prevents the saw blade from binding. The kerf is the width of the cut made by a saw. Figure 48-A shows the teeth shape and kerf of the hand saw.

The work done by the cutting teeth and the rakers of a timber saw is shown in Figure 48-B, which shows four cutting teeth between two rakers or drag teeth. Two of the teeth (A and B) are filed so that the points of the teeth make a cut like a knife cut at the right side of the saw kerf, and the other two (C and D) at the left.

For our purposes, most saws are made up of a steel blade and a handle which may be of wood, plastic or metal. See Figure 49. The long edge of one side of the blade is marked with a series of teeth which make up the cutting edge. These teeth are pointed toward the heel or toe of the saw. This is called the rake. If the teeth rake toward the toe of the blade, the saw cuts on the push motion. On the other hand, if the teeth rake toward the heel of the blade, the saw will cut on the pull motion. If the teeth have no rake, the saw will cut on both the push and pull motion. The fewer teeth the saw has, the rougher the cut. The more teeth a saw has, the finer and more accurate the cut.

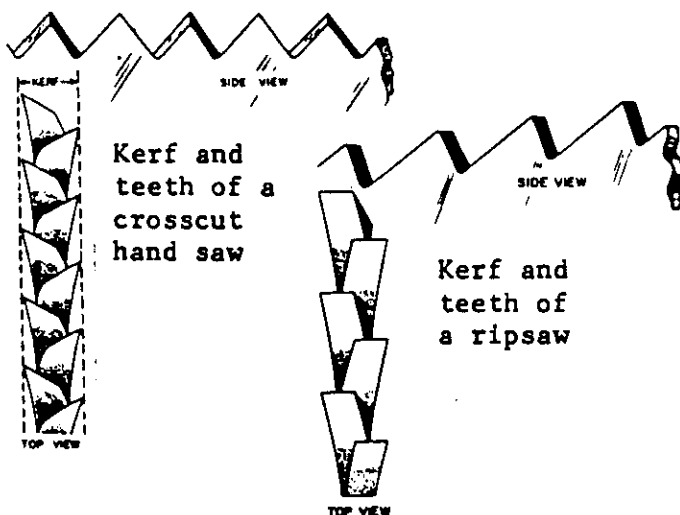

Figure 48-A The Teeth and Kerf of a Hand Saw

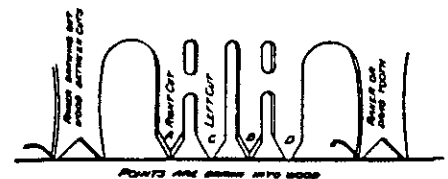

Figure 48-B The Pulp Blade (Lance-Tooth) of a Timber Saw Showing the Work Done by the Cutting Teeth and Rakers

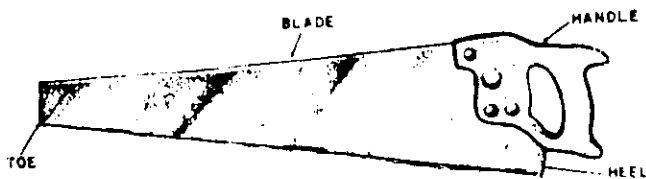

Figure 49 Parts of a Saw

As an example, the carpenter's crosscut handsaw, which is used for cutting across the grain, has 7 to 11 points per inch. The teeth are bevel-filed like knives. A rip saw is designed for cutting with the grain of wood and usually has $5\frac{1}{2}$ points per inch and the teeth are cross-

filed like chisels. See Figure 48-A. A handsaw with 12 points per inch is usually used for finishing. If you should want only one saw for all purposes, get one with 8 points to the inch. This would be used for both ripping and cross cutting. A saw with a wide set and coarse teeth is needed for cutting green unseasoned wood.

TYPES OF WOOD SAWS

If we stay away from the various saws used by the carpenter, plumber and other tradesmen, we can concentrate on the saws of the woodsman. The true woodsman who likes to dally in the woods without the conveniences of electricity and power tools should keep his eyes open for various types of saws.

THE LARGE TWO-MAN CROSSCUT TIMBER SAW

This is a double handled saw used for heavy work such as felling trees, cutting up large logs or making timber for construction. See Figure 50. The blade usually runs about 5 to $6\frac{1}{2}$ feet in length and the saw is operated by two men, one on each end and each pulling the saw towards himself. The saw is never pushed. This is called riding the saw and causes the saw to buckle and complicates the sawing procedure.

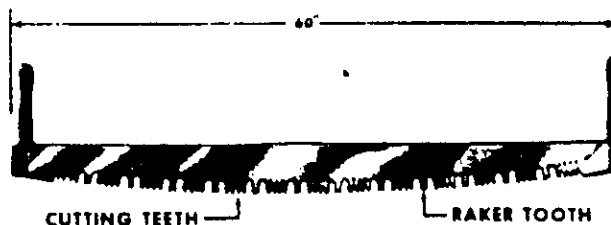

Figure 50 Two-Man Crosscut Saw

Large crosscut saws are ground so the teeth are a uniform thickness along the entire length. The back of the saw is usually crescent ground so the ends are thick and the middle is narrow. This method gives stiffness to the saw, prevents binding and permits the saw to have a minimum set. This type of saw may come with perforated lance teeth with 4 teeth per raker or with a tuttle tooth pattern of two cutting teeth per raker.

THE LARGE ONE-MAN CROSSCUT TIMBER SAW

This saw, seen in Figure 51, is usually about 36 to 48 inches long. It also has two handles, one of which is shaped like that of a handsaw. The other is detachable and is clamped to the top edge of the saw. This handle may be placed either at the heel of the saw for a one-man operation or near the toe for a two-man operation. The one-man saw is operated like the handsaw, using the detachable handle on the heel side of the blade, so it may be used as an aid in pulling the saw back. When used as a two-man saw, with the handle at the toe end, it is used as described for the two-man crosscut saw.

This saw usually has lance teeth with deep gullets for maximum removal of sawdust when cutting large logs.

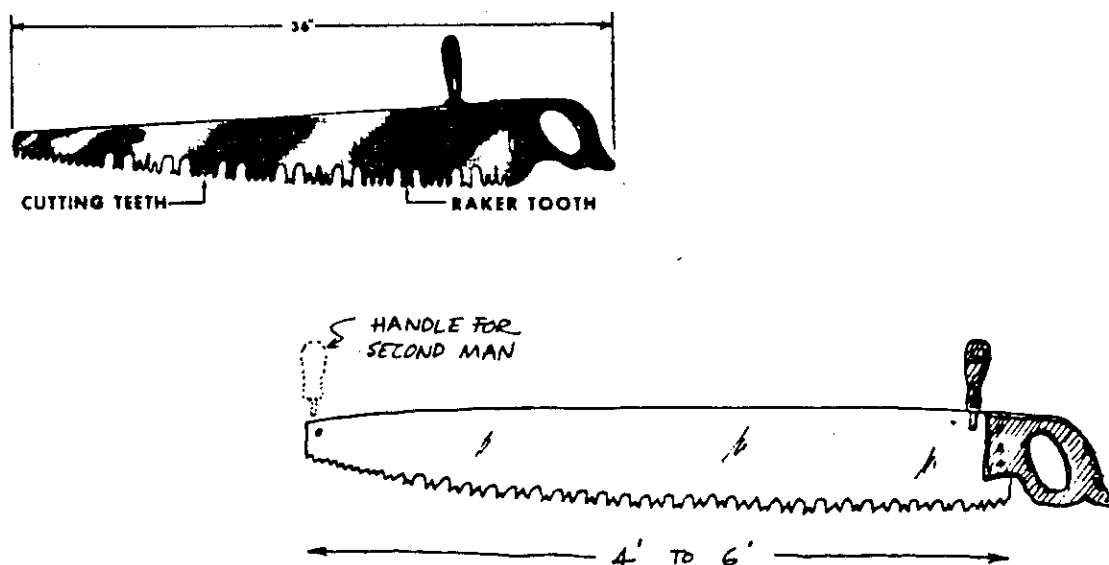

Figure 51 One-Man Crosscut Timber Saw

THE FIVE-PIECE BUCKSAW

Probably the best known bucksaw is the old fashioned five-piece model with wooden frame and a turnbuckle at the top to tighten the blade. See Figure 52. This was popular a generation or two back, but if you look around you can still find these saws.

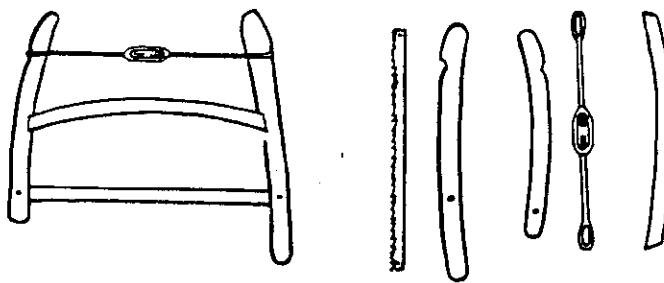
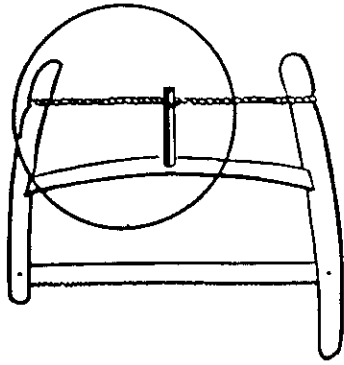

Figure 52 The Five-Piece Bucksaw



ON A BUCK SAW WITHOUT A
TURNBUCKLE, KEEP THE BLADE
TAUT WITH A TWIST ROPE

Figure 53 Field Repairs on the Five Piece Bucksaw

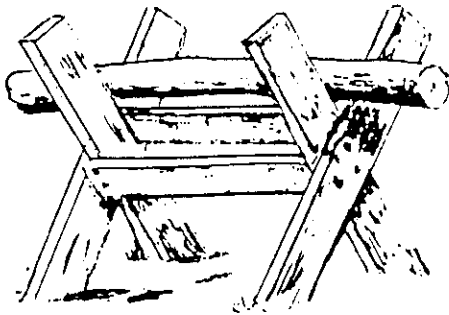

Figure 54 Sawhorse or Sawbuck

The old bucksaw had a plain V-shaped toothed blade. The frame was hardwood, easily repaired or replaced in the woods. Even the turnbuckle could be replaced by a rope and small piece of branch as shown in Figure 53. More often than not, the bucksaw was used with the sawbuck or sawhorse as shown in Figure 54. The sawbuck is discussed in more detail on page 42.

Even though the old bucksaw is becoming an antique, and is being replaced by tubular and chain saws, there is a new modern collapsible bucksaw as shown in Figure 55. This saw can be taken apart and wrapped together and it will take up a lot less space than a regular tubular steel framed bow saw.

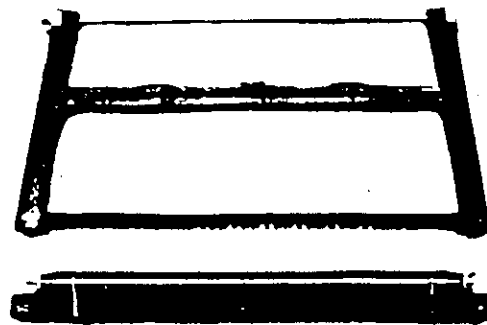

Figure 55 The Modern Collapsible Bucksaw

THE TUBULAR BOW SAW

Bow saws with their tubular frame and tension clamping levers are considered an upgrade from the old bucksaw. One type of bow saw has a collapsible steel frame held together with a metal sleeve which joins the two pieces of frame. This makes it easy to carry and a good saw to pack. See Figure 56. Another good feature of some bow saws is an extension of one end of the steel frame below the level of the blade which is used as a handle. This is seen on the collapsible bow saw in Figure 56. This is one of the bad features of many of the bow saws. They are often called "knuckle busters" because you have to grasp the frame immediately above the blade, and when sawing, quite often you jam your knuckles into the piece of wood that you are sawing. Sometimes an extension piece of wood can be driven into the open end of the tubular frame. This will allow you a handle to grasp below the blade and prevent knuckle wounds. Each company makes their tubular bow saws a little different shape, but basically they are all pretty much the same. It makes a good saw to have around the axe yard.

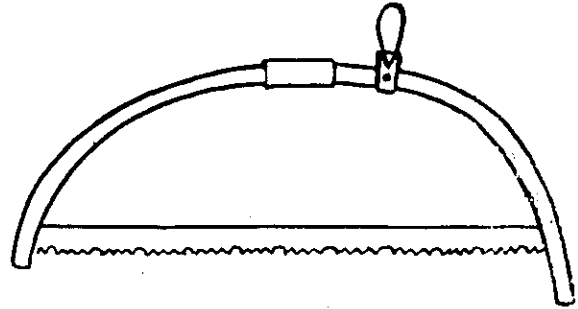

Figure 56 The Collapsible Steel Frame Saw

BOW SAW BLADES

There are different types of cutting edges on bow saw blades. Three of the most popular types are the straight V-tooth blade, the pulp blade (better known as the "4 tooth raker") and the bushman tooth blade. The V-tooth blade is the slowest, toughest and the best for the beginner. The pulp blade has a raker tooth between every 4 cutting teeth. (In some saws there may be between 2 and 5 teeth). This blade rakes the sawdust from the saw kerf. The bushman blade is a fast cutting blade characterized by a curving sweep of the points. See Figure 57.

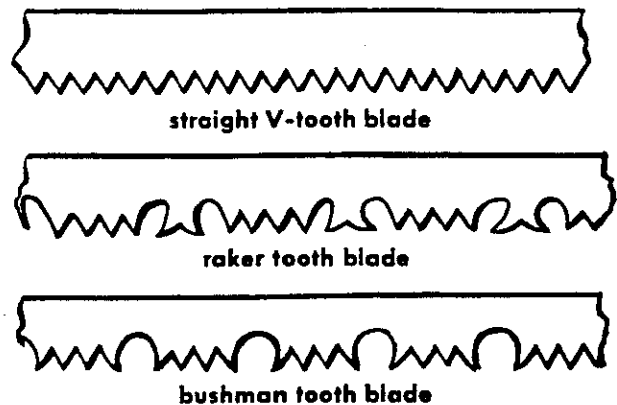

Figure 57 Bow Saw Blades

THE TRAVELING SAFETY SAW

This saw makes an excellent saw to carry for long term camping or long hiking treks where you will need a good saw for lighter work. It folds up nicely to carry in a pack and still makes a rugged saw with a good sized blade. See Figure 58-A.

The folding pack saw is just right for overnight camping. For a longer-lasting camp you may want the safety saw. This also folds up.



Figure 58 Safety Saw and Pack Saw

THE FOLDING PACK SAW

The folding pack saw is not nearly as good as the traveling safety saw, but it makes a saw for light work on short term campouts when there is a minimum of sawing anticipated. The saw blade folds into the handle and can be tossed into a pack taking up a minimum of room. See Figure 58-B.

SURVIVAL-TYPE SAWS

Survival-type saws come in an array of shapes and designs. Some of these saws are very good with a cutting edge on each side of the blade. One cutting edge is usually used for rougher cuts and a finer blade for finer cuts. Many of these saws have good steel with the Rockwell hardness stamped on the blade. See Figure 59.

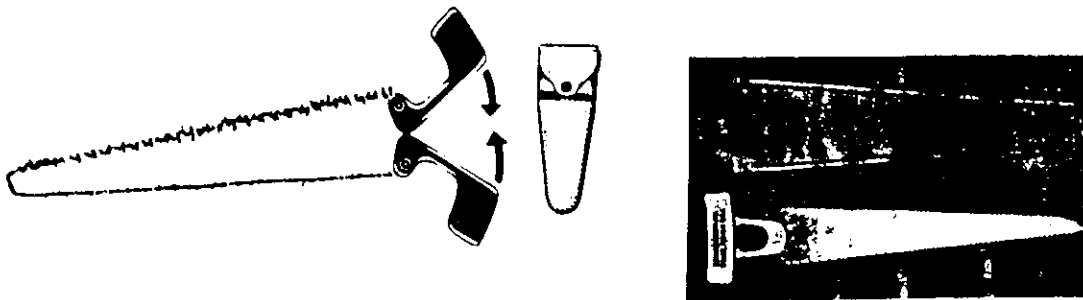
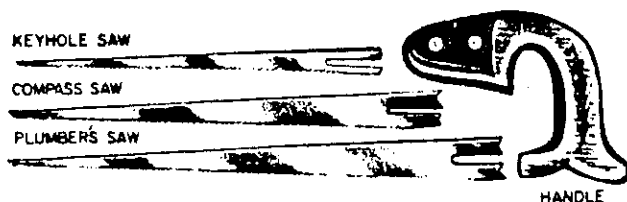

Figure 59 Survival-Type Saws

NEST OF SAWS

Some people prefer a "nest of saws." There are several types on the market, and each nest has their own particular blades. Originally, a pack



of nested saws consisted of a handle and three interchangeable blades. Usually there were a keyhole saw, a compass saw, and a plumber's saw which was used to cut through nails and soft metal. Today nested saws can have any type of blade, including such blades as a handsaw blade, a pruning blade, a metal cutting blade, or most any other type of blade. If

Figure 60 Nested Saws

you can put these nested blades into a holster they are not a bad group of saws to have along. See Figure 60.

CABLE SAW

The small cable saw is another type of survival saw. It has been called a giggly, thumb saw, commando saw, wire saw, pocket saw, survival saw and other names too numerous to mention. It is nothing more than a piece of thin roughened cable about 12 inches long with a ring or handle on each end.

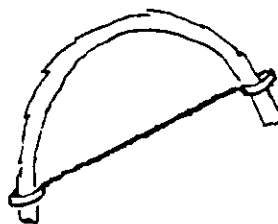
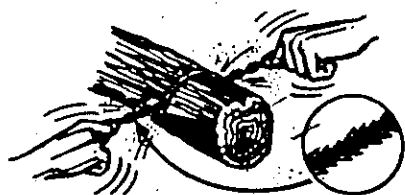

One Handed Use

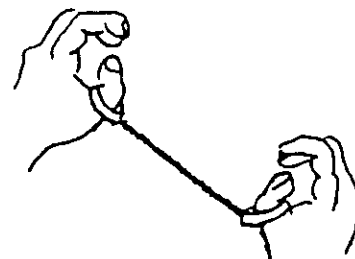

Two Handed Use

Figure 61 Cable Saw

By placing your thumbs in each ring and extending the cable blade until taut, you can saw with a brisk back and forth motion. You can also make it into a one-handed saw by using a green tree branch about $\frac{3}{4}$ inch in diameter and five inches longer than the saw. With the ends of the branch as in Figure 61, attach the second ring over the notch on the opposite end.

UTILIZING THE SAW

As with the axe, so with the saw - easy does it. When sawing, have the wood to be sawed held firm and use smooth easy strokes without downward pressure on the saw. Whenever using a saw, whether hand saw, bow saw or other, if the blade starts to bind you must always use some type of wedge

in the saw track which will spread the kerf and give the saw more room. See Figure 62.

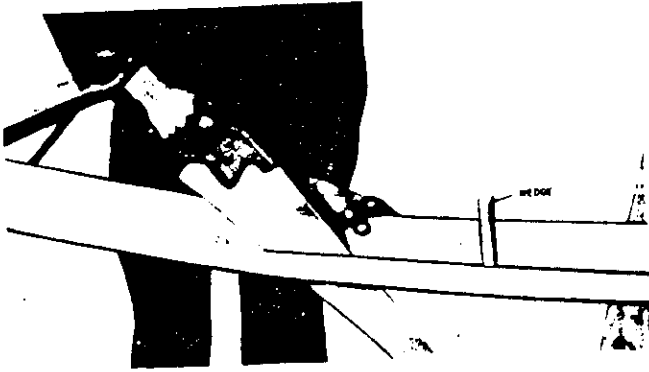

Figure 62 Preventing a Saw From Binding



Place the wood you are cutting so that the cut end falls free of the support.

Figure 63 Cutting Small Poles

One method of cutting small poles or firewood is to lay one end of the piece to be cut over a small log. Kneeling on your right knee, place the left foot over the other end to help hold it steady. Then with your left hand also helping to immobilize the piece to be cut, saw the end of the wood off at the desired length so that it falls free of the log. See Figure 63. If you are left handed, do it in the opposite manner.

THE SAWBUCK OR SAWHORSE

The old sawbuck was a wood rack with X-shaped ends. The two ends were held together with a few pieces of planking or 2 x 4's. Wood was laid across the sawbuck for sawing by hand. See Figure 54. Cutting wood into logs or small pieces with a bucksaw was called bucking. Bucking wood with a sawbuck or sawhorse is still probably one of the easiest ways of sawing wood. The height of the crotch of the sawbuck should be about 16 inches so that the log to be cut will be at a convenient height so it can be steadied by hand, foot or knee. The width of a sawbuck should be from 18 to 24 inches. If desired, the X-shaped ends can be driven into the ground a short way, crossed to make the X on each end over a large log and then the uprights can be spiked into the log, as shown in Figure 64-A, or it may be fixed with a joining pole as shown in Figure 64-B.

Another type of sawbuck is shown in Figure 65. As you can see by the drawing, one person can roll a large log into the sawing position quite easily. The log can then be pinned at the desired position and the log will not roll down.

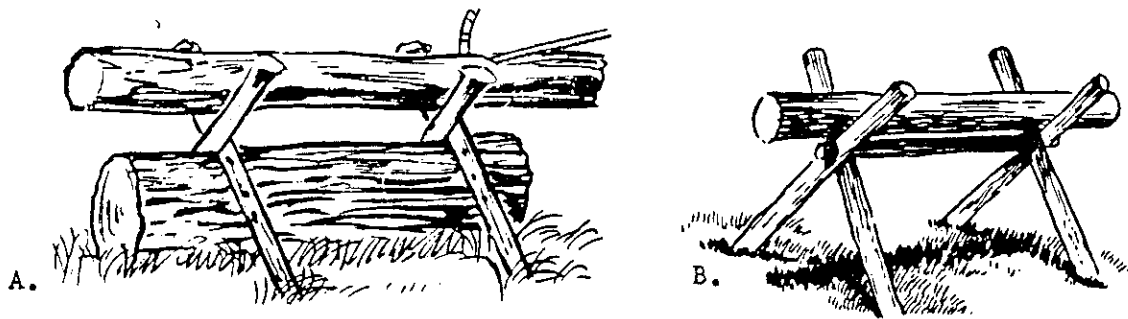

Figure 64 Sawbuck or Sawhorse

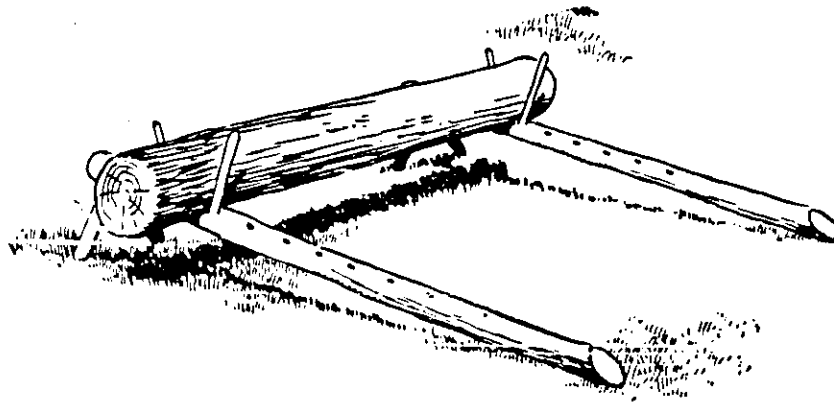

Figure 65 A Sawbuck for Heavy Logs

FELLING TREES WITH A SAW

When using a saw to fell trees, you must follow the basic rules that are used with the axe, taking into consideration the lean of the tree, the surrounding area and even the direction of the wind. Remember that when it begins to fall stand to either side of the tree and never behind it.

CARE OF THE SAW

A few of the basic rules in caring for a saw are as follows:

1. Hang up the saw when not in use.
2. Keep it out of the dirt, rain and snow.
3. Protect the saw blade from getting bent.
4. Protect the teeth from losing their set.
5. Do not cut into nails or metal with a good saw.
6. Cover the blade with a guard or piece of tubing which has been split when the saw is not in use.
7. Do not allow the blade to strike the ground when sawing.
8. A strip of waste should not be twisted off with the blade, but instead broken off with the hand or a mallet.
9. Wipe the blade occasionally with an oiled rag to help prevent rust. Once a blade starts to rust, its tough to restore.
10. Keep the saw blade sharp.

SHARPENING THE SAW

Sharpening a saw should be left to the expert who has the knowledge and tools to do the job. There are many different kinds of teeth on saws, and for the most part sharpening should be handled by the man with the know-how. However, sharpening the various kinds of teeth can be done with a little practice.

First, for the plain V-shaped teeth, use a 6 inch tapered single cut triangular file. This would include handsaws, bucksaws and most saws with the plain V-shaped teeth. Remember that on a crosscut saw the teeth are bevel-filed like knives and are designed to slice the wood's fibers. On a rip saw, the teeth are cross-filed, like chisels. In effect, they chisel their own way through the wood. See Figure 66.

On saws with larger teeth, such as a bow saw, the teeth can be touched up with an ignition file. However, you must be careful to make the file strokes so that they follow the bevel of each tooth. Do one side of the blade and then the other. See Figure 67.

If the saw teeth get bent from having something heavy fall on them or if the saw is dropped on the teeth, sometimes the set can be readjusted with a pair of pliers; but as stated above, usually best results are obtained when repairs are done by the expert.

Each individual has to purchase a saw for his particular purpose. For the woods, it is difficult to beat the collapsible buck saw.

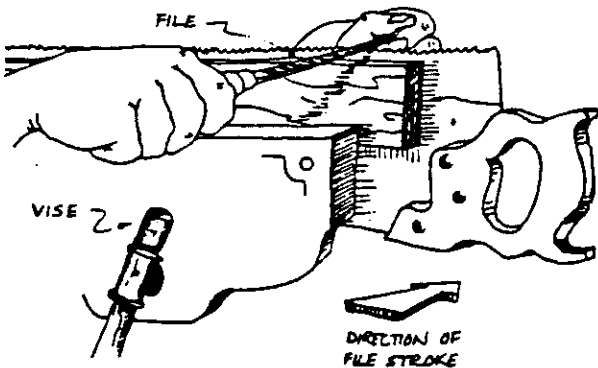

Figure 66 Sharpening a Saw With V-Shaped Teeth

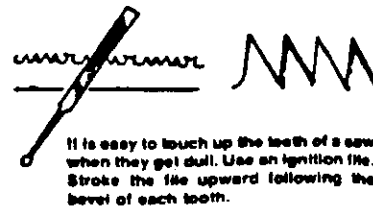

Figure 67 Sharpening a Saw With Larger Teeth

CHAPTER 4

TOOLS AND SIMPLE MACHINES FOR THE WOODSMAN

INTRODUCTION

If adults and kids like to have fun and adventure in the woods, you need a few tools for grubbing out campsites, building rustic furniture, setting up just plain old "fun things" and erecting pioneering projects. Where kids are involved, it is usually better to stay away from the power tools. Besides, both kids and adults can have a lot of fun building rafts, towers, runways, tripods, gin poles and various bridges with the simple, yet effective, tools of yesterday and today.

When we speak of pioneering, we are talking about the person or group that originates or helps open up a new line of thought or activity. This type of pioneering gives elementary training in building, in stress and strain, and in force and balance. It stimulates the imagination for survival technics, for improvisation and ingenuity. It teaches teamwork, resourcefulness and discipline. It is practical and character building.

Tools and supplies are not always at a premium, but with a little scrounging and proper inquiries, the necessary equipment and materials may be found for almost any project at little or no cost. Supplies are always needed. Nails, spikes, lag screws, bolts, clamps, cable, chain, rope, timber and numerous other things will be needed for special projects, but as mentioned above, with a little searching, these things can be found at a cheap price.

It should go without saying that in any type of construction, safety-first must be of prime importance. The proper care in the use of tools and equipment is of utmost importance. Misuse can readily cause injuries, so you must always keep the safety factor in the foreground.

HANDTOOLS

Some of the best tools for building pioneer projects in the wilderness are categorized and listed here. Sketches of the tools are shown in Figures 68 thru 85.

1. Cutting Tools:
 - Knives
 - Saws
 - Drawknife
 - Machete
 - Bolt Cutters

2. Driving Tools:
 - Curved claw hammer
 - Blacksmith's Double-faced Hammer
 - Wooden Mallet
 - Sledge Hammer

3. Chopping Tools:
 - Axes
 - Adz
 - Hatchets
 - Hand Axes

4. Drilling and Boring Tools:
 - Brace and Bits
 - Hand Drill with Bits

5. Measuring and Layout Tools:
 - Tape Measures

6. Digging and Grubbing Tools:
 - Shovels
 - Post Hole Auger
 - Pick Mattock
 - Grub Hoe
 - Cutter Mattock
 - Sickle & Scythe

7. Sharpening Tools:
 - Grindstone
 - Files
 - Hone

8. Specialty Woods Tools:
 - Cant Hook
 - Peavey
 - Timber Carriers (Lug Hooks or Telegrips)
 - Hoists
 - Cable Gripping Tools
 - Pulleys and Block and Tackle
 - "Helper" Bars and Levers

9. Miscellaneous Small Tools:
 - Wrenches
 - Pliers
 - Screw Drivers

The tools listed above may seem like an impressive set of woods tools - and they are - but many of these tools can be picked up very cheaply at garage sales, flea markets and farm auctions. They certainly do not have to be purchased new! Some tools such as the timber carrier,

can be made if you have a friend who can do some cutting and welding. Revamping a pair of old ice tongs can make a good set of telegrips. Most people are acquainted with the tools mentioned above, but some of them may warrant a little more explanation than just a picture.

DRAWKNIFE OR DRAWSHAVE

The drawknife, also called a drawshave, is seen in Figure 68. It is an older tool which has a heavy steel blade and two hardwood handles. It is a sturdy, well balanced knife used for rough sizing and shaping of wood and for cutting down corners and edges. It is excellent for debarking and hewing. It comes in various sizes and it is designed to be pulled toward the user, not pushed. The depth of the cut is regulated by tilting the blade. It is still used by furniture makers.

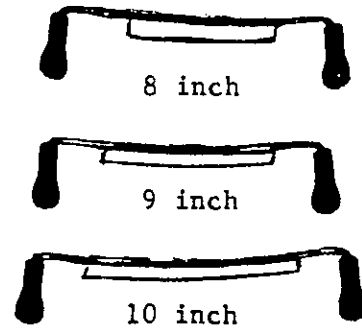

Figure 68 Drawknife

ADZ, MATTOCK AND GRUB HOE

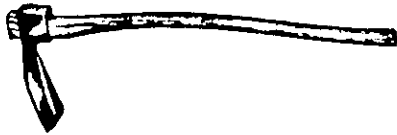

Figure 69 Wood Dressing Adz

The wood dressing adz as shown in Figure 69 is discussed in Chapter 2. There is also a railroad adz, but both of these tools are about the same in construction and design. The blade has a timber cutting edge.

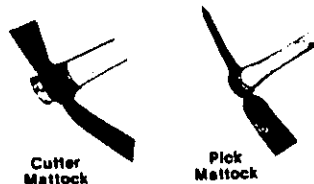

Figure 70 Pick Mattock

Closely related to the adz is the mattock. Mattocks can be of several designs. There is a garden mattock, a pick mattock and a cutter mattock, etc. The garden mattock is light weight and is used for gardening. The pick mattock is seen in Figure 70 and is used to aid in digging into hard ground. The cutter mattock is used more for grubbing and rooting and digging up topsoil. Often times the handles for a pick and cutter mattock are interchangeable.

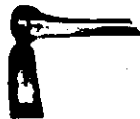

Figure 71 Grub Hoe

The grub hoe in Figure 71 is very similar to the adz. The adz has a poll whereas the grub hoe does not. The grub hoe is used for rooting and grubbing and the adz is used to hew lumber. Its cutting edge is much sharper. They look very much alike, but their uses are very different.

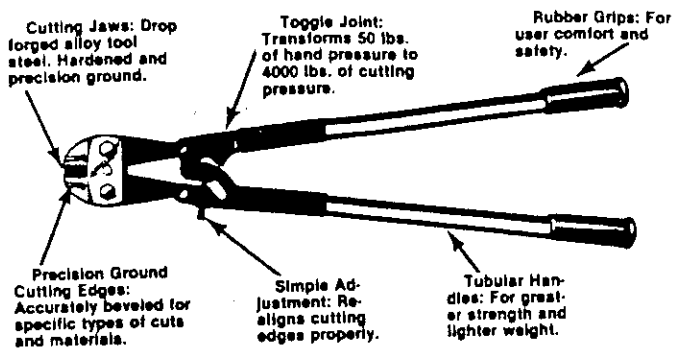

Figure 72 Bolt Cutters

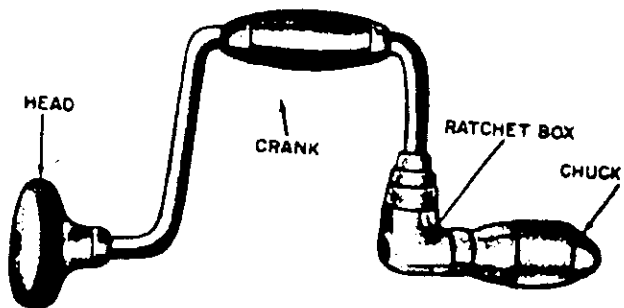

Figure 73 The Brace



Round Point with Long Handle



Square Point with "D" Handle

Figure 74 Shovels



Hamline Post Hole Digger

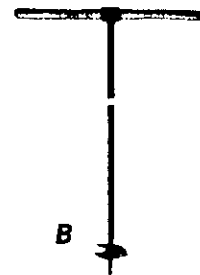

Vaughan Post Hole Auger



Telescoping Earth Auger

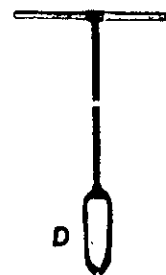

Universal Earth Auger

Figure 75 Post Hole Auger

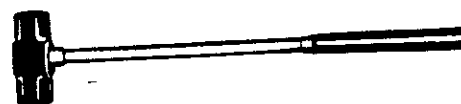

Figure 76 Blacksmith's Double-faced Sledge



Figure 77 Wooden Mallet

Figures 72 thru 77 are sketches of various woodsman's tools which are self-explanatory.

FILES

The nomenclature of a file is shown in Figure 78. A file is a sharpening tool which deserves a little explanation because there are so many different kinds of files and so many different uses for them. To start with, rasps have teeth and files have ridges. There are hundreds of different kinds of files, sizes and cuts. There are files for every purpose. They are used on hard metals, soft metals, wood, leather, plastics and a host of other things.

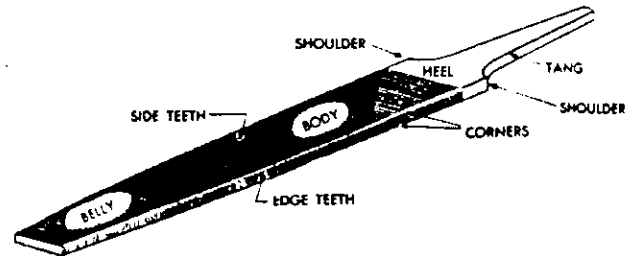

Figure 78 File Nomenclature

Basically, for our purpose, most "American Pattern" files are distinguished by four things - length, shape, coarseness and cut. The length of a file (usually from about 4 to 16 inches) applies only to its cutting surface from the point to the heel. The shape of a file refers to its cross-sectional shape. That is, it may be square, rectangular, round, half-round, triangular, knife shaped, etc. The cut refers to the type of serrations or ridges it has - a single cut file has ridges running diagonally across it, whereas a double-cut file has a second set of ridges running in an opposite diagonal across the first. Coarseness of files are usually graded as: "Bastard Cut" for heavy removal with a coarse finish, "Second Cut" for light removal with a fair finish and "Smooth Cut" for fine finish work. As a file's length increases, its cut becomes coarser because a shorter file has many more ridges and serrations per inch, and as a result it is much smoother than a longer file of the same type.

Probably the two best files for the woodsman's tools are the "flat" file and the "mill" file. Flat files have a double-cut and are used with heavy pressure for rough finishes. Mill files have a single-cut and are used with lighter pressure for smoother finishes. These are also used chiefly for sharpening cutting surfaces. However, each file (mill and flat) has its own 3 grades of coarseness - bastard, second cut and smooth cut. The mill file is so called because it was used in sawmills for sharpening saw blades and typically tapers in its forward third.

An 8 to 10 inch mill file would probably be the best choice of a file to use for sharpening woods tools. However, to do a good job, you should have at least one each of the three grades of coarseness. Second and smooth cut files are not always stocked by local hardware or auto supply stores. If not, you can usually find a "fine" grade mill file.

As stated in the preceding chapter, a good file for v-shaped saw blade teeth is a 6 inch tapered single-cut triangular file and for the bushman and raker teeth blades of a bow saw, the best file is an ignition file.

CANT HOOK AND PEAVEY

The cant hook or peavey (also spelled peavy), Figures 79 and 80, are closely related. Usually if you have one you don't necessarily need the other; but usually you need two in order to move logs any distance. These tools are used for moving and handling heavy logs, poles and beams. Each tool combines fine balance with great strength. The cant hook has a lip at the distal end of the toe ring which digs into the side of a downed tree trunk, and a curved hook ending in a sharp point set at right angles to the line of the hook, which digs into the side of the trunk opposite the lip. This enables you to take a firm grip on a tree trunk or log and by working the lever handle, you can maneuver the trunk into the position you want. The peavey is about the same as the cant hook except that there is a sharp spike at the end of the lever instead of a lip. Figure 80-A shows the peavey. The point on the peavey is used chiefly for maneuvering logs in the water. The peavey invention has been credited to Joseph Peavey, an American blacksmith.

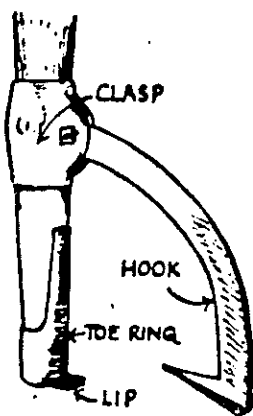

Figure 79 The Cant Hook

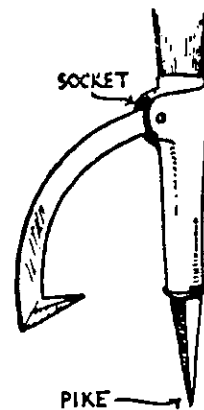

Figure 80 The Peavey

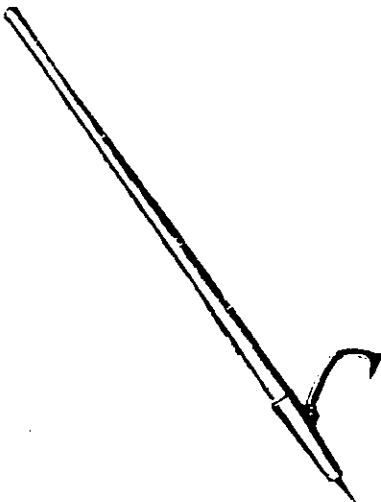

Figure 80-A The Peavey

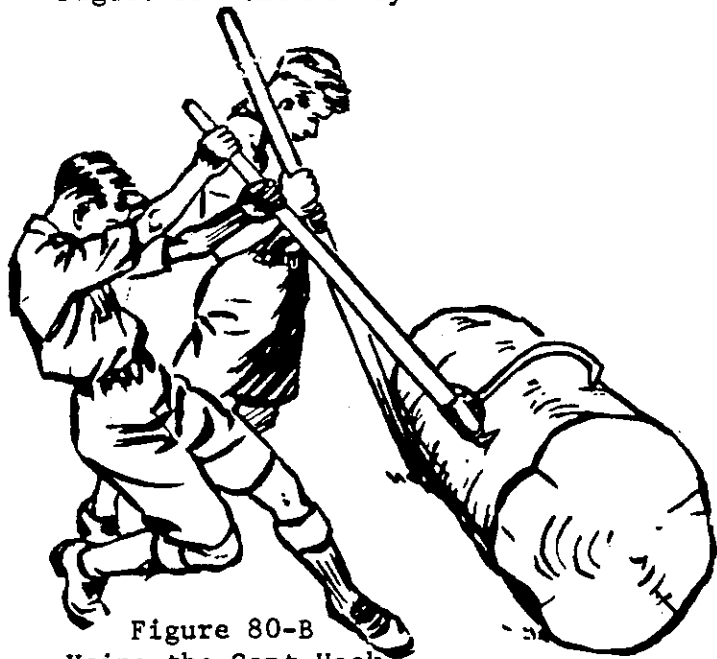

Figure 80-B
Using the Cant Hook

LUG HOOKS

With lug hooks or telegrips (Figures 81 and 81-A) four people can carry a lot of log. You may also improvise telegrips, as shown in Figure 81-B.

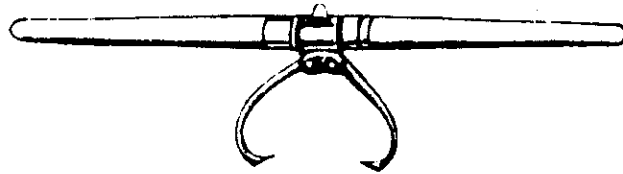

Figure 81 Lug Hooks (Timber Carrier)
or Telegrips

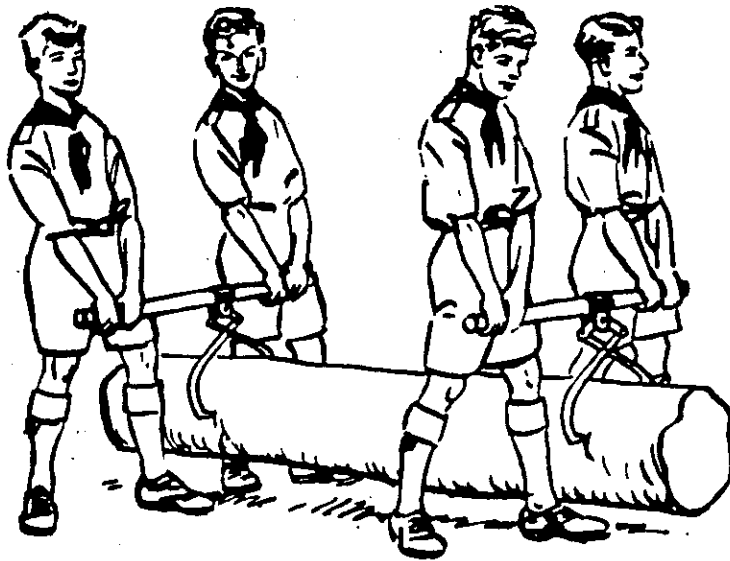

Figure 81-A Telegrips
In Action

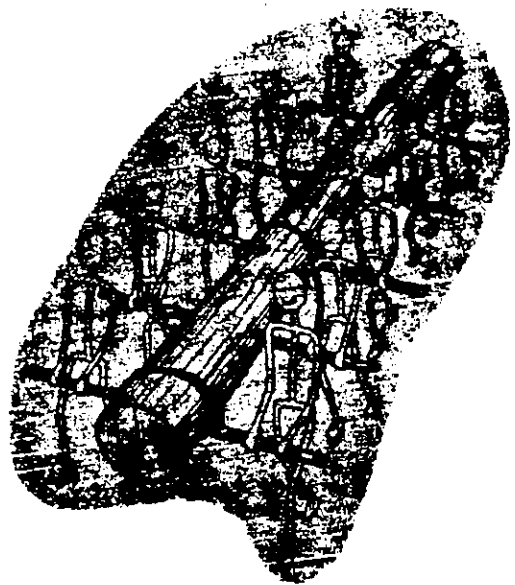

Figure 81-B Improvised Telegrips

THE HOIST, CABLE-GRIPPING TOOLS AND WIRE ROPE SLINGS

Most of us are familiar with the 3/4 ton to 2 ton winch-hoist as shown in Figure 82-A. Many people refer to it as a "come along." It is an excellent tool for tightening rope or cable.

If you want to make a permanent structure with a taut cable, you almost need a pair of cable-grippers as shown in Figure 82-B. These are used chiefly by utility, communication and construction workers where cables have to be tightened. They are used to pull bare stranded or solid wire or cable and maintain temporary tension until it can be permanently terminated with some type of clamp. These steel grips are used for tightening only, and are not used for permanent anchoring.

Another handy gadget to help things along is to have a wire rope sling, as shown in Figure 83. This can be used to put around a tree and it will make a solid anchor while tightening. The hoist would be placed between the sling and the cable or rope to be tightened.

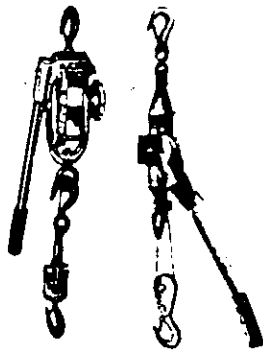

Figure 82-A Winch-Hoists

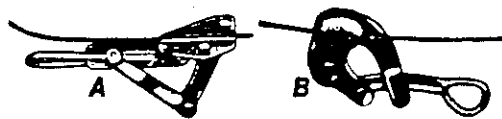

Figure 82-B Two Types of Cable Grippers

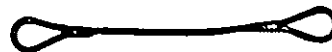
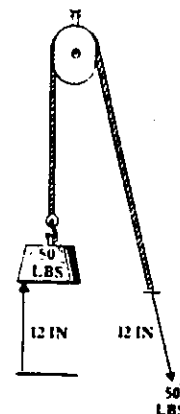

Figure 83 Loop and Loop Wire Rope Sling

THE PULLEY AND THE BLOCK AND TACKLE

A pulley is a wheel with a grooved rim used with rope, chain or cable to change the direction and point of application of the pulling force. A simple fixed pulley as shown in Figure 84-A has a work ratio of 1-to-1, or a mechanical advantage of 1. A mechanical advantage of 1 means that there is actually no mechanical advantage, except that in changing the direction of the effort force, a man pulling down on a rope from a fixed pulley can better use the weight of his body in lifting the load.

The block and tackle is a machine used for moving weights. It is made up of a rope which has been reeved through a group of fixed and/or movable pulleys



Simple Fixed Pulley
Figure 84-A

arranged in such a way as to increase the mechanical advantage. The pulleys of this type are called blocks and the rope is the tackle. A single block has one pulley, a double block has two pulley wheels and so on. A running block is attached to the object to be moved. A standing block is fixed to some stationary object. A snatch block is a single block with the shell opening at one side to admit a rope without passing the end of the rope through. A simple tackle consists of one or more blocks reeved with a single rope.

Blocks ordinarily consist of 4 parts: (1) the frame or shell - the length of the frame determines the size of the block, i.e. a 12 inch block is a block with a frame 12 inches long; (2) the sheave or wheel over which the rope passes; (3) the pin or axle on which the sheave turns; and (4) the strap of iron which passes around the shell and forms attachments for a hook at one end and an eye at the other. This is called the becket. The shell may be either wood or metal. The sides of the frame are called the cheeks of the blocks. The holes through which the rope enters the block are called the swallows. The opposite side of the block, where the rope comes out, is called the breach. A block may take its name from its particular use, its shape or the place it occupies. Most types of blocks may be single, double, treble or fourfold, depending upon the number of sheaves in the block. Some of the different types of blocks are shown in Figures 84-B and 84-C.

The process of passing a rope through blocks to form them into a block and tackle is called reeving. This is usually done by placing the two blocks to be used on the ground, with hook ups about 4 feet apart. Take the end that is to be the starting end and enter it into the swallow of the sheave you intend to lead the hauling part out of and reeve off the tackle counterclockwise. When the standing part comes to an end, splice or hitch it into the becket of the block to which it is made fast.

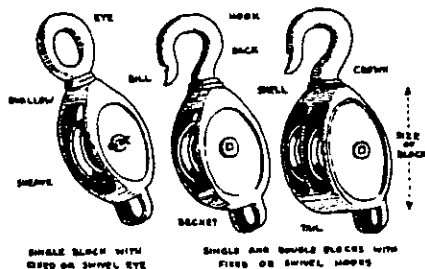

Figure 84-B
Nomenclature of Blocks

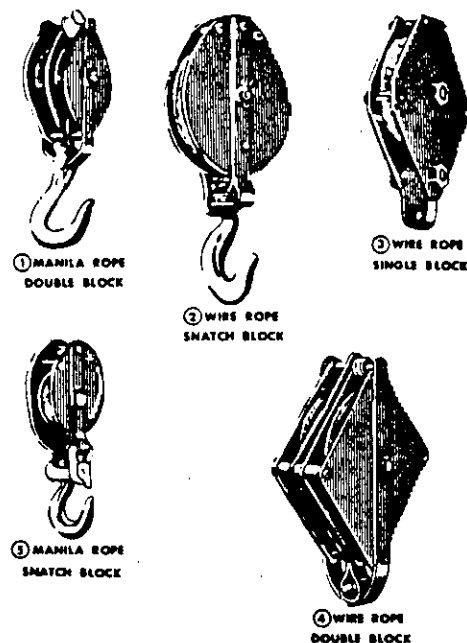
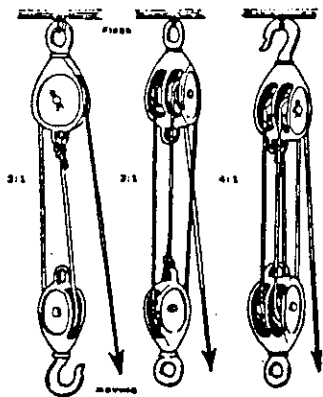

Figure 84-C
Types of Blocks

A quick way of determining the mechanical advantage of a block and tackle is to count the number of times the rope supports the weight being lifted. Count all ropes between the blocks but do not count the pull rope. Figure 84-D shows a block and tackle with a mechanical advantage of 2-to-1 and another with a 3-to-1 and one with a 4-to-1. Figure 84-E shows a block and tackle that has a mechanical advantage of 5.

In computing the mechanical advantage (MA) of any combination of machines, the mechanical advantage of each machine is computed first, and then they are multiplied together. In the diagram in Figure 84-F the MA of the upper set of pulleys is 4 and that of the lower set is 5 because the pull rope from the first set of pulleys becomes a weight bearing rope. The total MA is therefore 4×5 , or 20.

What you gain in mechanical advantage, you give up in distance. For example, a mechanical advantage of 5 means that you can lift 5 times as much, but you only raise the load 1/5 of the distance. (In other words, when you pull 5 feet of rope the weight only raises one foot as shown in Figure 84-E.) Therefore, to determine the length of rope to be used, you must first determine the mechanical advantage, and second measure the number of feet the standing block is above the ground load. The length of rope will equal the mechanical advantage, plus 1, times the number of feet. The "one" is added because when you start you need a pull rope from the standing block to the ground.



Mechanical Advantage
Figure 84-D

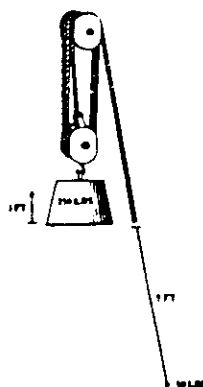

Block and Tackle With A
Mechanical Advantage of 5
Figure 84-E

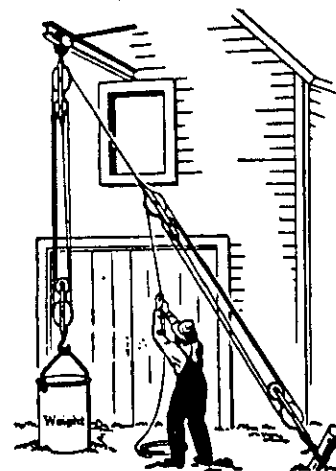

MA Equals 20
Figure 84-F

HELPER BARS AND LEVERS

Figure 85 shows pictures of three "helper bars". Figure 85-A shows a pinchbar which is a steel rod, usually of 3/4 inch material, with one end pointed and the other end wedged shape. The pinchbar is used for prying, as in opening boxes and loosening boards.

Figure 85-B shows a picture of a crowbar. This is a heavy steel bar about 5 feet in length. It is used as a lever for moving heavy objects short distances. It is also used for prying loose heavy boulders and for breaking up hard earth formations in digging.

Figure 85-C shows a gooseneck wrecking bar. Wrecking bars may be straight, claw and pinpoint, or goosenecked. In either case, the

wrecking bar has a claw at one end. The other end is wedged shaped and bent at a slight angle to the bar. This tool is used to remove nails or spikes from boards and for prying boards loose.

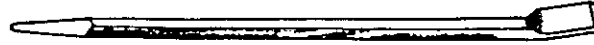

A. Pinchbar



B. Crowbar



C. Goose Neck Claw and Pinch Bar

Figure 85 Helper Bars and Levers

SIMPLE MACHINES AND MECHANICAL ADVANTAGE

Many of the tools listed above may be classified as simple machines. They make work easier by increasing the mechanical advantage. Work involves the application of force to move something, whether its driving a nail or moving a building. Physicists usually speak of six simple machines which can aid us in doing work. These are:

1. Levers, such as the crowbar, shovel, pliers, wheelbarrows, etc.
2. The Wheel and Axel, such as a windlass or that used in raising water from an old fashioned well.
3. The Pulley, such as used in the block and tackle arrangement.
4. The Inclined Plane, such as raising a load by placing a board or plank between the ground and the position to which one wishes to raise the load.
5. The Wedge, which can be used to raise a heavy load or to split a log by driving it forward or inward with blows from a hammer or mallet.
6. The Screw, which is actually an inclined plane wrapped around a pedestal such as an ordinary screw or a jackscrew.

These simple machines or devices can be used to vary the ratio between a load and the effort used to move the load. The mechanical advantage then, is the "ratio" of the load to the effort which is required to move the load. All of the above machines and most of the tools listed above have a distinct mechanical advantage. For example, the mechanical advantage of a simple screw is approximately the ratio of the circumference of the screw to the distance between the threads. A quarter-inch screw with 40 threads to the inch has a mechanical advantage of about 30 - 5.

There are many simple devices that can be built which will help do the work. We will list just a few of them.

LIFTING AND MOVING LOADS

With elementary knowledge of rigging, ropes, tackle, timbers, etc., devices can be made to assist greatly in lifting or moving heavy loads. A few of these devices are the lever, parbuckle, gin pole, "A" frame, shear legs, tripod, lifting hoist, windlass, makeshift tackle and boom derricks. Most of these simple machines are self-explanatory from the illustrations. However, we might say just a few words about some of them.

LEVERS

A lever, as shown in Figures 86 and 87, is a rigid object arranged to turn on a fixed support, which is called the lever's fulcrum. The

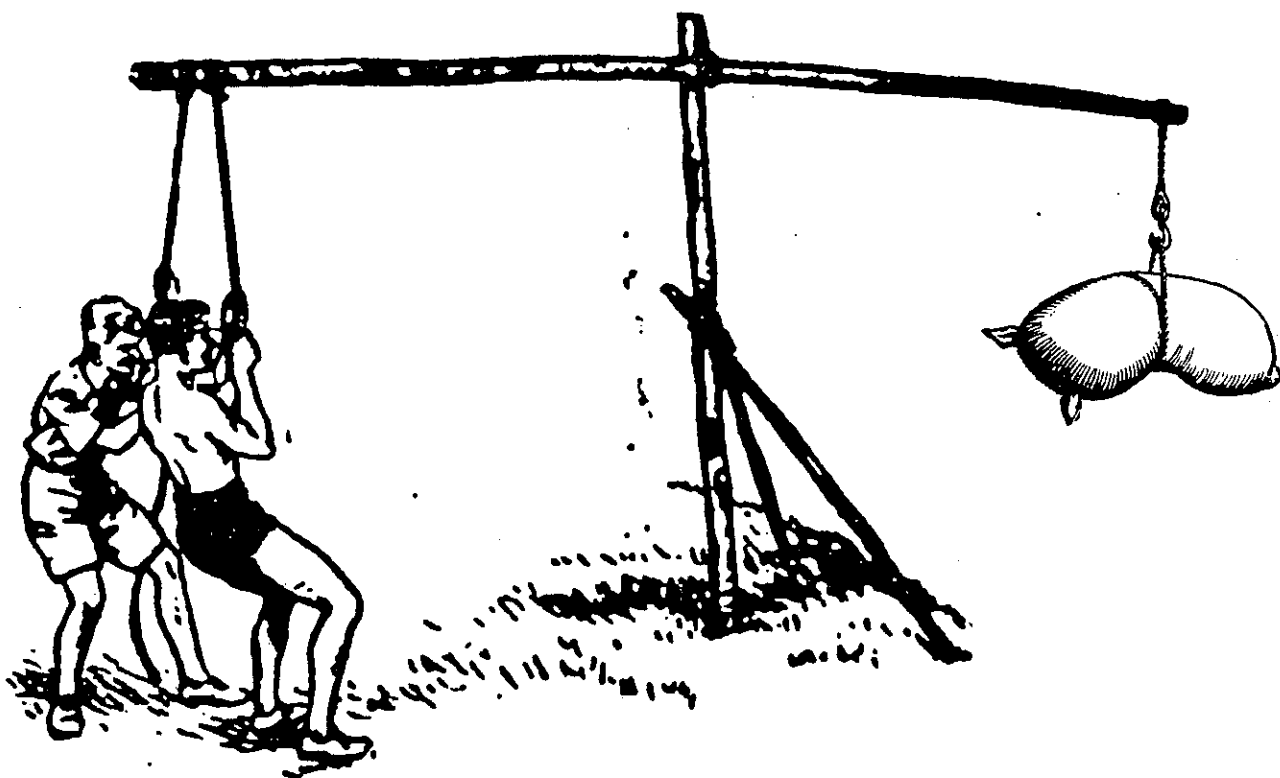

Figure 86 Using a Lever for Lifting

part of the lever extending between the fulcrum and the point at which the force is applied is known as the effort arm; that part which extends between the fulcrum and the point at which the resistance or load is placed, is called the resistance arm. Levers of the First Class all have the fulcrum between the effort and the resistance, such as a shears or pump handle. The mechanical advantage may be greater or less than 1, depending upon the location of the

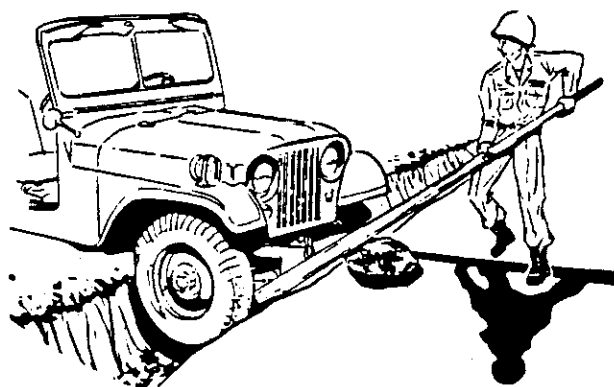

Figure 87 Simple Lever

fulcrum in relation to the effort and resistance. Levers of the Second Class have their resistance between the fulcrum and effort, such as in nutcrackers and wheelbarrows. The mechanical advantage is always greater than one because the effort arm is always longer than the resistance arm. Levers of the Third Class have their effort between the fulcrum and resistance, such as in shovels and hoes. The mechanical advantage of this type of lever is always less than one because the effort arm is shorter than the resistance arm. See Figures 86 and 87.

PARBUCKLE

The parbuckle, as shown in Figure 88-A, is used for moving, lifting or lowering logs or other objects which are roughly cylindrical in shape. The bight of a long rope is placed around an anchor such as a tree or stake. The ends of the rope are then passed under the load, around the back, over the top and are then brought back in the direction of the anchor. If both ends of the rope are then pulled or slackened together, the cylindrical mass can easily be raised or lowered. Of course, the pull must be kept even or the object will slip out of the parbuckle. If desired, a better grip can be taken on the cylinder if a round turn is used as in Figure 88-B. Parbuckles are used primarily for lifting or rolling. Hence they are either a "rolling" or "lifting" parbuckle.

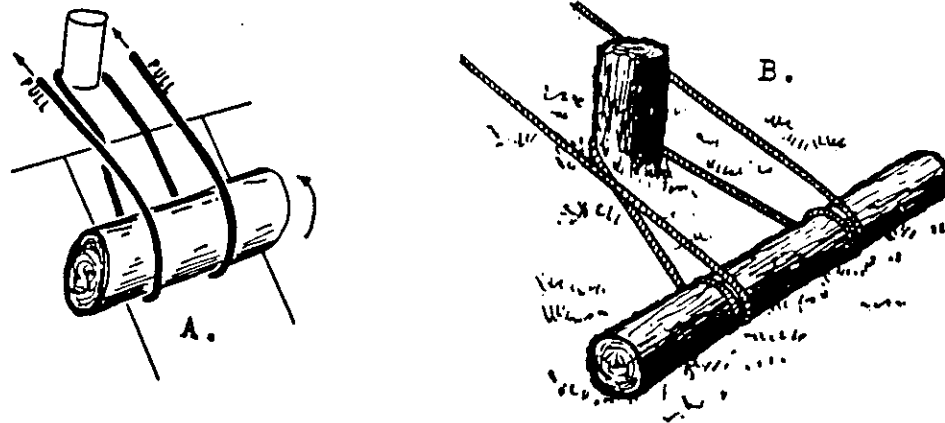

Figure 88 The Parbuckle

THE GIN POLE

Supposing you had two 18 foot vertical poles, one-third of which were buried in the ground, and let's say they were 15 feet apart. Now if you wanted to put a heavy crosspiece such as a heavy pipe or large log across

the top of the 12 foot vertical poles, an effective way to do it would be to use two gin poles, one on each vertical pole. This would consist of a smaller pole (the gin pole) about 15 or 16 feet long, which would be attached to the larger vertical uprights. The two gin poles would then extend 3 to 4 feet higher than the vertical poles. At the top of each gin pole would be a block and tackle arrangement in which the tackle would be long enough to attach to the cross-member, up, and reeved through the blocks, and the pull rope would have to reach to the ground. With this apparatus, it would be very easy to hoist the cross-member to the top of the large vertical standing poles. A gin pole can also be used as shown in Figure 89.

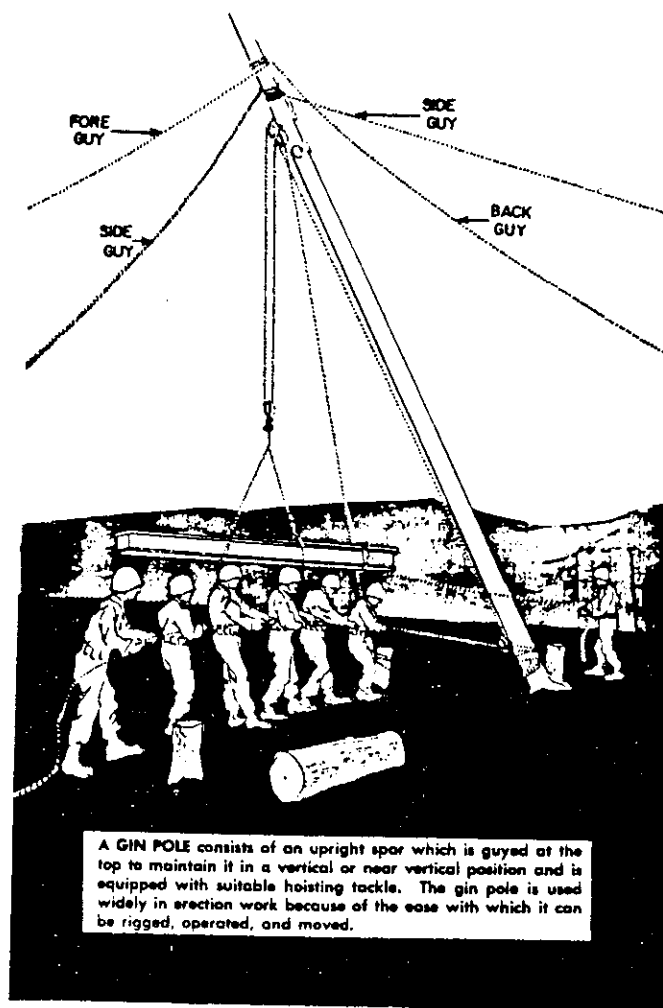

Figure 89 Hoisting With a Gin Pole

"A" FRAME vs. SHEAR LEGS

The primary difference between an "A" Frame and Shear Legs is that Shear Legs have a ledger or rope across the bottom of the legs, whereas in an "A" Frame the ledgers are not needed. See Figures 90 and 91.

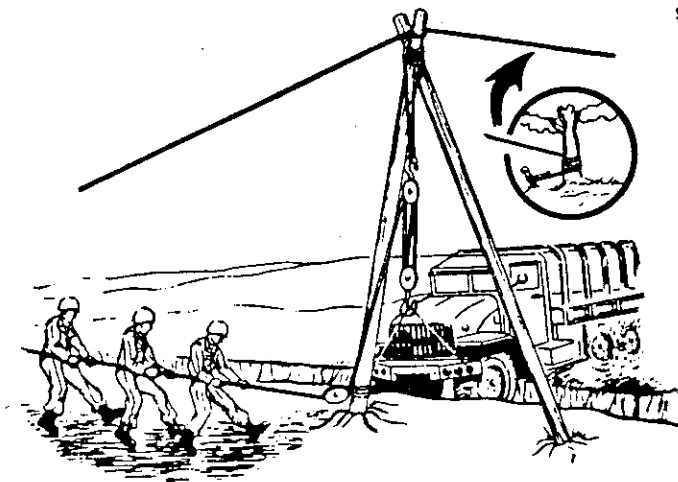
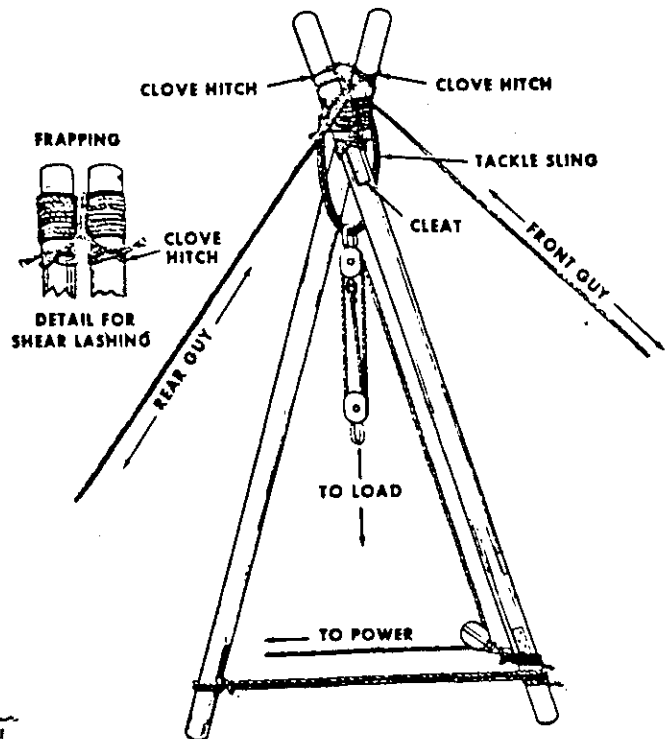

Figure 90 Use of an "A" Frame



SHEARS are easily assembled and require only two guys, and are adaptable to working at an inclination from the vertical. In addition to their hoisting and lifting capabilities, shears are used extensively as towers for cableways and in floating bridge operations.

Figure 91 Shear Legs

THE CABLEWAY

The Cableway is shown in Figure 92-A. These are fun to make for just riding, or the carriage may also be used as an equipment line for hauling. The carriage will have to have some sort of a pull back rope or a hauling rope may be added, which will allow the carriage to be hauled back and forth. Actually, if you want to make it simple, all you need is a pulley on each end of the span and a haul rope attached to each side of the carriage, as shown in Figure 92-B. See "The Cableway" on page 142.

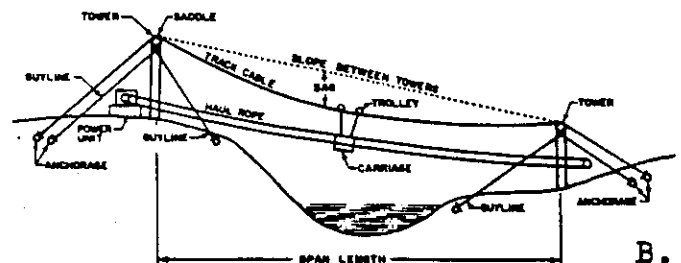
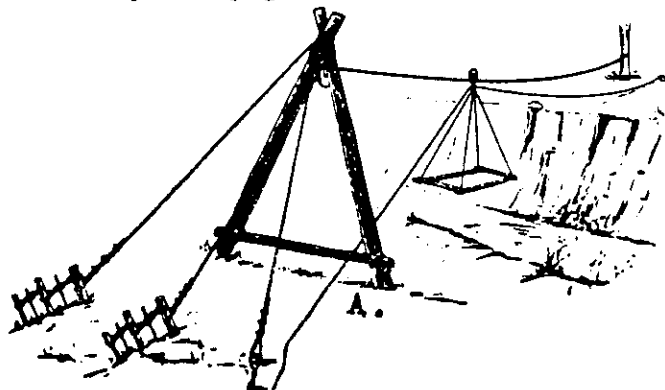

Nomenclature of components of a cableway system.

Figure 92 Cableway

TRIPODS

Tripods are very useful and can be used for a lot of different types of programs. A tripod is merely a three-legged apparatus with the three legs lashed together at the top with a Sailmaker's three pole lashing. It may or may not have crosspieces between the legs. See Figure 93.

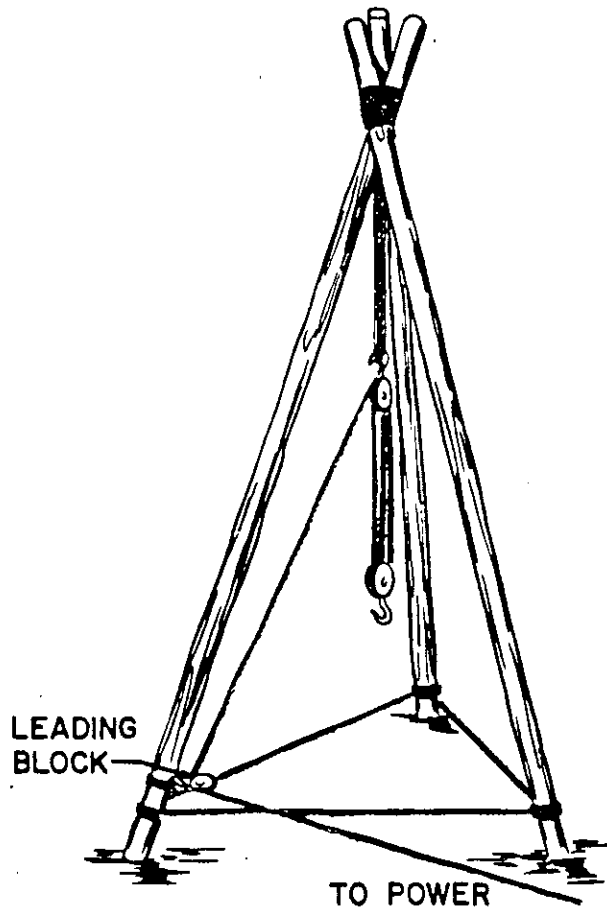

A **TRIPOD** consists of three legs lashed at the top. Its advantage over other devices is its stability. Its disadvantage is that the load can be moved only up and down.

Figure 93 A Tripod

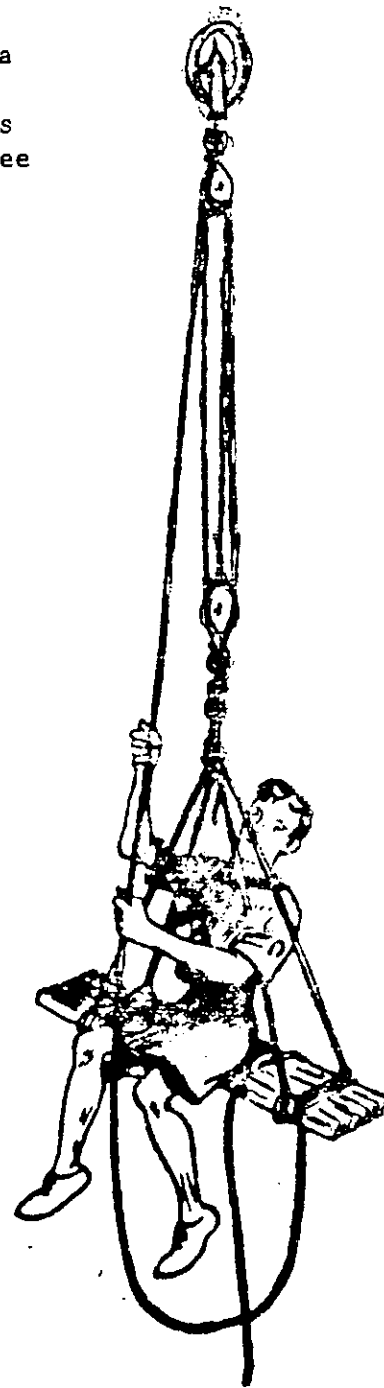

Figure 94 Self Lifting Hoist

THE SELF LIFTING HOIST

The Self Lifting Hoist enables one to lift his own weight alone. This is another block and tackle arrangement with a Bosun's Chair suspended from the lower block. With this apparatus, one can work comfortably above the ground. See Figure 94.

WINDLASS

A Windlass is a machine very similar to the wheel and axel, as seen in Figure 95. A windlass has a handle or crank, whereas the wheel and axel has only a wheel. A windlass is often used for lifting dirt out of a deep hole or in lifting heavy objects. It consists of a horizontal barrel for the hoisting rope supported in vertical standards and turned by crank with a handle. With a good windlass, you can pull many pounds. The mechanical advantage of a windlass is obtained by dividing the length of its handle by the radius of the drum upon which the rope is wound.

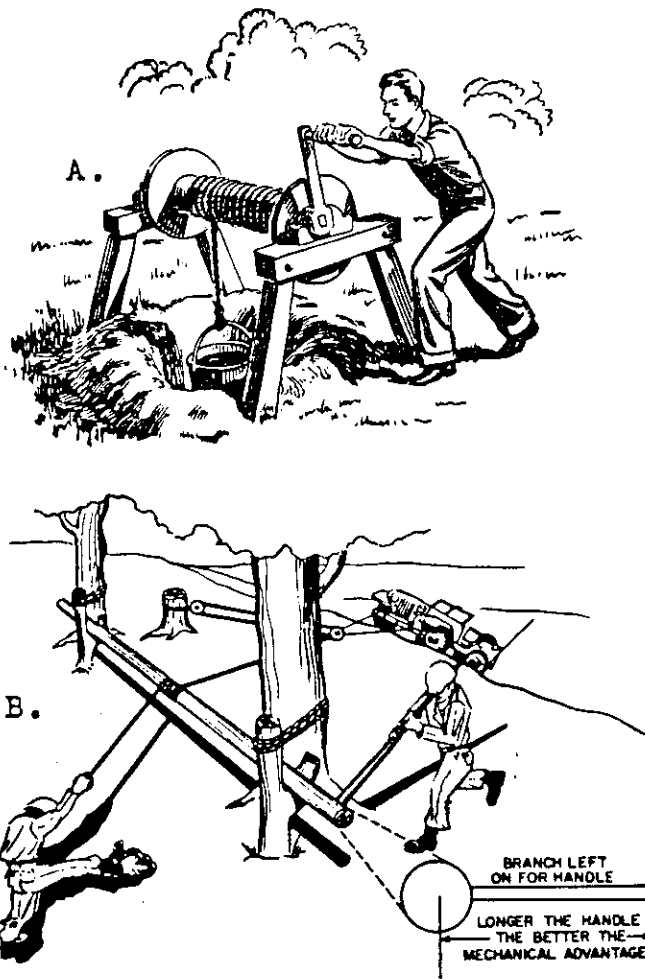

Figure 95 Windlass

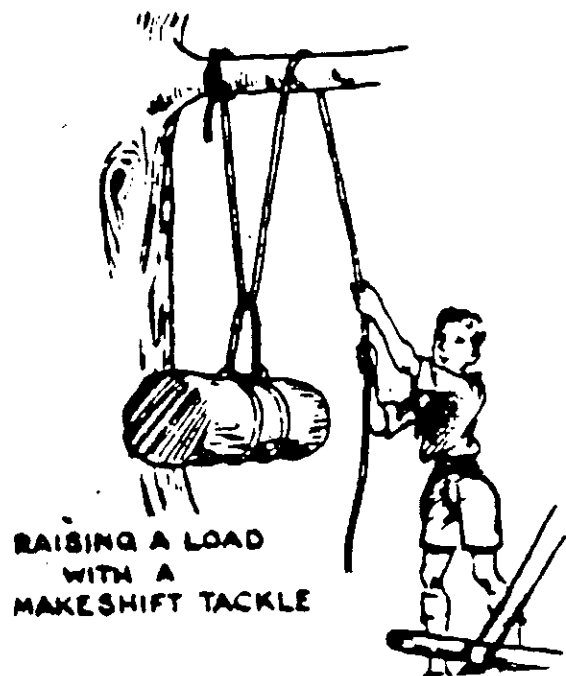

Figure 96 Makeshift Tackle

THE MAKESHIFT TACKLE

The makeshift tackle is an improvised block and tackle which will not give you a full 2-to-1 advantage because of the friction, but it will make tightening a line or lifting a load easier. See Figure 96. This is also called the Harvester's Hitch.

THE BOOM DERRICK

The Boom Derrick is another apparatus that can be built for work or pleasure. It is detailed in Figure 97.

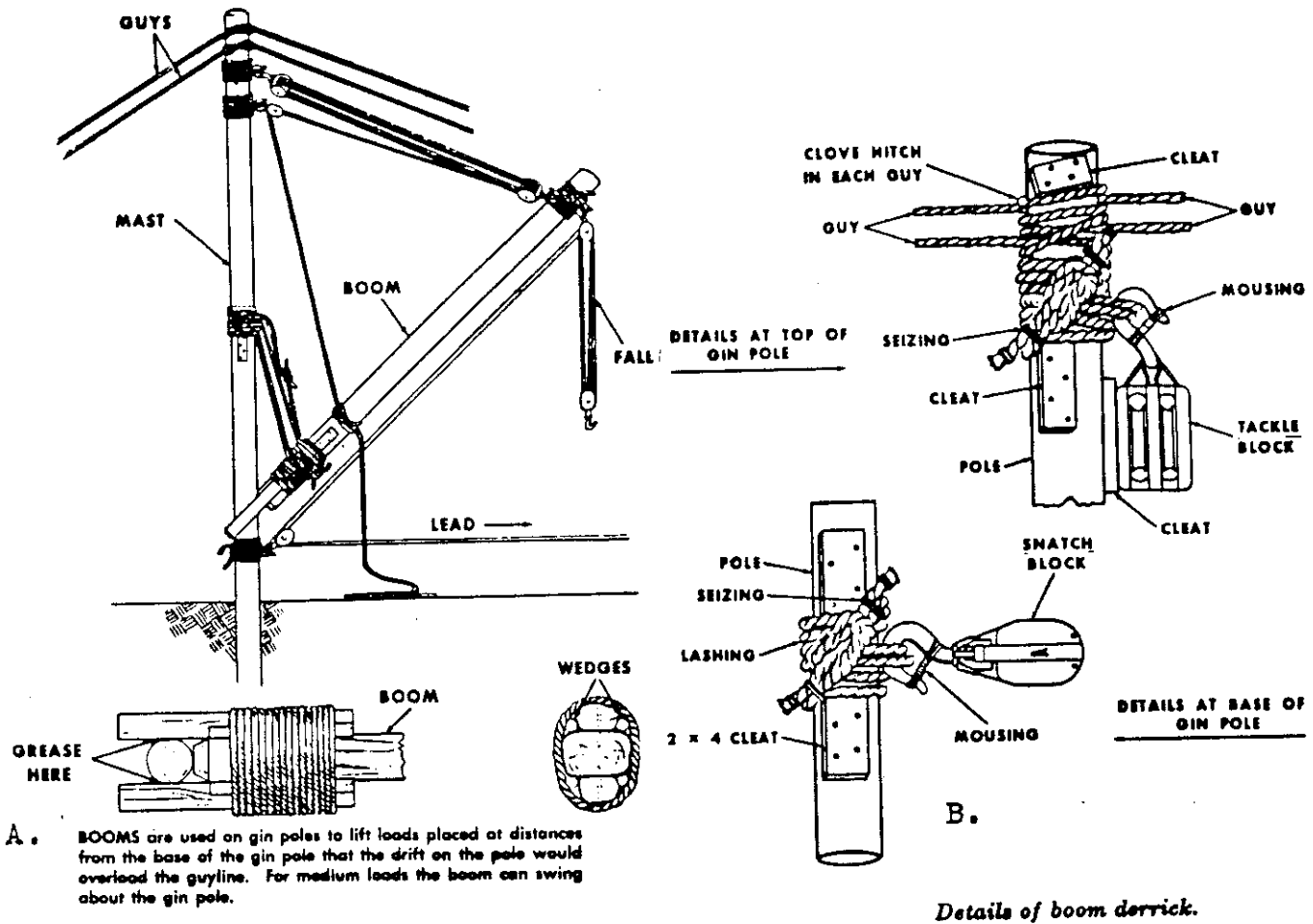

Figure 97 Boom Derrick

There are many more simple machines that can be made for work and fun. When one gets started building these things, the possibilities become unlimited.

CHAPTER 5

ROPE, CORDAGE AND KNOTS

One can have a lot of fun in the out-of-doors with rope. Ropes can be used for climbing, building various structures and for all types of program material.

TYPES OF ROPE

Rope can be divided into two general categories - plant fiber ropes and synthetic fiber ropes.

Plant fiber ropes include ropes made from jute, Asiatic hemp, Manila fiber, sisal and cotton. Synthetic ropes are man-made fibers, many of which are stronger and more durable than the plant fiber ropes. As time goes on, new ropes are being made in laboratories.

A. Plant Fiber Ropes:

1. Jute rope from the East Indian plant called *Corchorus olitorius* and *capsularis*. It is used for rope and cord. Jute rope is relatively uncommon in this country; however, jute string and cord are relatively common.
2. Asiatic hemp is rope made from the fibers of the Asiatic herb called *Cannabis sativa*. This rope is also rare in the United States.
3. Manila fiber rope comes from the Abaca plant, which is a member of the banana family chiefly found in the Philippines. This rope is commonly found as a three-stranded rope. When we refer to twisted rope in this book, it will usually be referring to Manila fiber rope. It is hard, pliant, and yellowish with a pearly luster. It may have dark or black fibers due to the fermenting of the plant leaves. When the rope is handled, it feels smooth and silky. The best grade of binder twine is made of Manila fibers.
4. Sisal rope is a strong, durable whitish fiber rope. Although it is not as strong or good as Manila fiber rope, it is acceptable rope for most usage. Most of it comes from Mexico and the West Indies from the Agave plants. The leaves of the Agave *sisalana* plant in Yucatan, Mexico, yield henequen, which is the sisal fibers used to make rope and a cheaper grade of binder twine. It is light yellowish to white, and it is stiff, hard, and feels rough and harsh to the hand.

5. Cotton rope is made from the Gossypium cotton plant and is used chiefly for string, sash cord and clothes line rope. It is soft, pliable and makes a good type of rope to learn knot tying.

B. Synthetic Fiber Ropes:

1. Nylon rope, which is one of the best synthetic ropes for general use, has tough elastic fibers with a high tensile or breaking strength with excellent resistance to deterioration.
2. Polypropylene is a good water rope because it floats and is easily dried out, and water does not harm it. It is not as strong as nylon, but it is relatively inexpensive. It is poor for learning to tie knots.
3. Polyester rope includes the trade names Dacron, Terylene and Fortrel. All of the polyester fibered ropes are almost as strong as nylon, and it loses little or no strength when wet. The elasticity is about half that of nylon and is quite resistant to deterioration. Polyester ropes are also poor for knot tying, but they are good water ropes.
4. Kevlar rope has a very high tensile strength. It is almost twice as strong as nylon with not much elasticity. However, it is abrasive and brittle and is especially poor for knot tying because if bent sharply the fibers cut one another, and this will, of course, weaken the rope.

There are other kinds of rope, both plant and synthetic, but the ones listed above are those which are most common and the ones which are on the market and in the hardware stores.

LAY OF ROPE

Most ropes are either woven, twisted (or laid) or braided. Most of the plant fiber ropes are twisted or laid, such as shown in Figure 98.

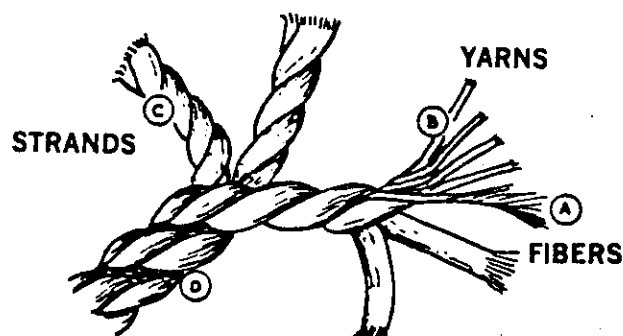

Figure 98 Twisted Rope

Individual fibers or threads are usually twisted together to the left to make a yarn. Two or more yarns are then twisted to the right to make a strand. Usually three strands are then twisted together to the left to make a right-handed lay rope. A three strand rope laid up to the right is called a hawser. If three hawser laid ropes are twisted together to the right, a three strand cable laid rope is formed having a left hand lay.

A right-handed-lay rope is laid up from the bottom left to the top right as shown in Figure 99-A. A left-handed-lay rope is laid up from the bottom right to the top left. See Figure 99-B.

A shroud-laid rope is a four stranded rope laid up to the right and may or may not have a core.

Most cotton ropes such as sash cord and clothes line are woven.

Most of the polyester and polypropylene ropes are braided. Those which are braided are either solid-braid, hollow-braid or tubular.

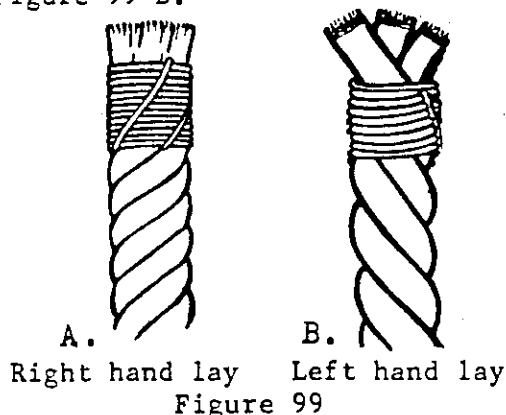

BREAKING STRENGTH OF ROPE

In the United States, most rope is usually bought and sold by its diameter. Figure 100 shows the approximate breaking strength for new ropes of different sizes and kinds without kinks or knots.

Approximate Breaking Strengths

Diameter (Inches)	Sisal	Manila	Polypropylene	Dacron	Nylon
1/4	480	600	1,050	1,600	1,800
3/8	1,080	1,350	2,200	3,300	4,000
1/2	2,120	2,650	3,800	5,500	7,100
3/4	4,320	5,400	8,100	11,000	14,200
1	7,200	9,000	14,000	18,500	24,600

Figure 100 Approximate Breaking Strength of Ropes

The safe working load for new rope is considered roughly at about 1/2 of the breaking strength. Breaking strength is the tension at which ropes fail when tested in the laboratory. As ropes get used and aged, the breaking strength and the safe working load reduces. Heavy jerking, dropping the load, knot tying and splices will all reduce the safe working load. Figure 101 shows the reduced strength of Manila rope with some of the common knots and hitches.

	Percent Efficiency
Full strength of dry rope	100
Eye splice over iron thimble	90
Short splice on rope	80
Timber hitch, round turn, half hitch	65
Bowline, slipknot, clove hitch	60
Square knot, weaver's knot, sheet bend	50
Flemish eye, overhand knot	45

Figure 101 Weakening Effects of Knots

CARE OF MANILA ROPE

In order to make rope last longer and do its job well, one has to give the rope a certain amount of good care. Some of the most important things to consider in the care of Manila rope are:

1. Coil when not in use in the direction of the lay.
2. Rope ends should be whipped or back spliced to prevent unraveling.
3. Avoid getting Manila rope wet when possible.
4. When it does get wet, it should be layed out in the shade. When wet ropes bake in the sun, the oils come out of the rope.
5. A rope should not be stepped on or dragged through the sand and dirt. Sand and dirt particles grind between the strands and will slowly cut the fibers.
6. Ropes should not come into contact with sharp corners or edges of rock.
7. Do not leave ropes knotted longer than necessary.
8. Prevent mildew on rope by storing in a clean dry place with circulation of air.
9. Periodically check the inside of heavy rope by twisting the strands apart to check for rotting.
10. Wash and dry muddy ropes.

COILING ROPE

Right-handed-lay ropes (hawsers and shroud) should be coiled clockwise. Left-handed-lay ropes should be coiled counterclockwise. One method of coiling a right-handed-lay rope is as follows:

1. Stretch the rope out on the ground.
2. Hold on to the end of the rope with the left hand, with the end folded back away from the body, to form a bight.
3. With the right hand, take an arm's length of rope and coil it into the left hand clockwise.
4. If there are kinks, twists or loops in the rope, shake them out or twist the rope with the thumb and forefinger to the right. This will make the loops uniform without kinks or twists.
5. When the rope is completely coiled, except for the remaining end, wrap the end around all of the coils tightly and then thread the end through the bight. Holding the end in position, pull the end of the bight trapping the other end into the wrap. See Figure 102.

THROWING A ROPE

When a rope has to be thrown, such as in throwing a ring buoy or throwing a rope across a creek, it will work better if you follow a few simple rules. For a right handed person, see Figure 103.

COILING A ROPE

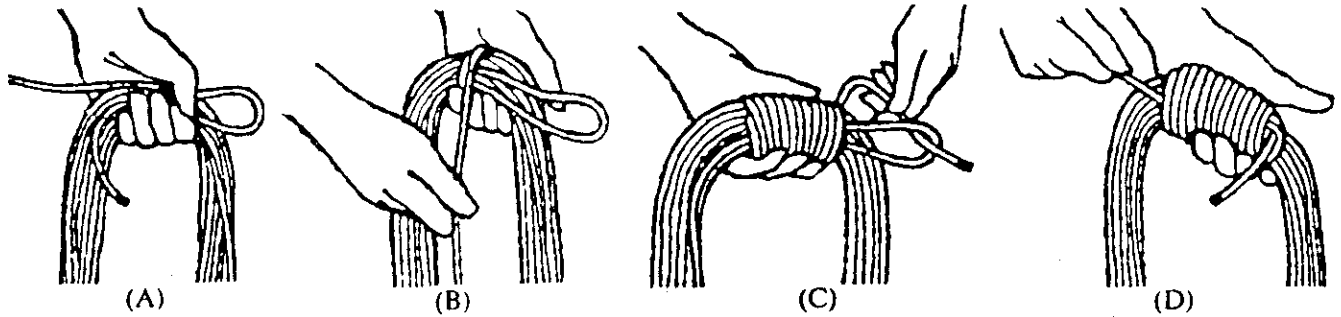

Coil the rope carefully so that it is not left in a "strained" state. Bad coiling induces kinks which weaken the rope and prove a nuisance.

Gather the loops freely into one hand while the other makes the coils. Do not coil the rope over the knee and foot. Coil "with the lay" so that kinks do not form. Practice will show which is the correct way. Lay each loop neatly on to the coil, so that loops do not tangle or cross, and are equal in size.

Use the ends of the rope to bind the coil firmly for carrying. Take the end of the rope where the coil started (A) and turn a few inches of it back along the coil. Grip the coil in one hand so that about a yard of the other end of the rope hangs free (B). Bind this free length tightly round the coil and the looped end until the free end can be tucked through the small loop (C). When the other end is pulled, the loop draws tight and holds the free end in place (D).

To uncoil the rope, pull the free end to loosen it. Undo the fastening turns and then, holding the coil in one hand, drop out the loops one by one on to the ground with the other hand. Let the loops fall naturally and loosely on to the ground. When drawing up the rope from the ground, pull the end at the top of the coil, not that from underneath. Never just drop a rope and pull one end or a tangle will result.

Figure 102 Rope Coiling

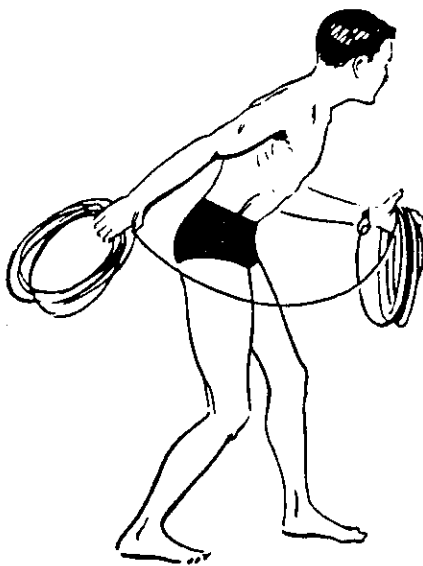

1. Throw the line beyond the target.
2. Retrieve and coil the line quickly so you will be ready for another throw if needed.
3. If you are right handed, throw with your left foot forward and right foot back.
4. If a rope is too heavy to coil into your left hand, coil it neatly on the ground. Then pick up the part of the coil you can hold comfortably in your right hand and throw it toward the target. Be sure to step on the shore end of the line or tie it down.

Figure 103 Rope Throwing

1. Coil the rope into the left hand.
2. Carefully take the coil into the right hand retaining the end of the rope and the first few coils which are nearest the base of the left hand.
3. The swing should be up and out.
4. A slight twist of the wrist, so that the palm of the hand comes up as the rope is thrown, will cause the coil to turn, loops to spread and the running end to fall free.

WHIPPING

There are many ways of whipping a twisted rope to make a good end on the rope and to keep the end from unraveling. One type of whipping is usually as good as another as long as the whipping is snug and smooth. Figure 104 shows five of the common forms of whipping rope ends. A good tough waxed string works very well for the whipping string.



A. Rope Tips

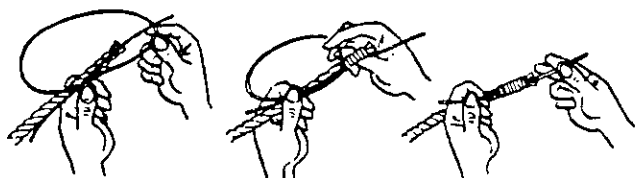

YOU WILL NEED ABOUT 2 FT. OF TWINE. MAKE A LOOP AND HOLD IT OVERLAPPING THE END OF THE ROPE WITH THE ENDS OF THE TWINE EXTENDING BEYOND THE LOOP AT BOTH SIDES.

PICK UP THE SIDE OF THE LOOP WHICH OVERLAPS THE END OF THE ROPE AND BIND TIGHTLY UNTIL YOU HAVE USED UP AS MUCH OF THE LOOP AS POSSIBLE. THEN PULL BOTH ENDS HARD TO TIGHTEN AND CUT OFF THE UNWANTED TAILS. THIS WHIPPING IS PARTICULARLY USEFUL ON THE ENDS OF BRAIDED THROWING LINES.

B. The American Plain Whipping

UNLAY THE END OF THE ROPE FOR ABOUT 2 INS. AND PUT A LOOP OF WHIPPING TWINE ROUND ONE STRAND

HOLD THE LOOP DOWN THE ROPE AND BIND TIGHTLY TOWARDS THE END

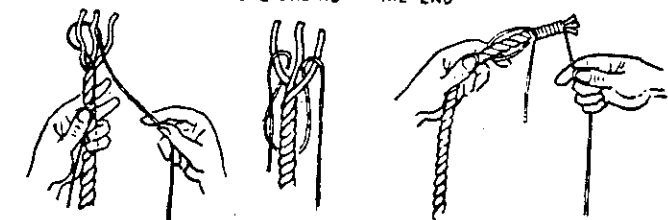

RAISE THE LOOP AND SLIP IT OVER THE TOP OF THE STRAND IT EMBRACES

PULL THE SHORT END TO TIGHTEN THE WHIPPING AND CARRY IT UP TO THE CROWN

C. The Sailmaker's Whipping

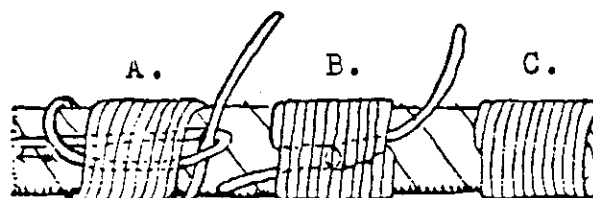

D. Seaman's Whipping

Whipping is a means of protecting the ends of ropes from fraying, by binding the fibres so tightly that they can't untwist. As whipping is done with carpet thread or sail twine it increases the diameter of the rope only a little. Before you start a whipping run the thread through shoemakers wax, soap or candle grease.

WEST COUNTRY

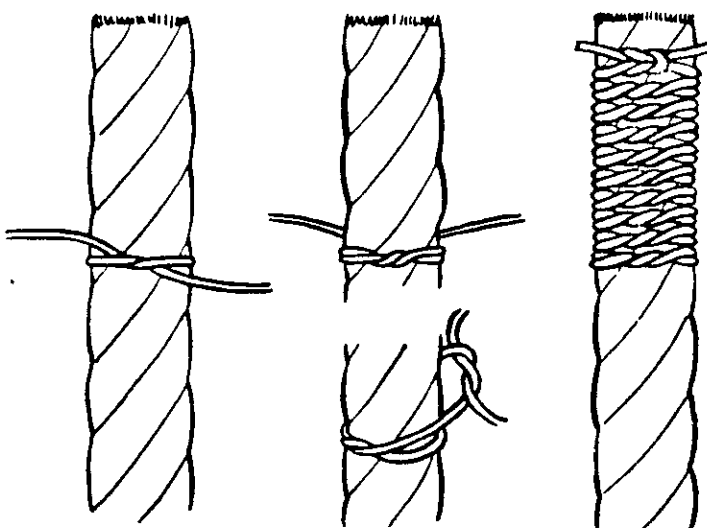

The simplest form of whipping. Tie thumb knot a few inches from the end of the rope. Tie thumb knot at back.

Continue to within 3" of the end. Finish off with reef knot. Trim end with sharp knife and rub with wax.

E. West Country Whipping

Figure 104 Rope Whippings

Another item which is available at sport stores is "whip-a-rope" rope tips. These are just small hollow rubberized tubes that have an adhesive coating inside of the tube. The piece of tubing is slipped over the end of the rope. The tubing is then heated all around with a match or lighter and this shrinks the tubing to the shape of the rope and activates the adhesive, forming a good durable tip for the rope ends. See Figure 104.

ROPE MAKING

Rope making is fun and easy. If you wish to understand rope just a little better, a good way to do it is to build yourself a simple rope making machine and make a piece of rope, keeping in mind that practice makes perfect. Like anything else, it takes a few tries before you can come up with a good looking piece of rope. The best thing to use is binder twine and a simple machine can be made as seen in Figures 105 to 107. Machines can be as simple or elaborate as you would like to make them. We have made ropes with the simpler methods and we have made ropes with elaborate machines consisting of good cranks and gears. The rope machines shown here are the very simplest, but as you make a rope making machine you will be able to improvise on it and make it much better than the ones shown in the figures.

TIN-CAN ROPEMAKER

Tie a loop in each end of a long piece of twine. Slip one stick into each loop. Triple the twine as shown in the diagram to make three strands. Place two soup or orange juice cans (with top and bottom cut out) as shown in the diagram. Each person holds a can in the left hand and turns the stick clockwise until the twine is wound up tight. Carefully triple the

twisted line so that there are three again. To do this, the cans may have to be removed and replaced after the line is tripled. This usually requires a third person to help.

Holding the can in the right hand, each person turns the stick counterclockwise until the line is wound tight. Then remove sticks and cans and whip the ends of the rope. This is a slow but effective process.

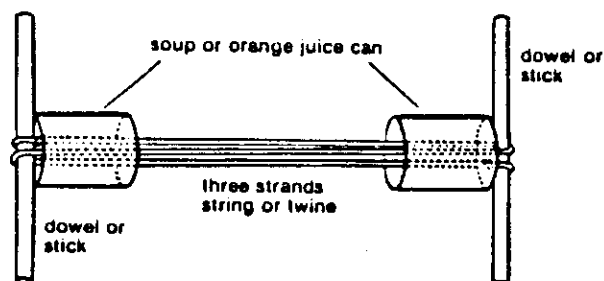
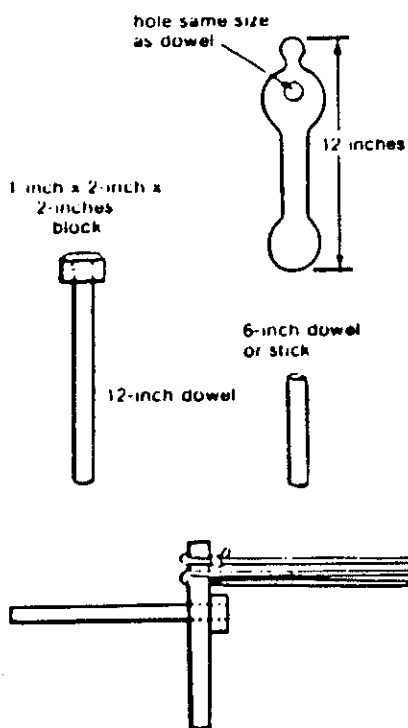
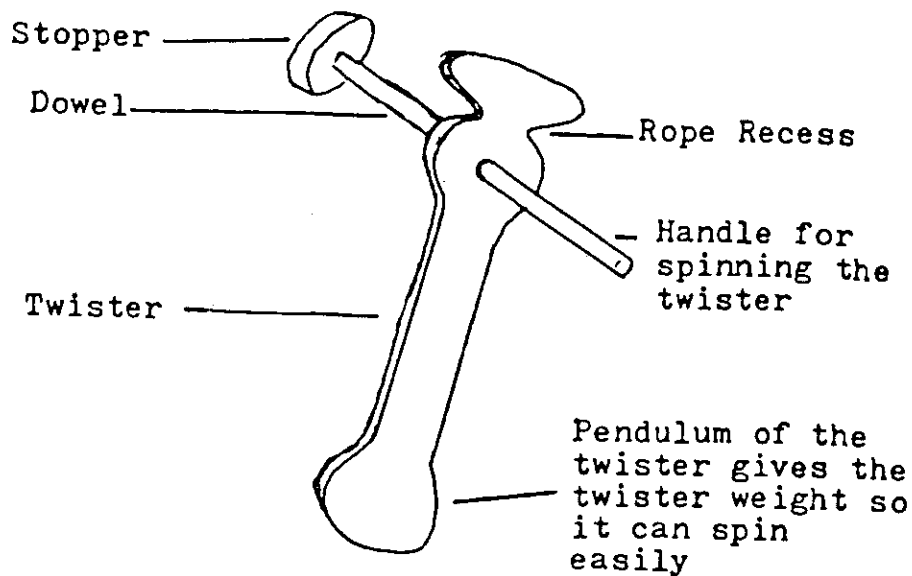

Figure 105 The Tin-Can Ropemaker



ROPE SPINNER

Tie a loop on each end of a long piece of binder twine or heavy cord. Attach the twine to the spinner as shown in the diagram so that you have three strands. Spin the spinner in a clockwise direction. When the twine is wound tight triple it again. A third person should do this so that the line can be held stretched out, otherwise it will kink badly. Spin the spinner counterclockwise until rope is wound tight. Take rope off the spinner, whip the ends, and it's ready to use.

Figure 106 The Rope Spinner

ROPE CRANK

Use half-inch wood for the parts. The hooks may be made of coat-hanger wire.

Use heavy string or twine. Tie the end of the twine to one of the hooks and loop it back and forth between the hooks and the awl. About three strands to each hook will make a medium-size rope.

Insert the crank handle in the cranks and start rotating it. Hold the strands apart with the rope wrench until they get fairly tight. Then take hold of the strands behind the wrench—that is, on the side away from the machine—and begin twisting them slowly together as the wrench is moved forward.

The rope will go into shape itself and remain there, but the wrench should be used to ensure even twisting and to prevent kinks. The cranks should be turned slowly while the rope is being formed.

When your rope is complete, take it off the hooks and whip the ends to prevent fraying.

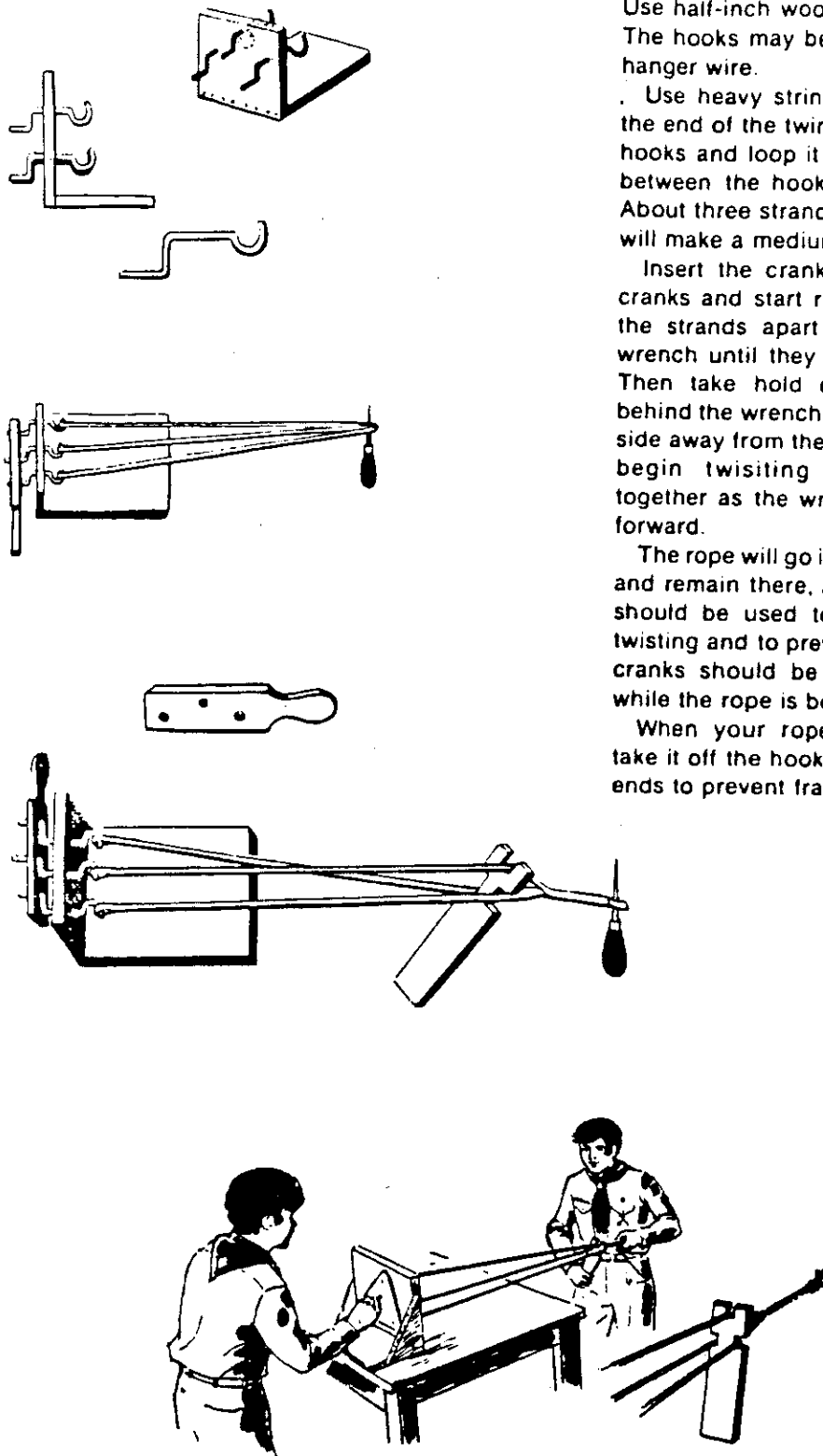

Figure 107 The Rope Crank

KNOTS

Knots are one of man's earliest inventions. There are literally thousands of knots. Over the centuries, knots have increased in numbers with the many different uses. They have been and are used by sailors, farmers, cowboys, explorers, mountain climbers, engineers, surgeons, builders, weavers, firemen, hobbyists and housewives. Today, mechanical fasteners and wire rope has reduced the importance of knots, but they are still and always will be very essential.

Many knots can be tied right or left handed, and when this is done, the knot may take on another name, such as the overhand knot and the underhand knot or the underhand and cowboy's bowline. Many knots are tied the same but are named differently due to the fact that different tradesmen have named them. As an example, the loop knot is also called the overhand loop or the middleman's knot. The cow hitch, the girth hitch and the larkshhead are all the same knot. Some knots can be upset to form another knot, such as the reef knot being upset to form a larkshhead on a cord, or the slip knot may be twisted around to form a marline spike hitch. Changing one little thing on a knot usually results in a different knot with a different name.

Many knots can be made "slippery" so they can be untied easily. Usually this consists of putting a bight in the last loop of the knot rather than putting the end through the loop.

Many knots can be made "secure" which will insure the knot's safety. As a general rule, a knot is made secure by the addition of a half hitch after the knot has been tied.

TOGGLES

Sometimes a knot must be locked temporarily as in the case of a larkshhead, sheepshank or harvester's hitch in order to make the knot more efficient. For this purpose, a small piece of wood, metal, or other inflexible material may be used. This is called a toggle. It may be inserted into a few specific knots and only a slight amount of stress is needed to hold the toggle in place. If the toggle is removed or withdrawn quickly, the knot will upset and release. This may be seen in Figure 159.

BASIC KNOT ELEMENTS

Learning to tie knots is the beginning of fun in rope work. Many knots may seem complicated, but even the most complex knots can be broken down into a combination of basic elements. First, in order to have a good knot, one should be able to tie it easily, untie it easily and it should do the job for which it was intended. In order to understand and describe knot tying, we must think of a rope as having two ends and a standing part. The working or free end of the end of the rope is the end

which is used when tying knots in the end of a rope. Most knots are tied starting with the working end; however, some knots are tied in the standing part, which is between the ends.

As a forerunner to knots, one must know the basic knot elements. They are the free end, the standing part, the bight, the overhand and the underhand loop. An overhand loop is made by placing a loop which has been formed by the right hand over the standing part, which is held in the left hand. An underhand loop is formed by picking up the rope with the palms down, making a loop with the right hand, and placing it under the part in the left.

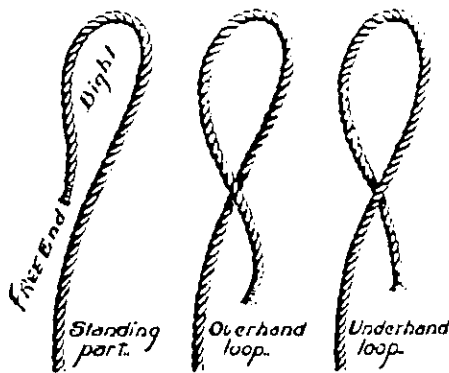

A bight is formed by laying any part of a rope along side of or parallel to any other part of the rope.

The free end is the working end. See Figure 108.

Figure 108 Basic Knot Elements

CLASSIFICATION OF KNOTS

Knots may be grouped in many different ways. There are bends, hitches, decorative, stopper, lanyard, single, double, single or double loops, running loops, fancy knots, trick knots, shortenings, end knots, climbing knots, rescue knots and the list could go on and on. Again, for the purpose of this book, we will divide the knots into seven categories:

1. End knots are used for temporary whipping and to keep the end of a rope from going through a block or other opening. It is a stopper knot.
2. Hitches and ties are used to secure a temporary line to an object.
3. Bends are joining knots. They are used to tie ropes together.
4. Anchor knots are knots which form permanent anchorage on one end of the rope. The rope can then be tightened or intermittently jerked and the knot will hold fast.
5. Running loops are knots in which the standing part may be drawn easily through a loop, such as a lasso.
6. Fixed loops are knots that form a loop which will not slip. They may be tied in the end of the rope or in the standing part.
7. Specialty knots are those which will aid us in special activities.

The following 60 knots will be a key factor in many of the programs in this book.

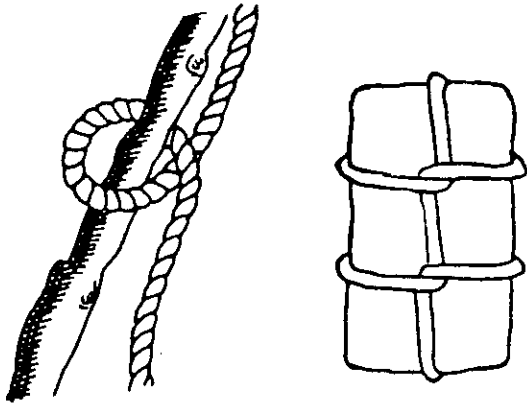

Figure 109 The Simple Hitch

The Simple Hitch (Single Hitch or Marline Hitch) is formed by passing the rope around an object and partly secure or hitch it by placing the free end over the standing part.

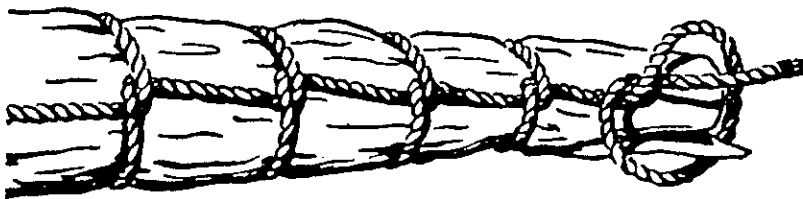

Figure 110 Marling

Marling is a series of simple hitches used to fasten a long object or package. The sections which run the long way should always emerge on the underside of the rope crossing.

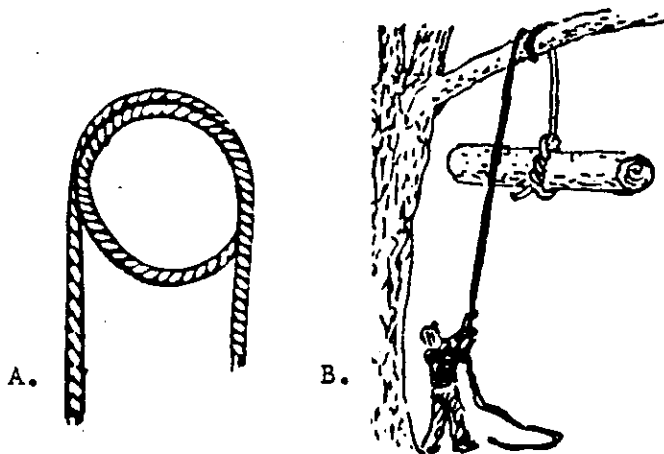

Figure 111 The Round Turn

The one, two or three rope Round Turns around a smooth tree or pole can be very useful in raising a heavy load as in Figure 111-B. The round turn prevents slippage while the tie off knot is being made. If lifting a heavy weight, the round turn is very effective to hold the weight if one person holds the end of the rope and takes in the slack. This relieves the lifters from having to hang on to the weight at all times.

END KNOTS

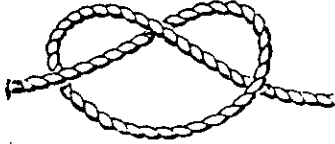
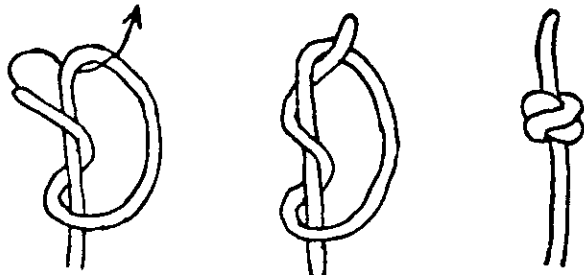

Figure 112 The Overhand Knot



Figure 113 The Underhand Knot



The Blood Knot or
Figure 114 Double Overhand Knot

In tying an Overhand Knot, make an overhand loop and bring the end from the bottom up through the top. It is useful in tying end knots in thread or string. It is also used to prevent a rope end from going through a block or other opening. It also may be used as a temporary whipping for three strand rope.

Technically, the overhand and the Underhand Knot are tied differently. In an underhand knot, make an underhand loop and put the end through the loop from top down. However, most authorities use the overhand/underhand knot interchangeably.

The Double Overhand Knot or Blood Knot is also used as a stopper knot. Back in the days of the pirates the blood knot was tied near the ends of a whip to help draw blood, thus the name "blood knot." It may also be tied as a 3 - 6 fold overhand knot.



Figure 115 The Figure 8 Knot

The Figure 8 Knot is used the same as the overhand knot, that is, as a stopper knot, to prevent unraveling of three strand rope and as a knot in preventing a rope from going through a pulley or block. It is untied much easier and causes less strain on rope fibers.

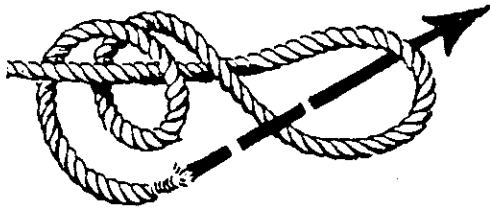

Figure 116 The Stevedore Knot

The Stevedore Knot is a simple variation of the figure 8 knot. It is made by carrying the end around the standing part twice before passing it through the loop. It has the same uses as the Figure 8 knot.

HITCHES AND TIES

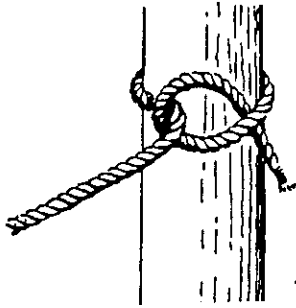

Figure 117 The Half Hitch

The Half Hitch is tied with one end of the rope which is passed around an object or rope and then secured to its own standing part with a simple hitch. If the object around which a half hitch has been made is withdrawn, an overhand knot remains. The difference is in the application of the knot. The half hitch is also used to secure many knots, such as the reef and bowline.

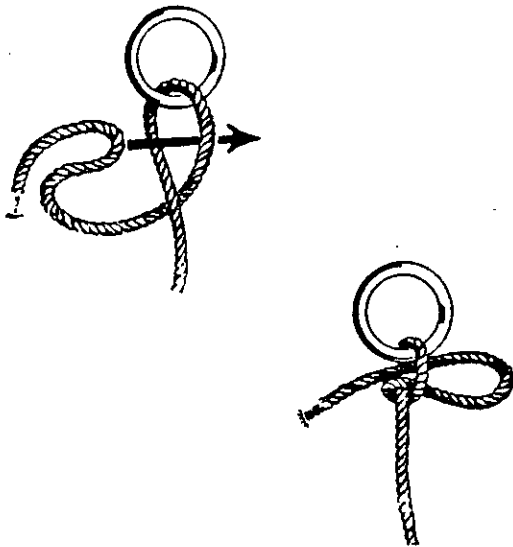

Figure 118 The Slippery Half Hitch

The Slippery Half Hitch may be used as a temporary anchor knot where the strain will be steady. This knot could be used as a rescue knot. If you were on the third floor of a burning building and had one large rope and one piece of strong cord that would reach only one floor, you could tie a slippery hitch to an object and slide down the rope to the next floor. By attaching the cord to the end of the hitch, you could retrieve the rope by pulling on the cord. This would upset the knot and free the rope. In this manner you could descend to the ground. You may have to break some windows in order to get on the under floors, but this would be feasible.

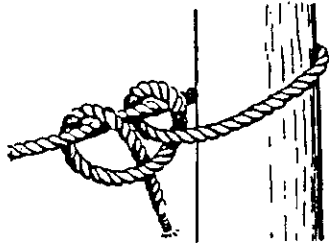

Figure 119 Two Half Hitches

Perhaps one of the best uses for the Two Half Hitches is simply securing a rope to an object. In tying two half hitches be sure both loops are either overhand or underhand. If not, you will end up with a larkshead.

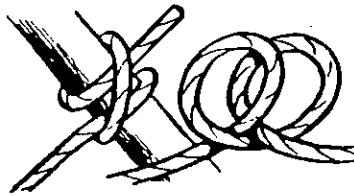

Figure 120 The Clove Hitch

The Clove Hitch slips fairly easy unless it is secured. It is used to start and end several lashings. The only difference between a clove hitch and two half hitches is that a clove hitch is tied around an object whereas two half hitches are tied around its own standing part.

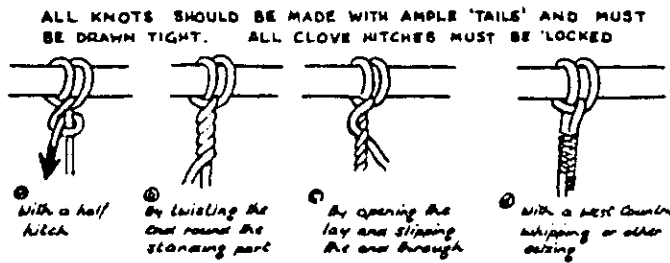

Figure 121 Securing the Clove Hitch

A clove hitch is good for a temporary hold for steady strain - not intermittent. If the strain is going to be intermittent, the knot must be secured. The drawings in Figure 121 show several ways that a clove hitch may be secured.

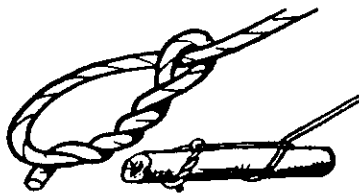

Figure 122 The Timber Hitch

The Timber Hitch is excellent for lifting and towing logs and other heavy strains. It is very easily tied and untied. When towing a longer object, such as a log, a simple hitch may be added near the end of the log nearest the power for the purpose of guidance.

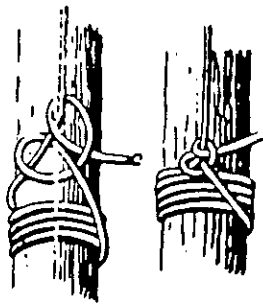

Figure 123 The Pipe Hitch

The Pipe Hitch is one of the best knots to use for lifting a pipe vertically. It is easy to tie and if the knot is snugged up it will hold most any pipe.

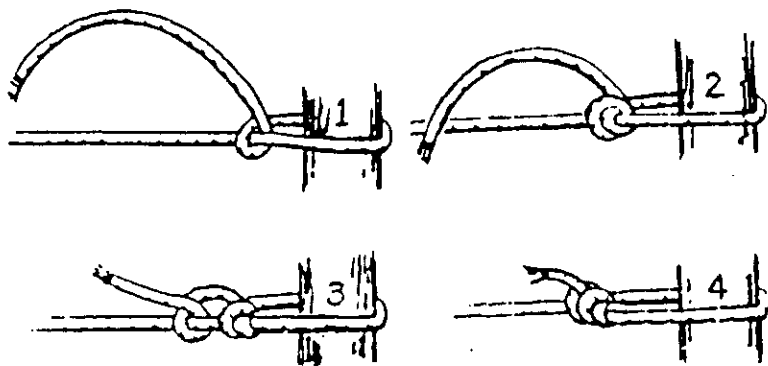

Figure 124 The Tautline Hitch

The Tautline Hitch is a good knot for tightening guy ropes on tents, etc. It can be slipped up and down on its own standing part, but it will hold under strain.



GUY-LINE HITCH can be lengthened or shortened as needed.

Figure 124-A clearly illustrates the guy-line hitch which is used for the same purpose as the tautline hitch.

Figure 124-A Guy-line Hitch

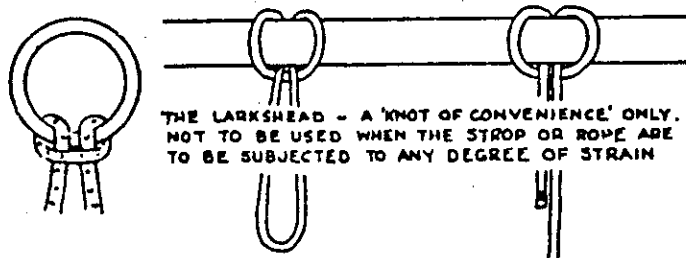

THE LARKSHEAD - A 'KNOT OF CONVENIENCE' ONLY. NOT TO BE USED WHEN THE STROP OR ROPE ARE TO BE SUBJECTED TO ANY DEGREE OF STRAIN

The Girth Hitch or The Larkshhead

Figure 125

The Girth Hitch or Larkshhead is used chiefly in tying the cinch strap of a western saddle. When it is tied in the middle of a rope with a toggle, it is called a larkshhead. It is often used in attaching tags to luggage.

BENDS (JOINING KNOTS)

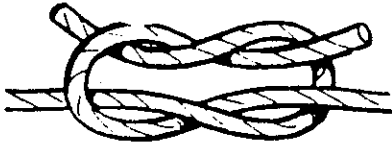

The Reef Knot
Figure 126 or Square Knot

The Reef Knot or Square Knot is a popular knot used in tying thread together, string together, and for tying up bundles. It is not good for heavy rope work or for tying large ropes together because it can upset into a larkshead.

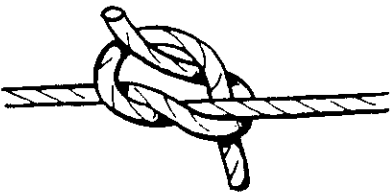

Lubber's Knot or
Figure 127 The Granny Knot

Whenever the reef knot is shown, it is usually followed by the Granny Knot or Lubber's Knot, which is a very poor knot and if the reef knot is not tied properly, a granny knot may result. It is shown here so as not to be confused with the square knot.



Figure 128 The Thief Knot

The Thief Knot is another poor knot which can be mistaken for the reef knot. When tying a reef knot the ends must be on the same side of the knot. If one end is on one side of the knot and the other end is on the other side of the knot, a thief knot results, and this is a very poor knot. It is said sailors sometimes tied this knot in their duffel bags and if thieves tampered with the bag, they would retie a square knot.

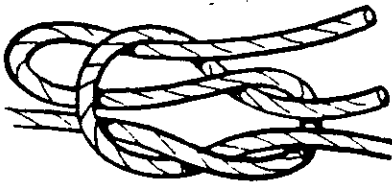

Figure 129 The Slippery Reef Knot

The Slippery Reef Knot is a regular reef knot where the bight is put through the loop instead of one of the ends. By pulling the end on the bight, the knot will upset easily. This knot is a good temporary knot, if the knot is going to get wet or would be under heavy strain, because it can be easily untied.

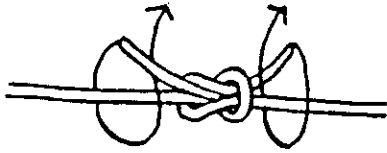
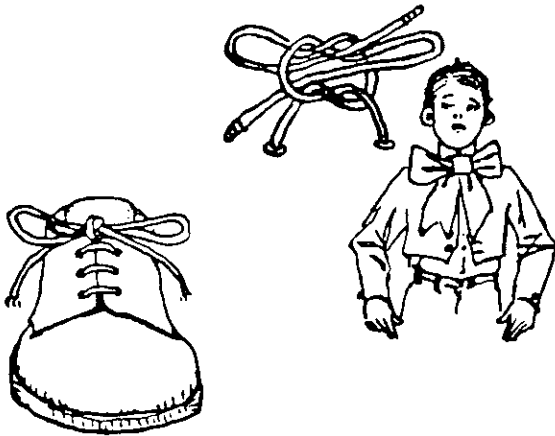

Figure 130 The Secured Square Knot

To prevent the upset of the square knot into a larks-head, tie a half hitch around the standing part on either side of the knot. This is called a Secured Square Knot.



The Square Bow Knot
Figure 131 or Shoestring Knot

The Square Bow Knot or Shoestring Knot is tied like the square knot except the bight is placed through the loop instead of the end. The bows will lay parallel to the standing part. If a granny bow knot is tied the bows will be perpendicular to the standing part. This knot is used in hair bows, package bows and as a shoestring tie. The true bow knot will hold much better than a granny bow knot.



Figure 132 The Surgeon's Knot

In the Surgeon's Knot, because of the extra loop on the first overhand knot, the knot will hold better while you tie the second overhand.



Figure 133 Two Bowlines

Another good joining knot is to tie Two Bowlines with the loops interlocked. This would be one method of tying two big ropes together. The method of tying the bowline is shown in Figure 138.

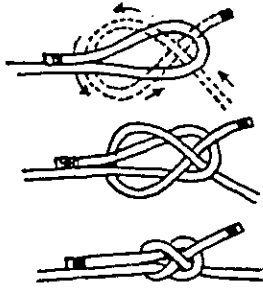

Figure 134 The Sheet Bend

One of the best knots to use to tie two ropes of the same size together is a Sheet Bend. If the knot is going to get wet, insert a stick into the knot. This will facilitate untying. Notice that the ends of the knot are both on the same side of the knot.

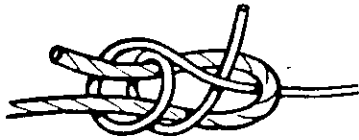

Figure 135 The Double Sheet Bend

The Double Sheet Bend is best used as a joining knot for ropes of unequal sizes. An extra wrap around the end and standing part makes the knot hold more securely. Always make the bight with the larger rope, and weave the smaller rope around it.

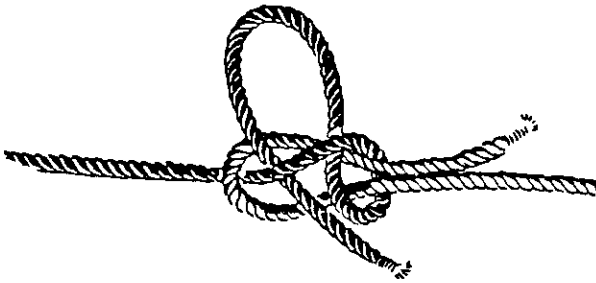

Figure 136 The Slippery Sheet Bend

Again, if a rope is going to get wet or be under heavy strain, the knot may be tied Slippery by putting a bight through rather than the end. This facilitates untying the knot.

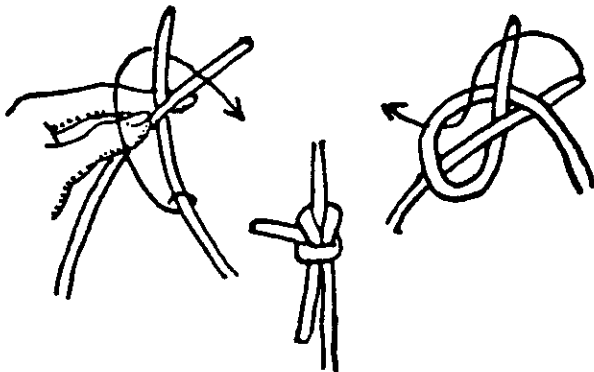

Figure 137 The Weaver's Knot

The Weaver's Knot is almost identical to the sheet bend. It is used chiefly by seamstresses and weavers. The knot differs in the way it is tied and in the fact that the one cord goes over and down through the bight, rather than coming up through the bight as in the sheet bend.

ANCHOR KNOTS



Figure 138 The Sailor's Bowline

When working with heavier ropes such as with lines across creeks or stretching lines between trees or making rope runways, one of the best knots to use to anchor the rope is with a Sailor's Bowline.

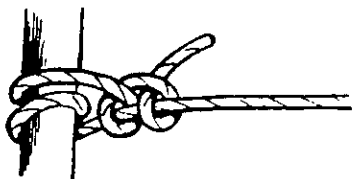

Figure 139 The Round Turn and Two Half Hitches

When working with ropes, another good anchor knot is the Round Turn and Two Half Hitches. This also makes a good tie-off knot on the other end of the anchor rope.

ROPE SHORTENINGS

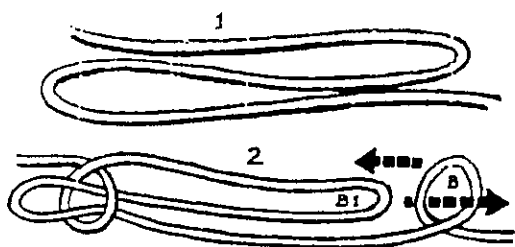

Figure 140 The Sheepshank

A Sheepshank is a knot used for shortening a rope without cutting it. It can also be used as a knot to take the load off a weak spot in the rope. Still another use for the sheepshank is to use it as a man-sling by jamming the two hitches together, which will result in two adjustable loops. See Figure 163 on Page 90.

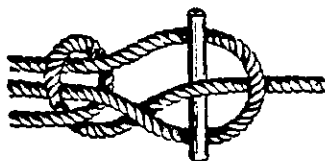

Figure 141 Sheepshank Secured

If you want to make a sheepshank so it will definitely hold, you must use a toggle attached as in Figure 141 through each loop on the ends of the sheepshank.

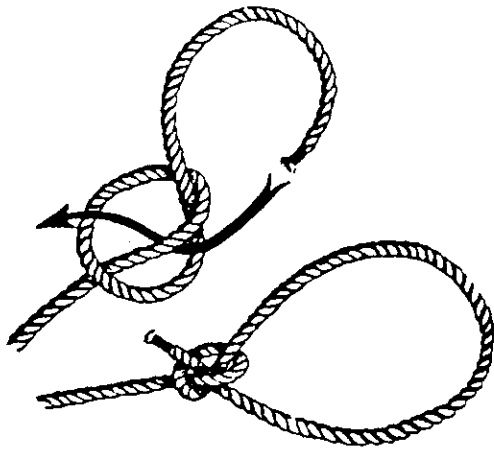

Figure 142 The Lariat Loop

When the Lariat is tied correctly, it makes a small round eye in which the end may be placed through, making a running loop. This may be used as a lasso. The knot must be drawn up snugly and sometimes an overhand knot is put into the working end, so it doesn't slip out of the hand.

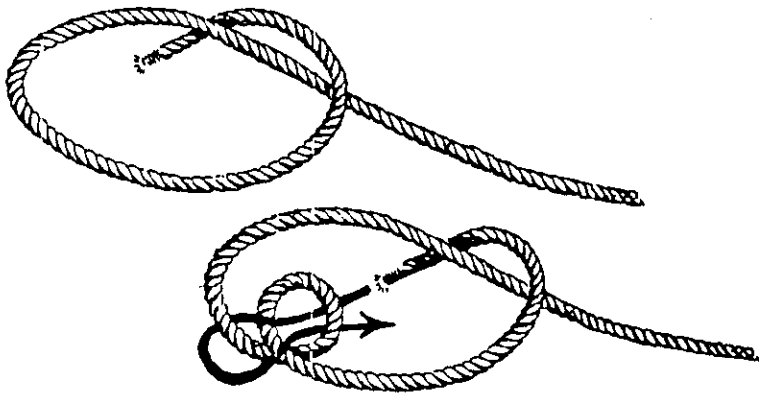

Figure 143 The Running Bowline

The Running Bowline makes a good slip knot. Tie the knot around the standing part and keeping the loop rather small, snug up the knot tightly. For making a running noose, this knot is superior to the other two.

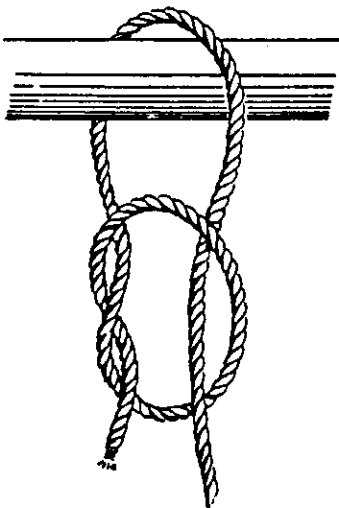

Figure 144 The Slip Knot

The Slip Knot is neither strong nor secure. It is a good knot to use to help bind up parcels, etc., but it is relatively a poor knot for the most part. It is usually advisable to put an overhand knot in the free end when it is used on heavy bundles.

FIXED LOOPS



Figure 145 Loop Knot or Overhand Loop

The Overhand Loop is also called the Loop Knot or the Middleman's Knot. It is nothing more than an overhand loop on a bight. This makes a good solid knot but it is difficult to untie unless a toggle is used within the knot.



Figure 146 Figure-of-Eight Loop Knot

Figure 146 shows the Figure-of-Eight Loop Knot which is easier to untie. This knot is also called the Figure-of-Eight-on-a-Bight.

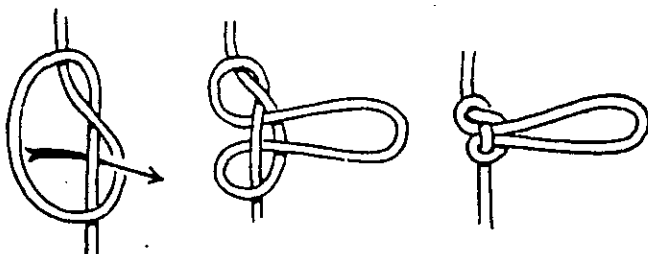

Figure 147 The Man Harness Knot

The Man Harness Knot is tied in the middle of a rope. If several people wanted to pull together on the same rope, a series of man harness knots could be used effectively. In this way each person could pull with a loop rather than just on a straight rope.

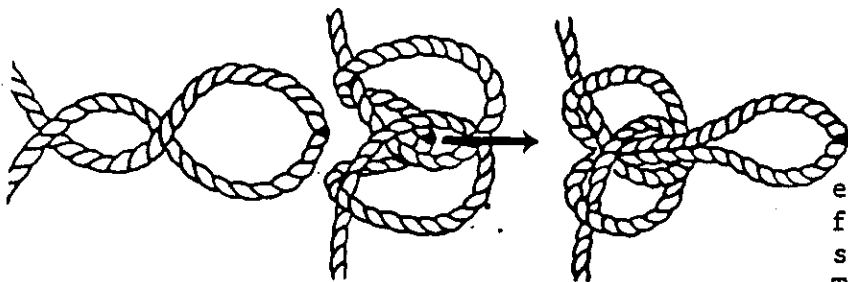

Figure 148 The Butterfly Knot

The Butterfly Knot is an excellent knot to use if a fixed loop is needed in the standing part of the rope. This knot can also be used to take up the slack in the standing part of a rope. It is tied and untied easily.

The Double Butterfly is another excellent knot to be used if you need two loops. The loops can be made the same size or one can be considerably larger than the other. This knot is excellent to help make the "double butterfly-prusik tightening arrangement." To make loops of different sizes, adjust the third loop.

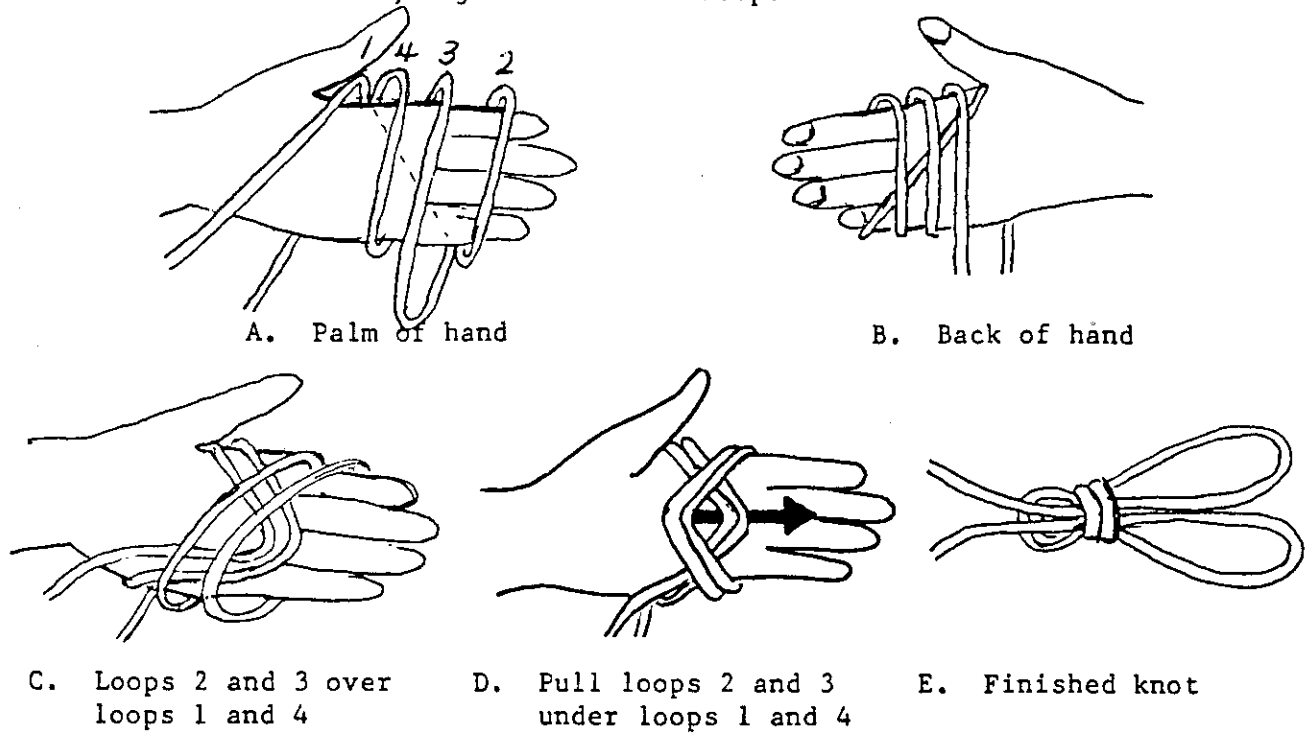

Figure 149 The Double Butterfly

The Bowline is one of the best knots. It has many variations and has a myraid of uses. It is often called the "king of knots." It makes an excellent anchor knot; it forms a good non-slip noose; it makes a good running noose; it can be used to join two ropes together; it is used as a climbing knot and as a rescue knot.

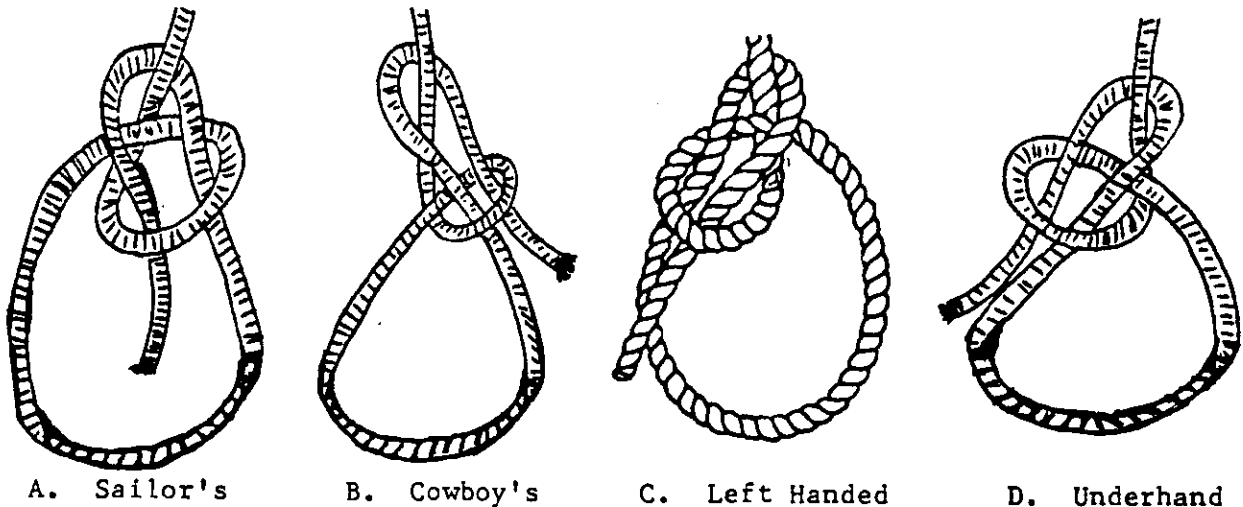

Figure 150 The Bowline

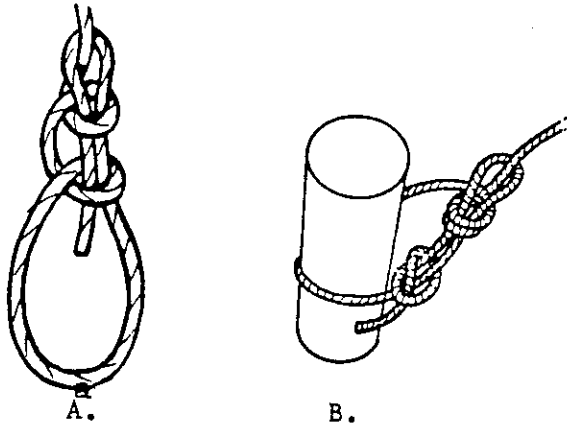

Figure 151 The Water Bowline

A Water Bowline should be used if a bowline knot has to get wet. The knot will be much easier to untie and it will hold more securely while it is doing its job. Figure 151-B shows the water bowline secured with a half hitch. This knot is sometimes called a double-loop bowline.

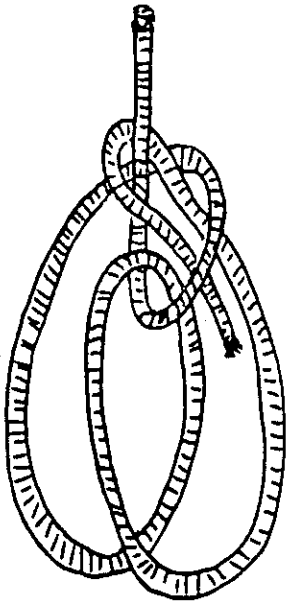

Figure 152 The French Bowline

The French Bowline is used to form two adjustable loops. This knot may be used as a chair knot with one loop around the knees and the other loop around the back under the arms.

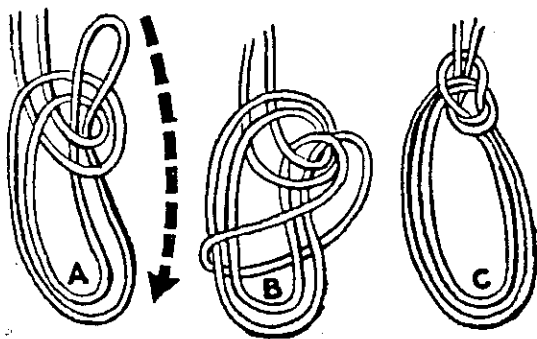

Figure 153 The Bowline on a Bight

The Bowline on a Bight forms two fixed loops which cannot be adjusted. This knot has also been termed the Man-sling because it makes a good knot to use when lowering a person from a height.



Figure 154 The Running Bowline

The Running Bowline has already been discussed in Figure 143. When a running noose is needed, this knot is decidedly superior to the slip knot and lariat loop.

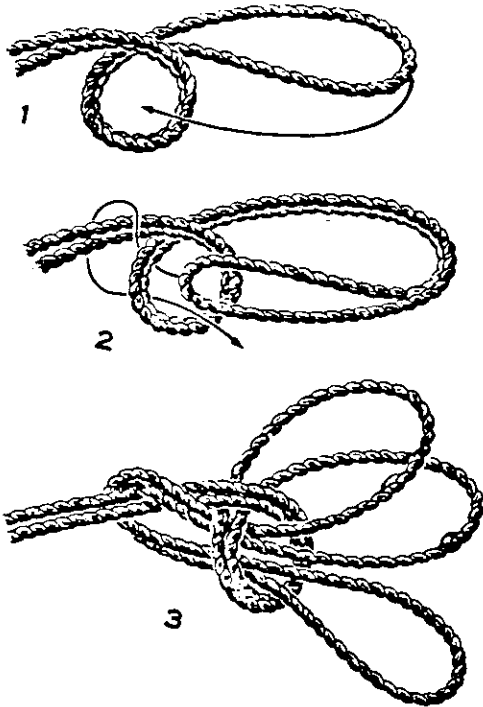

Figure 155 The Three Loop Bowline

The Three Loop Bowline, of course, forms three fixed loops which will not slip, two of which may be adjusted against the third. It can be used as a junction knot for multiple lifting points. It may also be used as a sling by putting one loop around the back and the other two loops used for the legs.

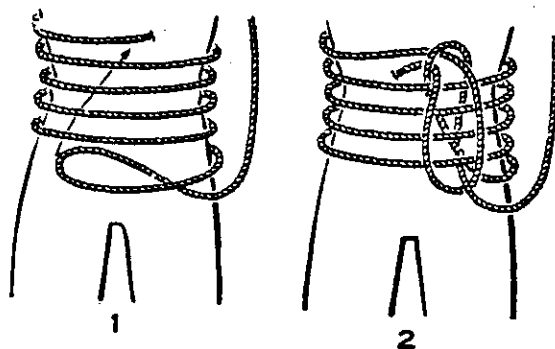
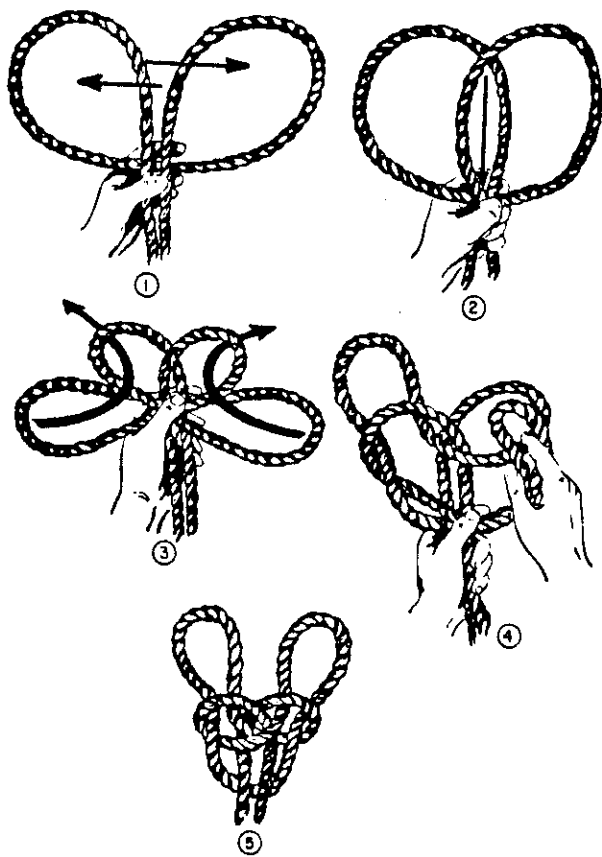

Figure 156 Bowline on a Coil

The Bowline on a Coil is often used by the end man in a climbing party to take up the slack in the rope or it can be used as another method of securing a coil of rope.



A. Spanish bowline



B. The Spanish bowline used to lower an unconscious person

The Spanish Bowline is another form of a bowline which when tied gives two fixed loops. This is an excellent knot to use to make leg loops for a traverse crossing. It also makes a good rescue knot for lowering someone from a tree, cliff, etc. All one has to do is place each leg in one of the leg loops of the knot and hold on to the standing part of the rope while being lowered by another person.

This knot may also be used to lower an injured or unconscious person by placing one leg through each of the loops. If unconscious, after the loops are well around the tops of the legs a simple hitch can be put around the chest under the armpits and the person is then safe for lowering. See Figure 157-B. In the event an unconscious person would have to be lowered in this manner, it would probably be necessary to work fast so you could get the victim down to the ground and off to medical attention. Although it would probably not be essential, if something is available it may be a good idea to pad the rope which is around the armpits.

Figure 157 The Spanish Bowline

SPECIALTY KNOTS

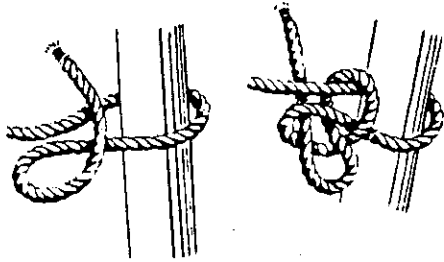

Figure 158 The Hitching Tie

Like the slippery hitch in Figure 118, the Hitching Tie may also be used as a rescue knot if an extra small line was tied to the working end of the knot and then extended down to the bottom of the escape knot. When a person slid down to the bottom of the rope he could pull the smaller line which would dissolve the knot. The rope could then be retrieved.

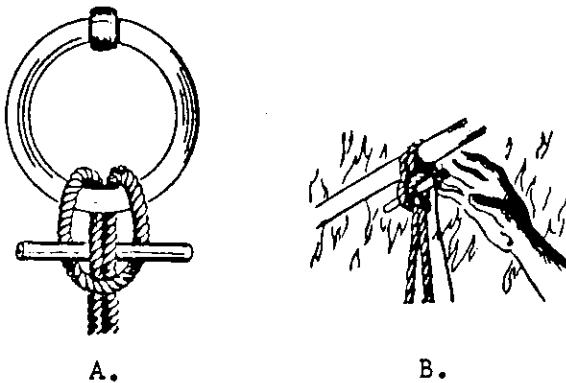

Figure 159 The Larkshead with a Toggle

The Larkshead with a Toggle is merely a larkshead tied in the middle of a rope and held fast with a toggle of some sort. Again, if one would attach a long small rope to the end of the toggle as in Figure 159-B, it would be possible to slide down the double rope and retrieve it quickly by pulling on the smaller rope to withdraw the toggle. This same principle could be used with a sailor's bowline.

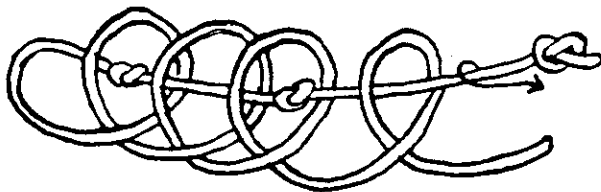

Figure 160 The Man Overboard Knot
or Fireman's Knot

The Man Overboard Knot or Fireman's Knot is simply a series of overhand (underhand) knots which is made by laying a series of underhand loops, each one laid on top of the other and then the free end is pulled through the loops resulting in a series of evenly spaced overhand knots. This knotted rope makes a rope much easier to climb or descend.

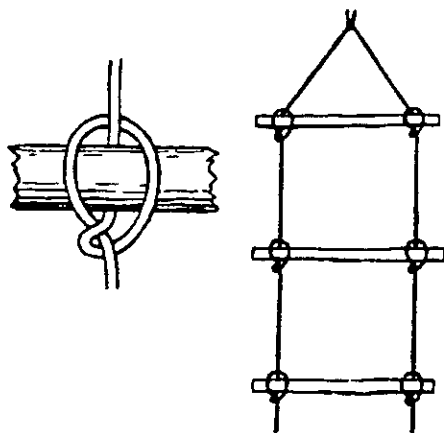

Figure 161 The Marline Spike Hitch

The Marline Spike Hitch is an excellent knot to put rungs on a rope ladder. First, lay out the proposed ladder. Then start at the bottom of the ladder and put a marline spike hitch in each leg of the rope so that the rungs are straight across. To make the hitch, make an overhand loop and push a bight of rope from the upper standing part through the loop and insert a rung through the bight. When making a rope ladder, be sure the half hitch is on the underside of the rung so that it will lock when the climber's weight is placed on it.

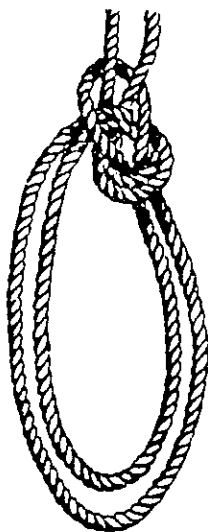

Figure 162 Bowline on a Bight

When lowering an injured person from a height, a Bowline on a Bight may be used as a "man-sling". One loop of the bowline should be made smaller than the other. The smaller loop is placed around the arm-pits and the larger loop around the knees. Either a man on the ground can lower the person by putting the rope above the knot around some type of holdfast near the victim, or the injured person could be lowered by the rescuer if he placed a round turn around a holdfast and then lowered the victim.

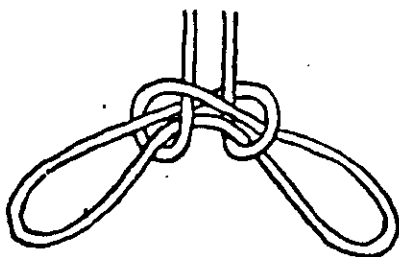

Figure 163 The Sheepshank used as a Man-sling

One of the principle uses of the Sheepshank is to shorten a rope without cutting it. It may also be used to take the load off of a weak spot in the rope. Another use for this knot is making a Man-Sling. This is done by jamming the two half hitches together as in Figure 163. This will make two adjustable loops.

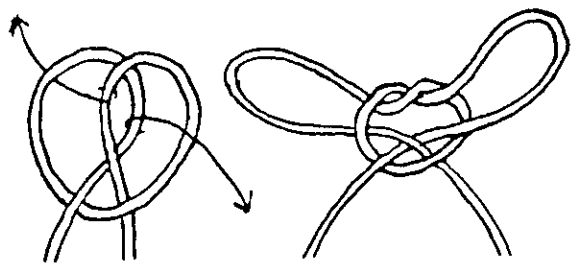

Figure 164 The Handcuff Knot or Tomfool Knot

The Handcuff Knot or Tomfool Knot may be used for handcuffs or the loops may be enlarged and a half hitch can be put over the end of each loop, snugged up and two fixed loops will result. This makes a good man-sling.

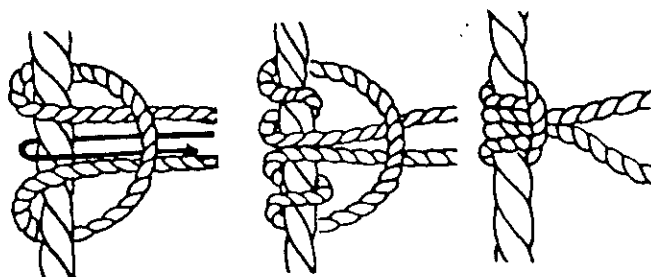
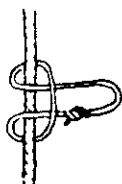

Figure 165 The Prusik Knot

The Prusik Knot is an excellent knot with many uses. It may be used for climbing and descending a large rope or pole. It can be used as a break on a traverse line by tying the knot around the traverse line and applying pressure by pulling on the ends of the rope as the equipment or personnel cross the traverse rope and descends to the end of the rope. It is also used to tighten a fixed line as in the double butterfly-prusik tightening arrangement as shown in Figure 197. When using a prusik knot for climbing, slings

will vary in size to fit the person and the rope or pole being climbed. Usually the sling will be about 6 feet in circumference. (See paragraph below.) Prusiking is discussed in Chapter 7. If a prusik knot has a tendency to slip, it is usually due to the needed tightening force and the load. When setting the knot, the thumb should be placed against the knot while the fingers grip the sling. Another way to make the prusik hold better is to pass the loop through itself three times instead of twice.



A.

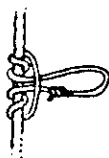

B.

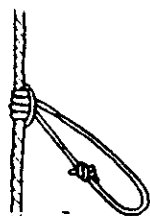

C.

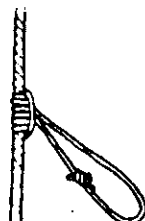

D.

Figure 166 The Prusik Knot Tied With a Sling

Rope Slings are loops of rope. They can be of any size but they usually vary from 3 to 12 feet in circumference. They can be bought ready-made or constructed from quarter inch rope (or larger) or they may be webbing. One of the best knots to use to make a loop rope is the flemish bend shown in Figure 167. This knot can then be secured on each side with a half hitch.

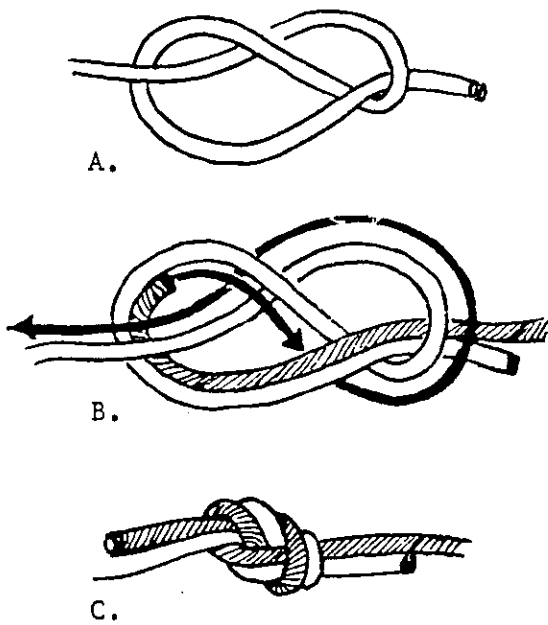

A.

B.

C.

Figure 167 The Flemish Bend

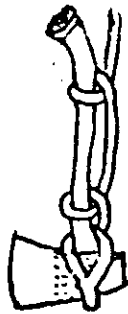

Figure 168 The Tool Sling

The Flemish Bend is one of the best knots to use in making a sling or rope loop. It is nothing more than two figure-of-eight knots intertwined together. It is good to secure this knot on each side with a half hitch. This knot is also a good knot for joining two ropes of the same or unequal diameters. If preferred, a double sheet bend could be used.

Often times it is necessary to raise or lower tools with handles such as a hammer or axe by means of a Tool Sling. A good procedure for this is to put a loop around the helve and leading the line around the head and finishing it off with 2 or 3 half hitches around the helve as shown in Figure 168.

The Water Knot (Ring Knot or Ring Bend) is the only knot to be used in webbing to tie ends together. However, it is a secure knot and may be tied in two different ways in rope as well as webbing. If both ends of the rope are available and if it is not important which line carries the strain, a simple overhand knot may be tied in the doubled rope.



The Water Knot

If it is important that the strains are parallel to the ropes, the knot is tied by first tying an overhand knot in one rope, then leading the second rope end along the first until the knot is formed.

CHAPTER 6

SPLICES, LASHINGS, ANCHORAGES AND TIGHTENING ARRANGEMENTS

INTRODUCTION

In order to have fun with ropes and poles, one must go a few steps further than knots. Most knots are a culmination of what has been done with a rope, or the knot may be the beginning process of what is going to happen with a rope. Therefore, the next step is learning a few basic splices so we can make rope easier to work with and use rope more efficiently. This may be followed by various lashings which will enable us to secure poles together so we can do everything from making furniture to simple machines. Being able to anchor a rope properly with either artificial or natural anchorages is another necessity in rope work. Then, of course, many times it is necessary to tighten a rope tighter than one can do by hand. Thus, we should be familiar with certain tightening arrangements used in rope work.

THE EYE SPLICE

There are a host of different kinds of splices, but if we can become familiar with a couple of eye splices, an end or back splice, a short and long splice we will have a good foundation.

Perhaps one of the easiest of splices is the tucked eye splice or dock-er's splice. Sometimes it is called the marline eye splice. This is a fast temporary splice when you need an eye in the rope in a hurry, and it will only have to remain in use temporarily. See Figure 169. The whole rope end is used to thread between the strands and the end should be left relatively long after it has been weaved through the strands of the rope.

The sailor's eye splice makes a good permanent eye splice. In making this splice, the rope ends must

Start with the easiest of all, the Docker's Splice, sometimes called the Tucked Eye Splice. This is a quick method of putting a temporary eye in a rope at any point and is often used by the makers of ridge tents to hold the doily of the main guylines. All splices are made by opening the lay and tucking one part of the rope through the other. In most splices this is done strand by strand and can only be done at the end of the rope. In the Docker's Splice the whole rope is used.

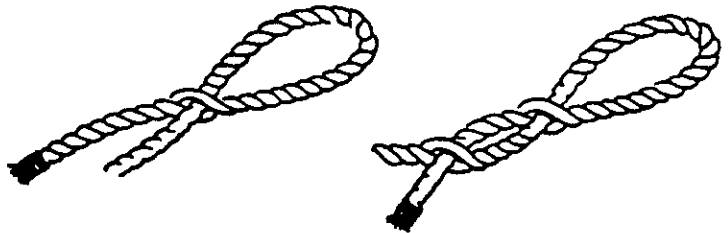

The important thing to remember in all splices is to work against (or across) the lay. In a hawser-laid rope the lay will run from left to right (clockwise) so your eye should be made against the clock. Open the lay at the chosen point in the rope and tuck the end through to make an eye of the required size. Now open the lay of the other part of the rope immediately below the first tuck and pull the other end through until both tucks lock together. If making the eye near the end of the rope, leave a reasonable tail and make sure that the end is securely whipped.

Figure 169 The Tucked Eye Splice or Docker's Splice

be untwisted to free up the three strands. Figure 170-A shows how each strand of the working end must always be inserted between a different strand of the rope's standing part. In other words, between each strand of a 3 strand rope, one of the working ends must go into the standing part between a strand and another strand must come out as shown in Figure 170-B. After the initial insertion of the 3 strands, it is very easy to check to see if you have started the splice correctly. As you turn the standing part, one strand should be sticking out between each strand of the rope and one strand should be going in. After this, it is merely weaving over a strand and under a strand with each of the 3 ends. The 3 strands of the working end should be woven through 3 successive standing part strands and snipped off.

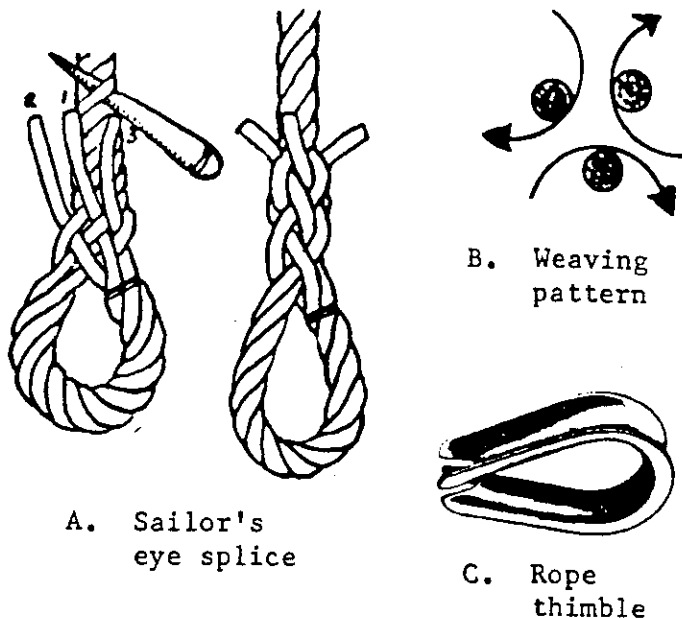

A. Sailor's eye splice

B. Weaving pattern

C. Rope thimble

Figure 170 Sailor's Eye Splice

If you wish to make a nicer looking splice, you must cut the working strands in half after the second or third tuck and weave the half strands in on a third and fourth tuck. This procedure cones the splice down gradually. Putting the finished splice on the floor and rolling it under your foot or rolling the splice between your palms helps to shape the splicing. If there are a lot of extra rope threads around the splicing, they may be cut and or burned off with a match or candle.

If desired, an eye splice may be formed around a rope thimble as shown in Figure 170-C. This maintains rope strength and reduces rope wear.

THE BACK OR END SPLICE

The back splice puts a nice looking finish on the end of a three strand rope. See Figure 171. The splice is started with a crow knot and then the tucks. It prevents unraveling and fraying. It is generally better than a whipping unless the rope has to be passed through an opening which is only slightly bigger than itself, such as a block. The splice is shown in four steps in Figure 171. Begin by de-stranding the rope for roughly six times its circumference. Hold the rope so that the three strands hang down, one

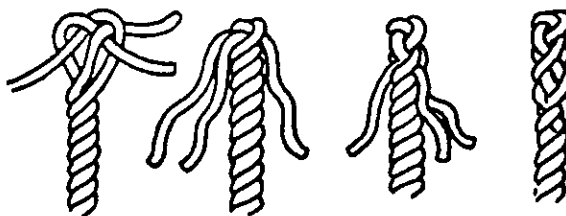
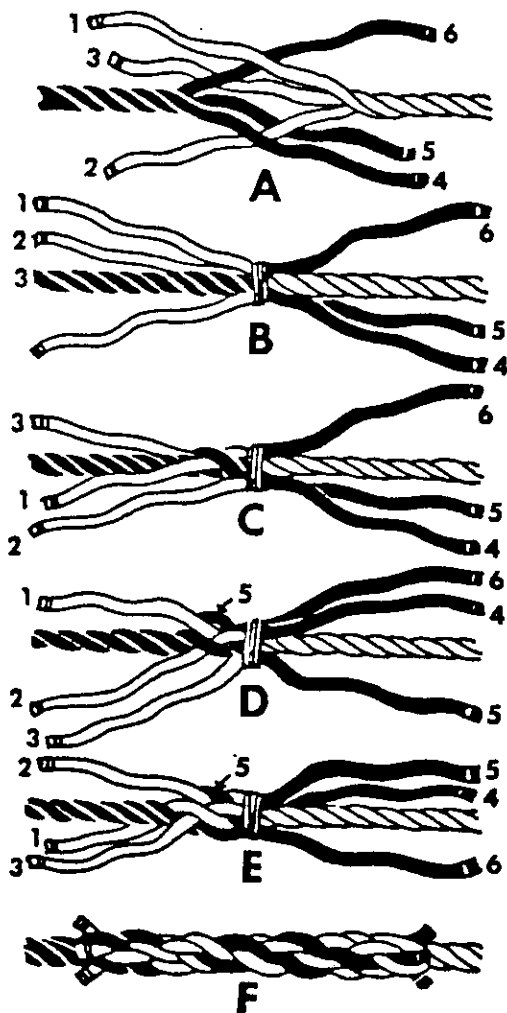

Figure 171 The Back or End Splice

at the back, the others at either side. Bring the back strand up and over to make an arch and hold it on the front of the rope with the left thumb. Make a similar arch over the top of the first with either of the other strands. Then weave the third over one and under the next, so that all three are held in a drooping position. Pull tight. Turn the rope away from you, and start tucking each strand in turn over the strand it touches under the next, pulling them back towards the crown from time to time to keep your splice as tight as possible. Three sets of tucks will be enough, after which the ends can be trimmed off and the splice rolled between the hands to make a neat finish.

THE SHORT SPLICE

The short splice shown in Figure 172-A may be used to join two pieces of rope of the same size. In the event a rope has a spot which has been severely worn or injured, the defective part may be cut out and the rope may be spliced together. It is also used in making slings or strops. A sling or strop is merely an endless piece of rope with various diameters depending on their use.



A. Short splice

SHORT SPLICE:

- A. Unlay each rope a few turns. Alternate the strands.
- B. Tie strands down to prevent more unlaying.
- C. Tuck strand 1 over an opposing strand and under the next strand.
- D. Tuck of strand 2 goes over strand 5, under the second, and out between the second and third.
- E. Repeat operation with strands 1 and 3 from same rope end.
- F. Remove tie and repeat operation on other rope end. Make two more tucks for each strand, roll tucks, clip ends.



B. Marrying

Figure 172 The Short Splice

After the two ends are unraveled four or five turns, the rope ends are brought together so that the strands of one rope alternate with the strands of the other piece of rope. This is called "marrying" as seen in Figure 172-B. The ends of one side should be tucked closely together with the other side and then taped or tied to the standing part to prevent further unraveling. This also prevents confusion and makes it much easier working with the other ends. The non-taped ends are then weaved into the rope putting each strand over and under twice or three times. Then the tape or string is taken off and the other side is done the same way. Each side should be woven with three tucks (more if desired). Smooth out the splice by rolling it under your foot. Trim the protruding threads with a scissors and candle or match.

THE LONG SPLICE

The long splice is shown in Figure 173. It takes more rope to make a long splice, but it makes a less bulky splice and it should, if made properly, be able to run through a block.

The making of a good long splice is an art. It is used less often than the short splice, and the process of making it requires much more rope. For the latter reason, it can seldom be done in practice unless old rope, past its usefulness, is available. When made by a skillful hand the long splice is difficult to detect and will run over the sheaves of a block without any trouble. The ropes to be joined should be the same lay and as nearly the same size as possible.

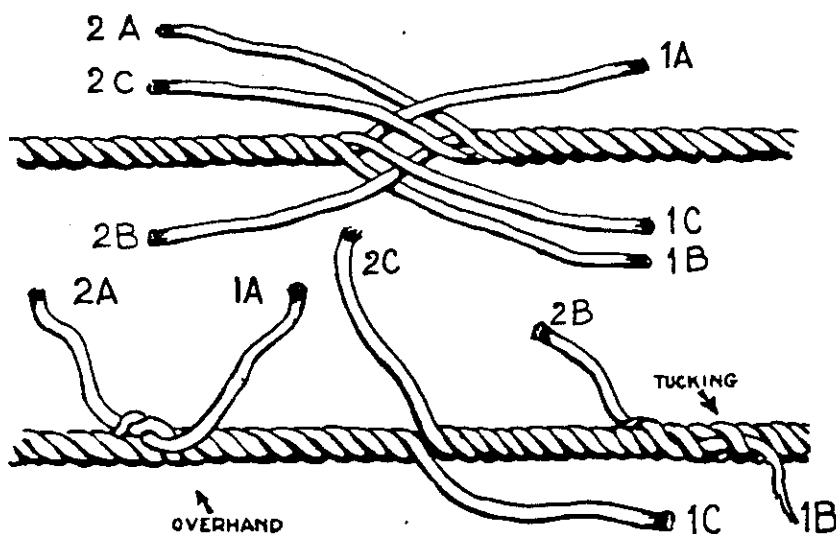

Figure 173 The Long Splice

To begin the splice, carefully unlay at least six times the circumference of the rope. (If the rope is to run over a sheave, unlay more than double that amount.) "Marry" the strands, as in the short splice, and hold them in close contact. Unlay strand 1A and fill its former place with strand 2A until only enough of strand 2A remains for the final hitch and tucks. Trim strand 1A down to the same length, and hitch the two strands with an overhand crossing, right to left. Repeat this process exactly the same with strands 1B and 2B. The strands 1C and 2C, now precisely in the middle, are simply tied there with the same hitch used to tie the others. Except for the protruding ends, the rope should now look like one continuous piece.

Tuck the strands over and under once, as is done in the back splice. Cut away about half of the yarn from the under side of each strand and tuck again. Trimming away the yarn gives a taper to the splice. Sometimes the trimming and tucking is done a third time. Then pound the tucks down into the lay of the rope, stretch the rope taut, and clip off the strand ends.

In another method (not illustrated), the strands are not tied with the overhand and the tucking is done with the lay, so that strand 1A, for example, would be wound about only strand 2A, instead of weaving under and over all three strands of the rope body. This method of following the lay ("sail-maker's method") is preferred by some experts for all splices.

INTRODUCTION TO LASHINGS

Like knots and splicings, there are many kinds of lashings. Lashings is a broad term with several meanings, but for our purposes the term lashings will denote a method of binding poles together in different positions with a piece of rope. It is also used for wrapping and fastening, such as binding a rope to a tool, etc. It may also denote binding two rope parts together with a smaller cord; however, this is usually considered seizing. The lashings that we will consider here are: The Traditional Square Lashing, the Japanese Square Lashing, the Diagonal Lashing, the Round Lashing, the Traditional Shear Lashing, the Square Shear Lashing, the Traditional Tripod Lashing, the Sailmaker's 3 Pole Lashing and the Sailmaker's 4 Pole Lashing.

LASHING LENGTHS AND THICKNESSES

Lashing ropes will have to vary with the size of the poles being used. A formula that is often used is to consider about one yard of lashing for each inch of the combined diameter of the two poles being used. If you are lashing a two inch pole to a four inch pole, you will need approximately 6 yards or 18 feet of lashing rope. Most of the lashing requirements fit this formula, except for the Japanese square lashing which needs to be about one third longer.

Thickness of lashing ropes will be determined by the thickness of the poles being lashed together. For poles up to $1\frac{1}{2}$ inches in diameter use twine or sash cord. Twine is very poor but it is cheap. For poles between $1\frac{1}{2}$ and 3 inches, use $\frac{1}{2}$ inch cotton rope. For poles over three inches in diameter, use a rope with a $\frac{3}{8}$ inch diameter.

THE TRADITIONAL SQUARE LASHING

The traditional square lashing (Figure 174) is used whenever two poles cross, touching each other where they cross. It has nothing to do with the angles at which the poles are set to each other. The lashing is started with a clove hitch around the upright, immediately

under the cross piece. Twist the end of the clove hitch around the standing part. In wrapping the first 3 or 4 turns, the rope goes on the outside of the previous turns around the crosspiece; on the inside of the previous turns around the upright. Keep the rope tight at all times and make a smooth job. The wrapping procedure is shown in Figure 174 followed by the frappings. After the wraps, the frapping turns go on between the spars to help tighten the wrapping turns. Strain the 2 or 3 frapping turns tightly and finish with a clove hitch. Remember, start with a clove, wrap thrice, frap twice and end with a clove.

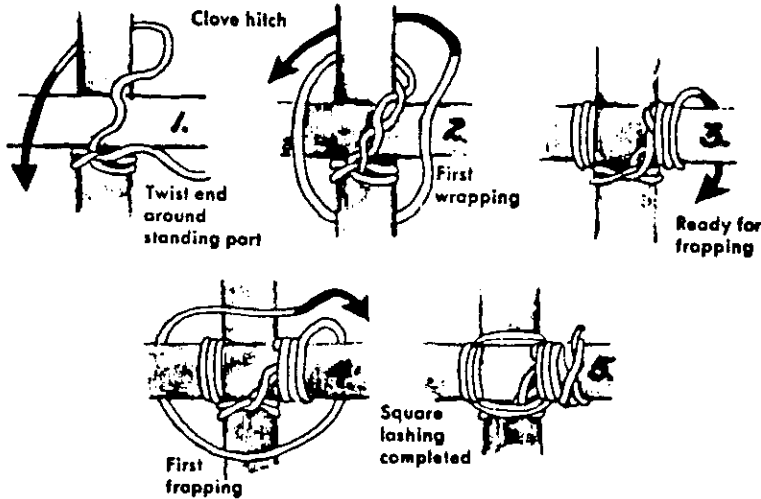

Figure 174 The Traditional Square Lashing

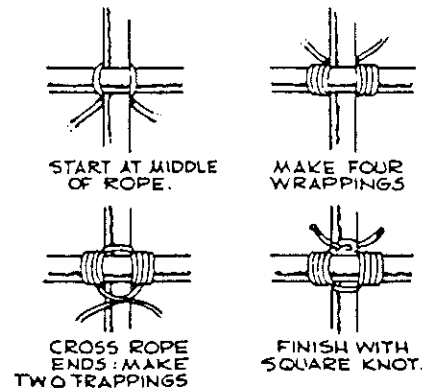

Figure 175 The Japanese Square Lashing

THE JAPANESE SQUARE LASHING

The Japanese square lashing (Figure 175) is a lashing equally as good as the traditional square, but it is easier to apply even though the lashing rope has to be one third longer than the lashing for the traditional square. Start the lashing by doubling the rope and passing the bight in back of the upright. Keeping the two rope ends side by side and never over-riding previous turns, take two complete turns around both poles as in Figure 175. Then split the doubled rope and make two or three frapping turns in opposite directions, pulling tightly and then finish with a square knot.

THE DIAGONAL LASHING

Diagonal lashing (Figure 176) is used when two poles have a tendency to spring apart. It has nothing to do with the angle of the two poles being lashed together. If two poles have to be pulled together in order to make them touch each other, a diagonal lashing is indicated. Start by pulling the two poles together with a timber hitch. When wrapping the turns, be sure that the turns lay beside each other rather than overlapping each other. Take three more turns, this time cross-wise over the previous turns. Pull tightly. Make 2 or 3 frapping

turns between the poles around the wraps and finish with a clove hitch around any convenient pole.

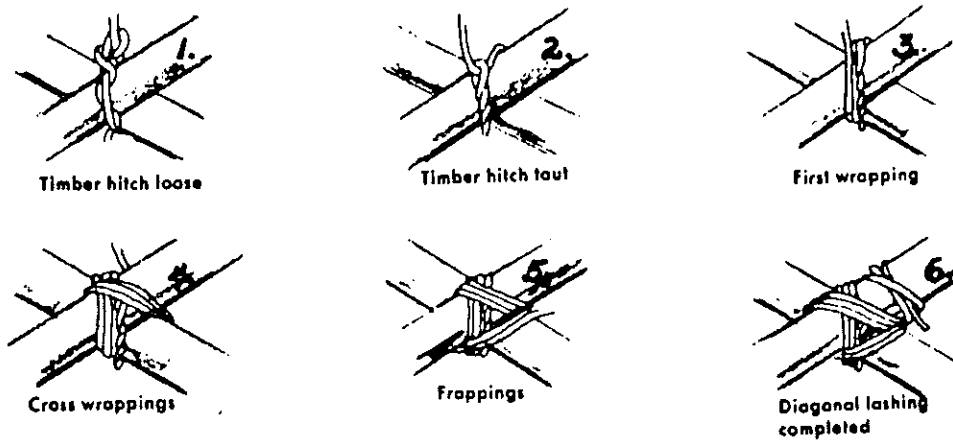

Figure 176 The Diagonal Lashing

THE ROUND LASHING

The round lashing as shown in Figure 177 is used to extend several shorter poles into a longer pole. Place two poles side by side overlapping the poles from $1/4$ to $2/3$. Put a tight clove hitch around both poles and tightly make 7 to 10 wrappings around both poles. Then finish with a tight clove hitch around both poles. It requires 2 lashings for each pole that you want to lash together.



Figure 177 The Round Lashing

THE TRADITIONAL SHEAR LASHING

The traditional shear lashing (Figure 178-A) is made by laying two poles together, which when finished, will make shear legs as shown in Figure 178-B. Place a clove hitch around one of the poles. Then lash the two poles together with 8 or 10 loosely laid wrappings. Then take two frapping turns around the wrappings and finish with a clove hitch around either one of the poles. This lashing will tighten as the shear legs are spread apart. If a crosspiece is needed on the lower aspect of the legs, it is lashed on with a square lashing. See Figure 178-C.

THE SQUARE SHEAR LASHING

The square shear lashing (Figure 179) is another method of tying shear legs together. Start the lashing by laying the lashing rope

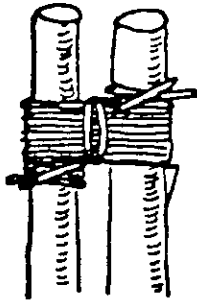

A. Traditional Shear Lashing

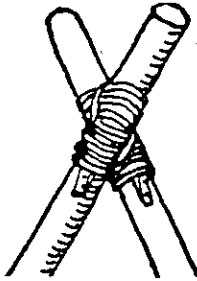

B. Opened Shear Legs

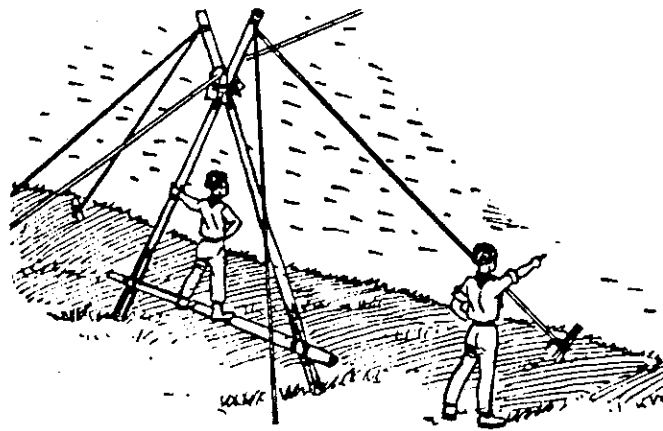

C. Shear Legs with Crosspiece

Figure 178 The Traditional Shear Lashing

between the two poles near the end. Let the short 12 to 15 inch end hang free. Then with the long end wrap the two poles 8 to 10 times keeping the wraps snug and close together. Allow the second 12 to 15 inch end to hang free between the poles with the two ends coming out on the same side. Frap the wraps once or twice by taking the two ends around the frapping turns in different directions and finish off with a square knot. The sheer legs are now ready to be spread. This lashing is just as good as the traditional shear lashing.

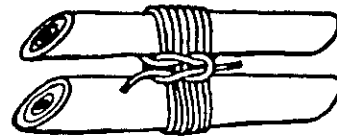

The Square
Figure 179 Shear Lashing

THE TRIPOD LASHING

The tripod lashing is seen in Figure 180-A. Place three poles beside each other and put a clove hitch around the outside pole with a lashing rope. Then bring the rope over and under the poles 5 to 7 times, figure-of-eight-wise. Finish with two loose frappings and a clove hitch around one of the poles. To make the tripod, spread the poles as in Figure 180-B.

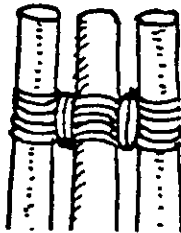

A. The Traditional Tripod Lashing

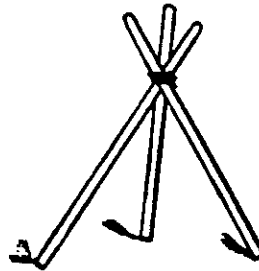

B. A Lashed Tripod

Figure 180 The Tripod Lashing

THE SAILMAKER'S 3 POLE LASHING

The sailmaker's 3 pole or tripod lashing is another method of making a tripod. It is clearly illustrated in Figure 181 from start to finish. This is not only a good lashing to use but it is a very good looking lashing. After the three poles are wrapped 8 - 10 times the bight is brought up over the indicated pole and pulled taut by pulling on the two ends. The bottom rope end is then brought up and over the wrappings between the poles where there is no vertical rope laying and the two ends are tied together on top of the lashing with a square knot.

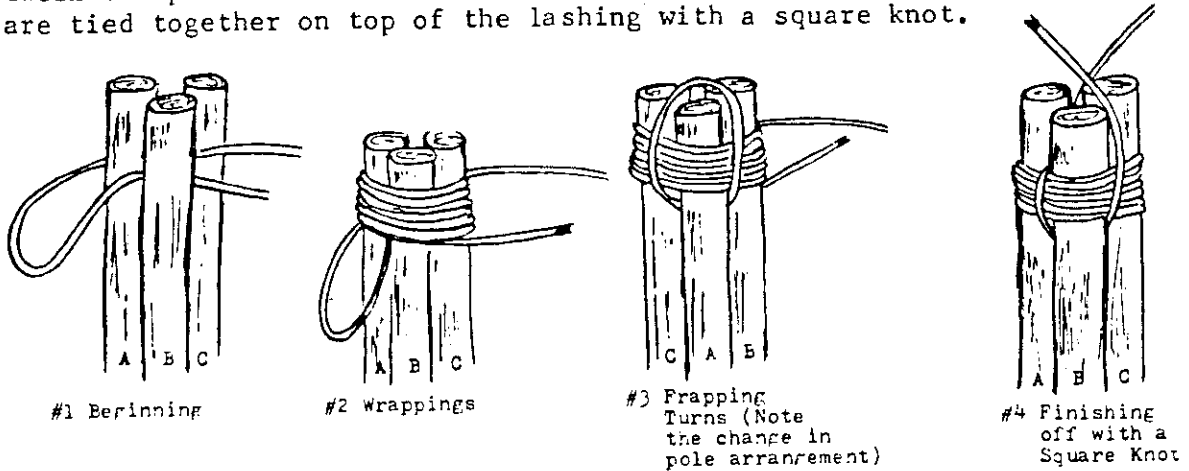

Figure 181 The Sailmaker's 3 Pole or Tripod Lashing

THE SAILMAKER'S 4 POLE LASHING

This lashing is made to lash 4 poles together into a quadruped. It is illustrated in Figure 182-A. It is started with a modified figure-of-eight around two of the four poles. Then it is wrapped from the bottom up as in the 3 pole lashing 8 to 10 times. After the wrappings are on, the two loops are flipped up and over the indicated poles on each side and tightened down. The bottom end is then brought up between any two of the poles and secured to the other end with a square knot. This makes an excellent lashing for building a Chippewa table as seen in Figure 182-B.

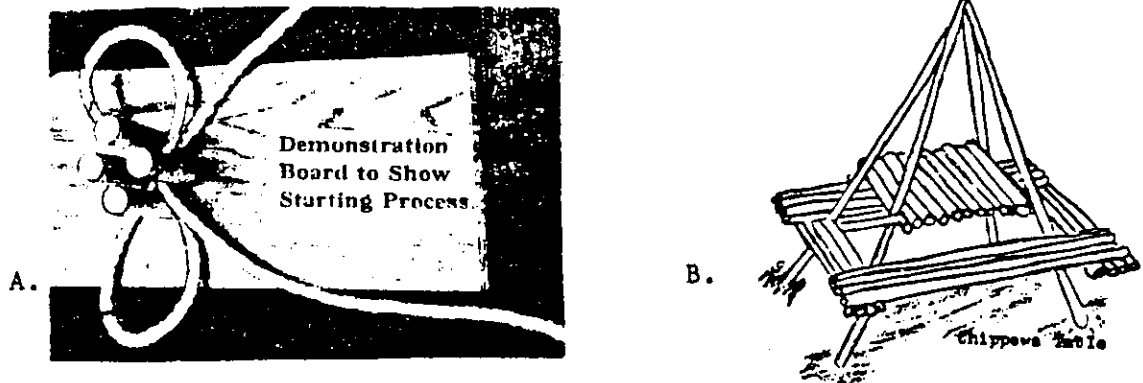

Figure 182 The Sailmaker's 4 Pole Lashing

SEIZINGS

Seizing is the temporary lashing or whipping together of two rope parts with a smaller cord. Seizings are usually applied only to larger sized ropes, and the seizing usually secures two parallel ropes together, or it may be used to form an eye in the rope or to secure a loop to another part of the rope.

Although there are several methods of seizing, a simple method is to wrap a few roundturns around the parts to be seized and finish off with a square knot. See Figure 183.

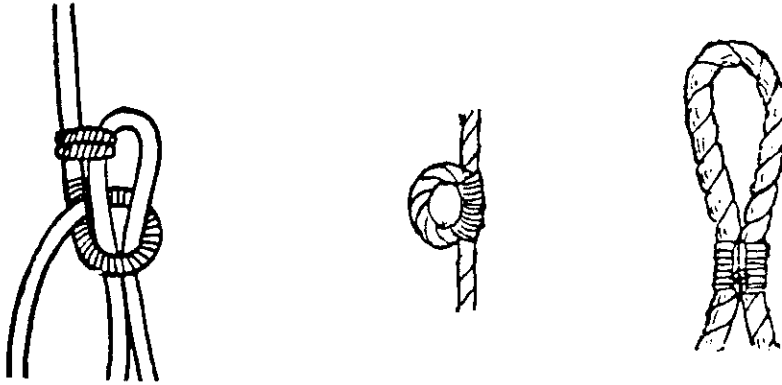

Figure 183 Rope Seizings

ANCHORAGES

In setting up rope installations the problem of proper anchorage can be vital. When we are in the woods usually trees become the universal anchors; however, sometimes it is necessary to erect makeshift anchors.

Anchors are usually classed as natural or artificial. Natural anchors are always preferable. The ideal situation is to have a firmly rooted tree or a solid rock nubble, but even these must be checked closely for firmness and strength. See Figures 184 and 185.

Most of the artificial anchors consist of the earth auger anchors, pickets or stakes, log and picket holdfasts, deadman anchorage, the bear claw, and the grappling hook.

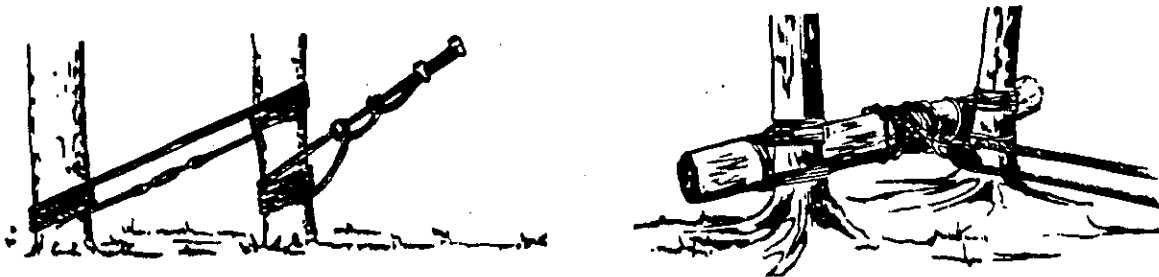

Figure 184 Two Types of Natural Tree Anchorages



Figure 185 Natural Rock Anchorage

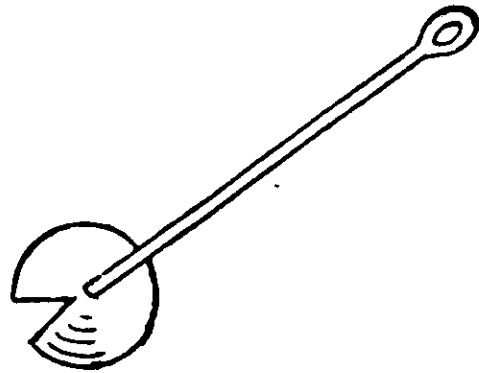

Figure 186 Earth Auger Anchor

THE EARTH AUGER ANCHOR

The earth auger anchor is an excellent anchor and reasonably priced. They come in a variety of sizes from 1 to 6 feet long with flanges from 2 to 12 inches in diameter. They screw into the earth leaving an eye for anchor attachment. See Figure 186.

THE SINGLE PICKET HOLDFAST

The single picket holdfast, as shown in Figure 187 is probably the most popular of the temporary anchorages. Stout pickets from 2 to 3 inches in diameter should be buried in the ground at least 3 feet. One picket should take a load of about 700 pounds.



Figure 187 Picket Holdfast

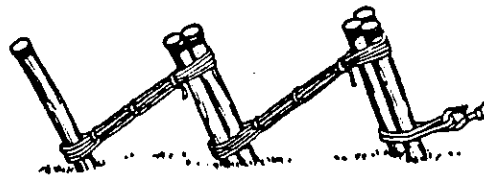

Three-Two-One
Figure 188 Picket Holdfast

THE 3-2-1 PICKET HOLDFAST

This anchor is shown in Figure 188. It consists of 6 pickets in groupings of 3, 2, and 1 - one behind the other. These pickets must be lashed together tightly, the lashings extending from the top of the front three pickets to the bottom of the next two pickets. Then again another lashing is used from the top of the second two pickets to the bottom of the last picket.

A variation of this holdfast, also called a 3-2-1 picket holdfast, is the method of using 3 pickets one behind the other and lashed together as above. Both types of 3-2-1 picket holdfasts should be able to take a strain of 2 tons.

THE LOG AND PICKET HOLDFAST

A log and picket holdfast such as the one shown in Figure 189, is another form of anchor which will hold at least 2 tons. In this type of anchorage, as in all other types, the angle between the rope and the ground should not exceed 25 to 30 degrees.

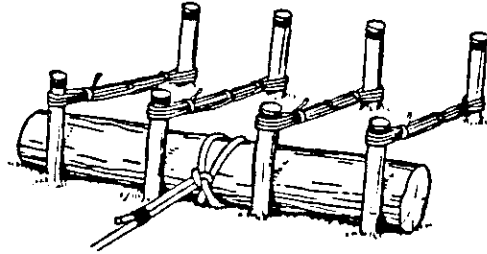

Figure 189 Log and Picket Holdfast

THE DEADMAN ANCHORAGE

The deadman anchorage is the safest type of anchor although it is more work to construct. A log six feet long and 6 inches in diameter should be buried three feet deep. From the middle of the log a small trench is made at an angle of between 25 and 30 degrees to house the rope or cable which is fastened between the pull and the log. A few pickets are then driven in in front of the log and the earth is placed back into the log hole. The completed anchor appears as in Figure 190.

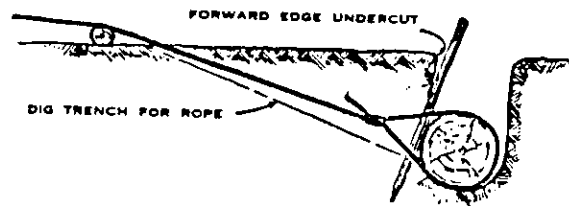

Figure 190 Deadman Anchorage

THE BEAR CLAW

Figure 191-A shows the top and side view of a bear claw anchor. This anchor may be easily made and often times it can come in very handy as another type of earth anchor if there is no other type of anchorage at hand. The bear claw works best if an 8 to 10 inch thick section of sod can be taken out. The claw can then be placed under the sod and the spikes of the claw can be pushed well into the ground. The rope can then be attached to the ring of the claw and the sod replaced. The pull on a bear claw should be horizontal for a few feet before the strain goes up or down. See Figure 191-B.

THE GRAPPLING HOOK (GRAPNEL)

The grappling hook is another device for anchorage. These are difficult to get commercially, but they can easily be made and a small

group can have a lot of fun with this item. It is discussed in more detail in the next chapter.

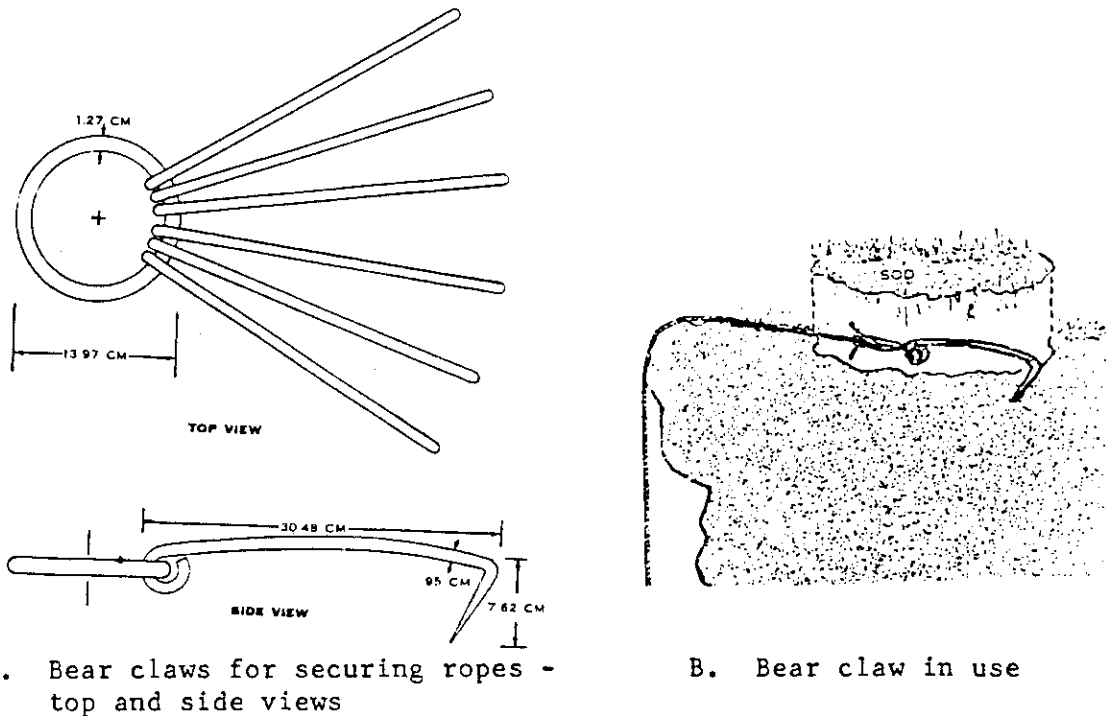

Figure 191 The Bear Claw

TIGHTENING ARRANGEMENTS

Quite often, in making rope installations and structures it becomes necessary to tighten ropes tighter than what can be done by hand. Often times a simple machine such as a winch, turnbuckle or hoist can be used very effectively. When making rope bridges, traverse lines, runways, tramways and holding lines, it becomes necessary to give them an extra stretch. Because of the fact that both manila rope and nylon have a stretch factor, often times a rope has to be periodically retightened. Some of the best ways of tightening ropes are with a hand winch hoist, a turnbuckle, a block and tackle, a Spanish windlass, the hayman's hitch and the double butterfly-prusik tightening arrangement. The lumberjack's pulley can be used, but it is cumbersome to make.

THE HOIST

These are commercial tools that can be purchased quite inexpensively. A 3/4 to 2 ton hoist as shown in Figure 192-A will pull a lot of weight and will do a good job. If you want to tighten a rope or cable with it, you can attach the one hook of the hoist to the rope to be tightened. The hook on the other end of the hoist can be hooked to a wire sling or piece of chain which goes around a tree or other anchor. Most hoists have a steel latch hook across the throat of the hook, as

shown in Figure 192-A; but if not, sometimes it may become necessary to "mouse" the hook. Mousing is the term applied to enclosing the mouth of a hook with a cord or wire to prevent the load from spilling. The cord is wrapped across the throat, around the neck and the bill end is tied off with a square knot. See Figure 192-B. If a wire is used, the ends may be twisted together with a pliers. Figure 192-C shows the nomenclature of an eye hook.

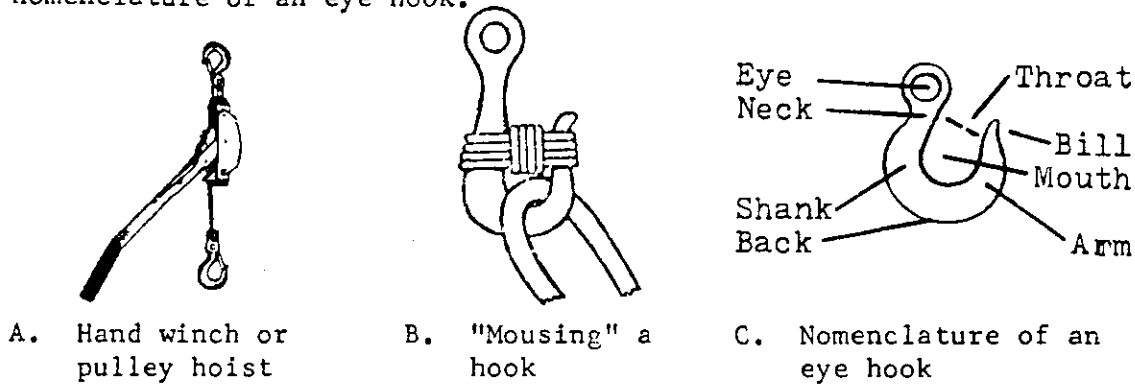

Figure 192 The Hoist

THE TURNBUCKLE

Figure 193 shows several turnbuckles. A turnbuckle is a device that consists of a kind of coupling for use between two lengths of threaded rod, consisting of a metal loop or sleeve with opposite internal threads at each end or it may have internal threads at one end and a swivel at the other end. The effective length of the rod can be increased or decreased by turning the loop thus loosening or tightening a rope or wire. For rope tightening, the larger the turnbuckle the better.

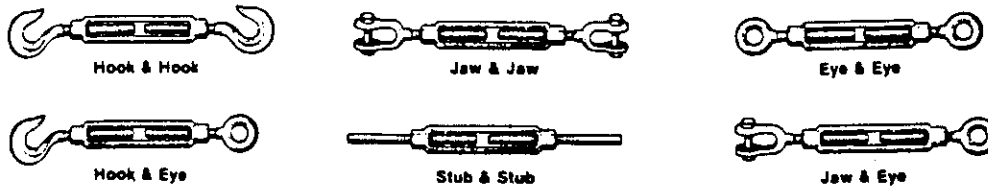

Figure 193 Types of Turnbuckles

THE BLOCK AND TACKLE

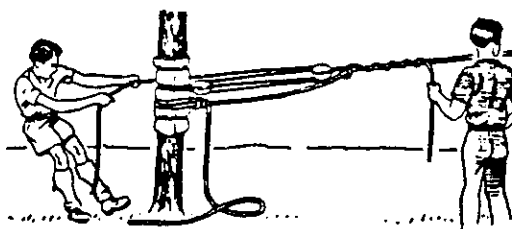

Figure 194 Block and Tackle

The block and tackle as seen in Figure 194 is an excellent and inexpensive device for producing more pulling power. The more sheaves in the block, the greater the mechanical advantage. This is discussed in more detail in Chapter 4.

THE SPANISH WINDLASS

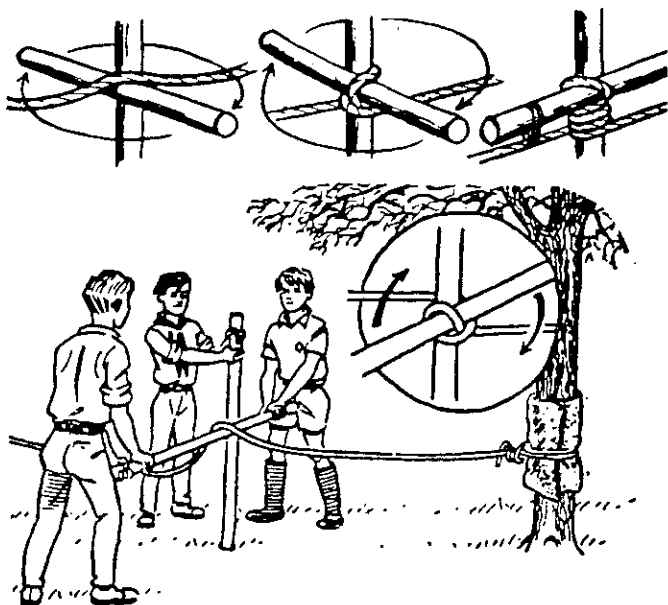

Figure 195 The Spanish Windlass

The Spanish windlass is used for increasing the strain on a rope without a block and tackle. Drive one spar firmly into the ground in line with the rope. Pick up the slack in the rope with the other spar and start turning, keeping the horizontal spar above the rope. Beware of the kick-back - it will recoil like a spring if released. To hold the strain, lash both ends of the horizontal spar to the rope. The Spanish windlass is illustrated in Figure 195.

THE HAYMAN'S HITCH

This tightening arrangement is also called the harvester's hitch or the rope tackle. Figure 196 shows the arrangement, which is nothing more than a half sheepshank, but it can be used to increase the mechanical advantage and give you more pulling power when tightening a rope.

Assuming you want to tighten a rope, put a harvester's hitch in the rope close to the anchor point. The small loop with the half hitch is pointed toward the tied off end. The rope is then stretched around some type of anchor such as a tree and back through the large loop of the knot. As you can see in the illustration in Figure 196, pulling on the end of the rope

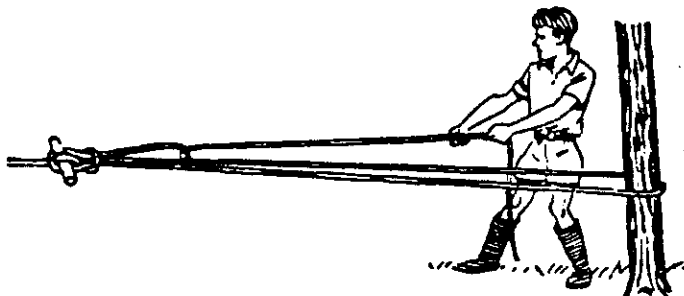

The Harvester's
Figure 196 or Hayman's Hitch

works like a block and tackle and increases the mechanical advantage. The small loop in the knot definitely has to be seized or toggled to the main rope to prevent the knot from upsetting. The same thing could be done by placing an overhand loop in the rope instead of a harvester's hitch, but it would be much harder to untie.

THE DOUBLE BUTTERFLY-PRUSIK TIGHTENING ARRANGEMENT

This is an excellent method of tightening a larger rope. It looks more complicated than it is, but it is clearly illustrated in Figure 197. The two loop butterfly is made with one large loop and one small loop. A prusik knot is tied in the middle of the larger loop so that when the rope is pulled for tightening, the prusik knot will hold the tightened portion of the rope while the puller gets another grip on the rope. When the rope is well tightened, the end must be well anchored with a tie off knot. Do not rely on the prusik knot for permanent anchorage. It will hold temporarily, but when the rope gets bounced and pulled the prusik knot will loosen. Be sure to tie off the end.

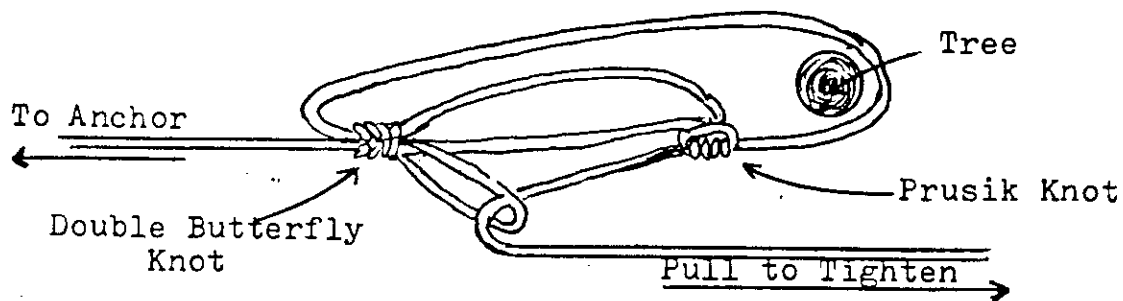

Figure 197 The Double Butterfly-Prusik Tightening Arrangement

THE LUMBERJACK'S PULLEY

Figure 198 shows the lumberjack's (or lumberman's) pulley which is another form of a tightening arrangement that gives a block and tackle effect on the rope. Although this is a troublesome arrangement to make, it is effective for tightening, and all things being equal it will produce more mechanical advantage than a hayman's hitch.

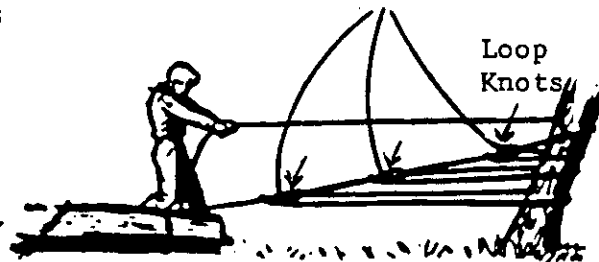

Figure 198 Lumberjack's pulley

There are many forms of tightening arrangements. The above are some of the best for those who like to do things.

CHAPTER 7

ROPE SPECIALTIES

INTRODUCTION

Perhaps most any maneuver with a rope could be classed as a rope specialty, but for the purpose of this chapter we will cover a few specialties including some of the methods of climbing and descending a rope with and without aids. It will introduce some of the basic climbing equipment as well as technics for rappelling, wall climbing and belaying. It will introduce the use of commando ropes, rescue knots, the life basket and tree evacuation. We will bring into play the art of "getting a first line across," various types of rope bridges, rope traversing, cable systems and the boatswain's chair.

FREE ROPE CLIMBING

Free climbing a vertical rope (Figure 199) can be a tough job. By using various types of holds, knots, chocks and rungs, ropes can be made into types of ladders quite easily.

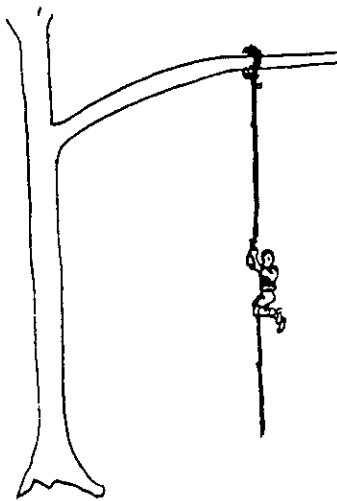

Figure 199 Free Climbing on a Vertical Rope

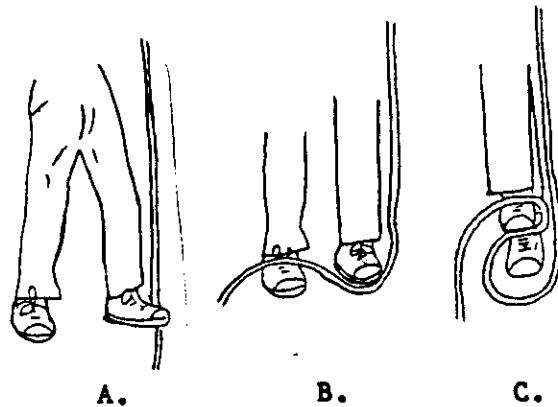

Figure 200 The Footlock

THE FOOTLOCK

This is a method of using your feet to lock your position while climbing or descending a rope. By using the footlock, you can climb a rope and still stop to rest when your arms tire.

The footlock is made by holding on to the rope with both hands, lifting the knees and kicking the rope to the outside of one foot. The foot on the opposite side of the rope is pointed downward so that the toe picks up the rope, which is pulled over the foot which was against the rope, and under the instep of the foot which picked it up. The two feet are then brought together and the rope is now over the instep of one foot and under the ball of the other. The feet are then placed one on top of the other so that the rope is clamped down by the foot on top. By straightening the knees and raising the hands, the body is lifted and a fresh grip taken for the next rise. See Figure 200. In descending, the body is bent, the hands are lowered, and the footlock is released. A fresh grip is taken with the feet at a lower level on the rope.

THE MAN OVERBOARD KNOT

This knot, also called the firemen's knot or Philadelphia knot, is seen in Figure 201. It is a method of making a knotted rope by laying a series of underhand loops placing one on top of the other, and then pulling the free end of the rope down through the loops. This results in a rope with evenly spaced overhand knots. A knotted climbing rope is much easier to climb than a straight rope without knots because the knots can be used for hand holds and foot rests.

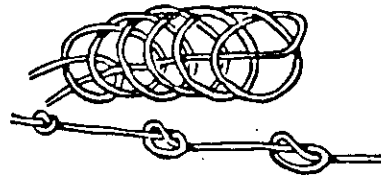

Figure 201 The Man Overboard Knot

"CHOCK" ROPE CLIMBING

A chock is a wedge, or block of hardwood, with a hole suitably drilled through it to take the diameter of a climbing rope. The chock can then be held in place by inserting small pegs between the rope strands under the chock. The climbing rope is then seized with some sort of cord or binding below the pegs. An alternate method would be to tie an overhand knot in the climbing rope below the chock. See Figures 202 and 203 for different types of chocks.



Figure 202 Types of Chocks



Figure 203 A Chock Ladder

A STICK LADDER

A single rope ladder may be made by opening the lays of the rope and inserting crossed sticks each about 8 inches long. The sticks must be large enough in diameter to hold the climber's weight without breaking.

After the crossed sticks are in place, with the middle of the crossed sticks in the center of the rope, the sticks are secured to the rope by seizing the rope above and below the sticks with a smaller cord or binding. Place the crossed sticks about 16 inches apart so as to make a comfortable step. See Figure 204.



Figure 204 Ladder with Stick Rungs



Figure 205 Loop Knot in a Single Rope

THE LOOP KNOT LADDER

Another method of climbing a single rope is to make a series of loop knots (also called overhand loop knots) in the climbing rope. The loop must be large enough to accept the climber's foot easily and the loops should be spaced from 12 to 18 inches apart. See Figure 205.

SPACED OVERHAND KNOTS IN A DOUBLED ROPE

Figure 206 shows how to make a rope ladder out of a piece of webbing or a doubled rope by tying a series of overhand loops in the doubled rope. By tying the knots alternately to one side, with a little slack in the rope, a flat step will be formed. If you use 3 to 4-step ladders of this type, they will work out beautifully as an improvised etrier called an "aid sling or stirrups."

THE ETRIER

Figure 207 shows an etrier, which is an inexpensive piece of mountain climbing equipment consisting of a 4 or 5 loop ladder which is made from heavily stitched nylon webbing with several thousand pounds test strength. The reinforced rungs are heavily stitched to stay open. Etriers are strong, light weight and easily handled. A

carabiner snaplink can be attached to the top reinforced nylon loop. The snaplink may then be attached to a piton, belay ring or a rope loop, etc.



Figure 206 Ladder made with Spaced Double Overhand Loops



Figure 207 An Etrier in Webbing

THE MARLINE SPIKE HITCH

Figure 208 shows how to make a marline spike hitch ladder. This is a rung ladder out of a doubled rope which is made by tying a marline spike hitch on each side of the doubled rope and positioning the ends of a rung through the hitches.

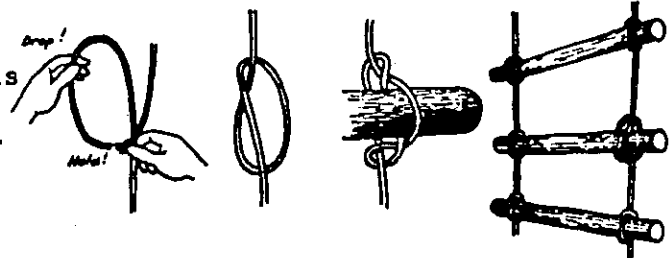

Figure 208 Marline Spike Hitch Ladder

PRUSIKING

Figure 209-A again shows the prusik knot and one way it may be used as an aid to climbing a large rope, a pipe or flagpole. For climbing with this method, two or three 12 to 18 foot pieces of 1/4 or 3/8 inch "sling ropes" are needed to tie on to the pipe or rope that is to be climbed. If you are not going to climb too high, 2 ropes for foot stirrups are sufficient. If you wish to climb higher, a chest safety rope is indicated, as shown in Figure 209-B.

To start, use a 15 foot piece of rope, double it and put a prusik knot in the bight around the rope or pipe to be climbed. A sailor's bowline may be tied in the two ends hanging down from each prusik knot to make suitable stirrups for the feet. Then with one foot in each stirrup and one hand on each prusik knot you can proceed

to climb by shifting your weight on to one foot and with the opposite hand elevate the prusik knot. The weight of the body is then shifted up to the opposite loop and the bottom prusik knot is brought up to meet the first. By constantly shifting your weight and raising the prusik knots, you can climb and descend easily.

If a prusik knot has a tendency to slip, pass the loop of the prusik knot through itself 3 times instead of twice. The closer the diameter of the sling rope approaches that of the fixed line, the greater the tendency of slippage, so the larger the rope to be climbed, the better. It should also be remembered that the prusik knot is hard to grip or loosen with cold wet hands.

If a third rope is used for a safety line, the middle of the rope is attached to the vertical rope with a prusik knot which should be positioned above the other two prusik knots. The two ends are then attached to a seat and chest harness. Using this method, the climber may assume a sitting type position and rest on a climb. This has been referred to as Texas prusiking. See Figure 209-C.

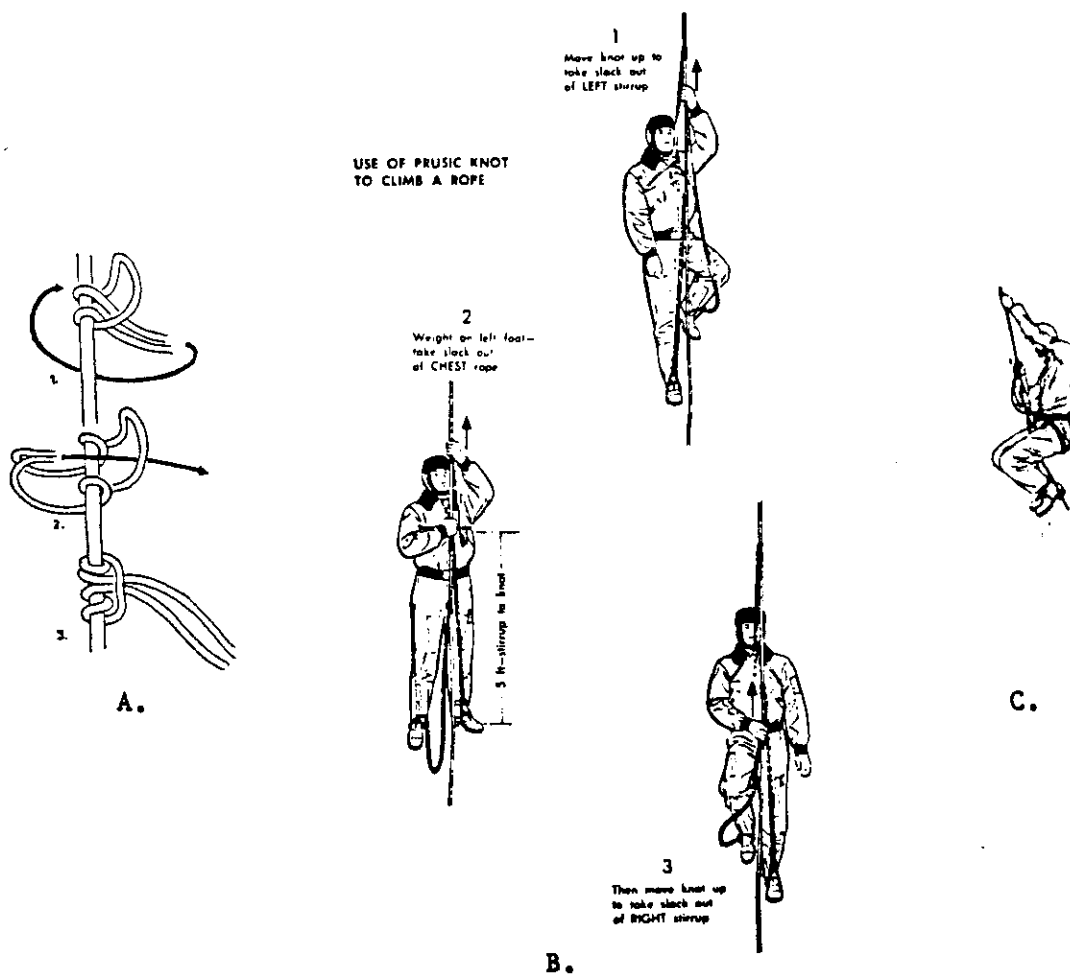

Figure 209 Prusiking

ROPE CLIMBING EQUIPMENT

We have already mentioned carabiner snaplinks and etriers as seen in Figure 210-A. Etriers provide optimum efficiency for direct aid climbing when a ladder-type aid is needed. Some of the other climbing equipment that can give hours and days of fun are seen in Figures 210 to 230. It must be remembered that when using climbing aids, beginners must use this gear on a small scale. This book does not attempt to make mountain climbers out of anyone. This equipment should only be used by the beginner on small cliffs, walls and trees.

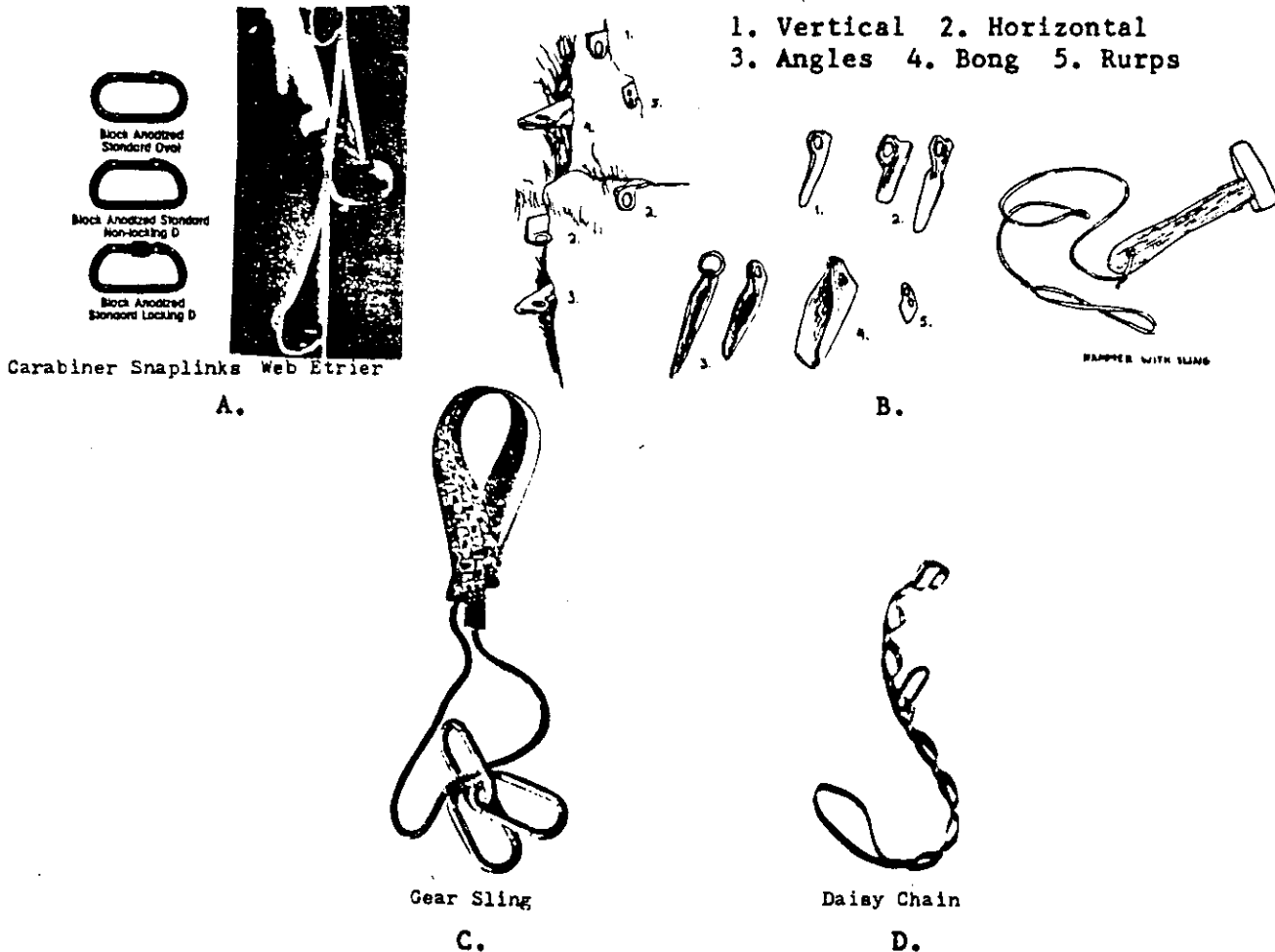

Figure 210 Rope Climbing Equipment

Pitons, as shown in Figure 210-B, are multi-shaped metal wedges which are hammered into ice walls or fissures on rock walls so as to make an anchor for a snaplink attachment. The snaplink, in turn, can accept a rope, sling or etrier, etc., to aid in a short climb. The piton hammer comes with a wrist sling so the hammer can't be dropped when climbing.

A gear sling is merely a web shoulder strap with a perion cord strongly attached to each end of the shoulder strap. It is designed

to be used over the shoulder and is used to carry snaplinks and other climbing aids. See Figure 210-C.

A daisy chain is a continuous loop nylon sling stitched into several carabiner length loops. The loops are designed to stay open under load, so it is always easy to clip in a carabiner snaplink. The daisy chain is an easily adjustable anchor line. It simplifies hanging belays and jumar ascents and lets you stay safely anchored while unroped. See Figure 210-D.

There are several types of rope climbing ascenders. Jumar ascenders (Figure 211), Kong ascenders (Figure 212) and Gibbs ascenders (Figure 213) are a few of the popular types. These are highly efficient prusik machines. These devices work on the prusik-friction principle and are designed for use on vertical ropes. Do not use them on a rope strung diagonally. With the Kong and Jumar ascenders one can go up as well as down a vertical rope. One ascender is used for each hand as shown in Figure 214.

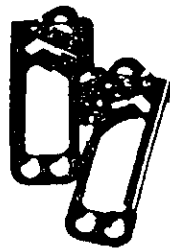

Figure 211 Jumar Ascenders

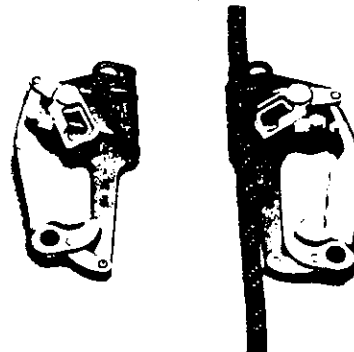

Figure 212 Kong Ascenders

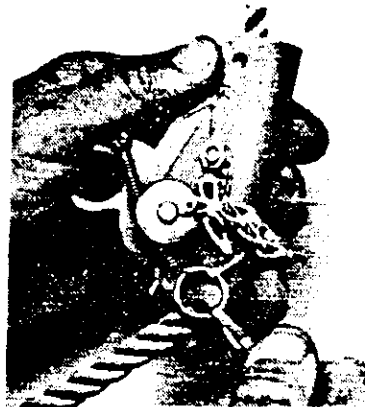

Figure 213 Gibbs Ascenders

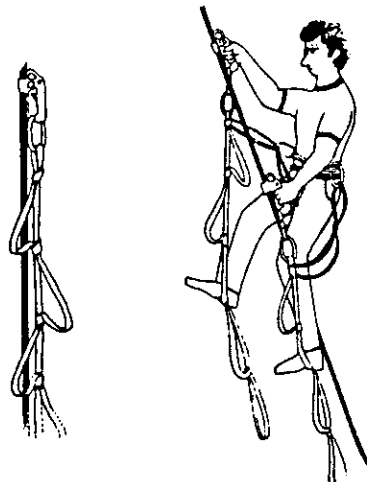

Figure 214 Using Jumar Ascenders

The Gibbs ascenders are used to ascend a rope only. One ascender is attached to the inside ankle of one foot and the other is tied just below the inside of the knee of the other leg. Two ascenders are needed for short climbs. If desired, and especially on longer climbs, a third

Gibbs ascender may be used as a safety by connecting it to a seat and chest harness. For the beginner, long climbs are not recommended. Figure 215 shows the use of the Gibbs ascenders.

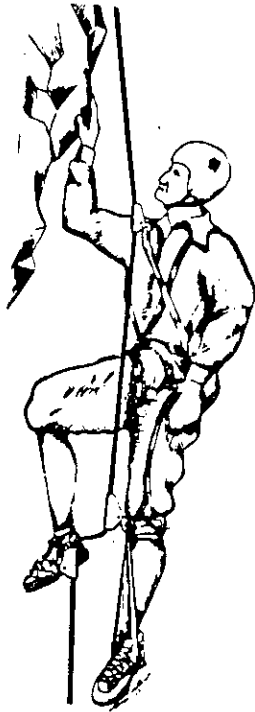
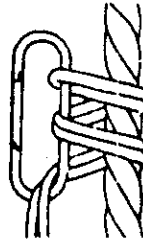
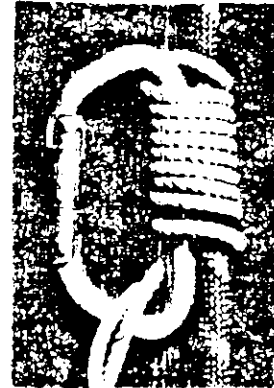

Figure 215 Using the Gibbs Ascenders



A. 2 loop



B. 3 loop

Bachmann Knot showing a 2 and 3 loop roundturn around a snaplink. Although not too successful, this may be used as a substitute for an ascender.

Figure 216 The Bachmann Knot

THE BACHMANN KNOT

This knot was developed in Austria in an attempt to modify the prusik knot to include a carabiner snaplink as a handle. Although it makes for a good program to experiment with, it is not real successful in mountain climbing. The development of the ascending devices have all but displaced the Bachmann knot. This knot is shown in Figure 216.

RAPPELLING

Rappelling is the art of descending a steep incline or cliff whereby a climber lowers himself by sliding down a climbing or rappel rope. Sometimes rapelling is referred to as "abseiling."

Rappel ropes must be in good condition without splices. The average rappel rope is 120 to 165 feet long. The minimum rappel rope must be at least 3/8 inch, three ply, 600 pound test manila and it must be more than twice as long as the incline to be descended. More recently, 9 - 11 mm man-made ropes with names such as Edelrid, Bidessin, Mammut and Skyline are far superior to manila in strength, weight and texture.

After you have found a suitable steep incline, you must first find a rappel point. This is a tree, projecting rock or other stationary point that the rappelling rope may be placed around so that the rope is suspended by its center. Try to select a rappel point close to the edge if possible using a good natural or artificial anchor. The rappel point should be higher than the loading platform if possible. Be sure to test the anchor for safety and retrievability of the rope. Avoid having the rope run over sharp edges and be sure the rope reaches the bottom of the cliff or a good unloading platform where another rappel point may be established. Try to keep away from areas of loose falling rocks or other obstacles. Four types of rappels will be discussed here.

THE HASTY RAPPEL

This rappel (Figure 217) is better on steep inclines rather than vertical walls. After the rope is around the rappel point and the ends are free all of the way down, the method is as follows:

1. Face sideways to the anchor point.
2. Place the rappel rope across the small of back.
3. Grab each side of the rope with outstretched arms.
4. Descend sideways, full sole, with body perpendicular to rock.
5. The upper hand is the guide hand; the lower is the brake hand.
6. To stop, bring the brake hand in front of body and turn facing the anchor point.



Figure 217 Hasty Rappel



Figure 218 Body Rappel

THE BODY RAPPEL

In the body rappel (Figure 218) after the rope is anchored and free, the climber faces the anchor point and straddles the rope. He then pulls the rope from behind, runs it around either hip, diagonally across the chest and back over the opposite shoulder. From there, the rope goes to the braking hand, which is on the same side as the hip the rope crosses. The rappeller should lead off with the braking hand and should face slightly sideways. The foot corresponding to the braking hand should precede the other at all times. The other hand, called the guide hand, should be kept on the rope above him just to guide but not to brake. The rappeller must lean out at a sharp angle to the incline keeping his legs well spread and relatively straight. In rappelling, never get the feet higher than the head. The collar should be turned up to prevent rope burns on the neck. It is a good idea to wear gloves and any other extra clothing for padding for the shoulders and buttocks.

In rappelling on larger cliffs, rappels are made from rappel point to rappel point in a series of descents. After the descent has been made, the rope may easily be recovered by pulling one of the rope ends until the opposite end passes around the rappel point above and drops free.

In beginning rappelling, it is always a good idea to use a safety rope along with the rappel rope.

THE SEAT-SHOULDER RAPPEL

Figure 219 shows the seat-shoulder rappel. A commercial or improvised rappel seat must be used. If you wish to make an improvised rappel seat, one method is to use a $\frac{3}{8}$ inch manila sling rope about 10-15 feet long depending on the size of the individual. This rappel seat is shown in Figure 220 A and B, and is made by following steps 1 through 4 below.

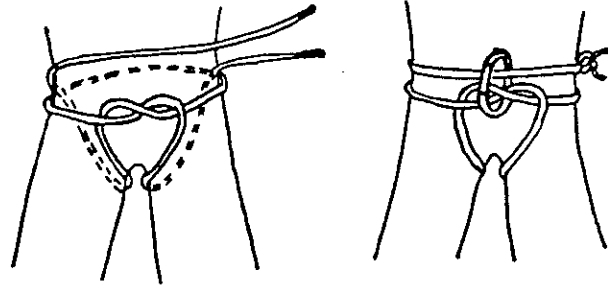

Figure 219 Seat-Shoulder Rappel

1. Place the center of the sling rope on the hip opposite the braking hand.
2. Bring the sling rope around the waist, tie an overhand knot over the belt buckle and bring the ends of the rope between the legs, around the hips, underneath the rope already around

the hips and then tie the ends together with a secured square knot on the hip opposite the brake hand.

3. Place a snaplink around the single rope which is around the waist and around the two ropes forming the overhand knot in front.
4. The snaplink should be inserted with the gate opening down and towards the body; then rotate one-half turn so that the gate opening is up and opens away from the body. This completes the seat-shoulder rappel seat.



A. Harnessing up with a 3/8 inch nylon or manila rope

B. Tie off with a secured square knot and attach snaplink

Figure 220 Improved Seat Harness for Seat-Shoulder and Seat-Hip Rappel

When using the seat-hip rappel, a second snaplink can be engaged on the first as shown in Figure 222-B. This just makes a little more room for the rappel rope. As seen in the diagram, the seat-hip rappel requires the rappel rope to be put around the snaplink twice. If a commercial seat harness is used, the second snaplink is not necessarily needed.

After the rope is anchored and the ends are free and your seat harness is in readiness, the seat-shoulder rappel is executed in the following manner:

1. Stand on one side of the rappel rope facing the anchor point.
2. Snap the doubled rappel rope into the snaplink which is on your seat harness as in Figure 221.
3. Pick up the rope behind the snaplink and lay it over the shoulder opposite from your brake hand.
4. Face around so the rope crosses the back.
5. Grasp the rope with the brake hand with palm side up.
6. Place the guide hand on the rope in front of snaplink.
7. With legs straight, feet should be shoulder width apart.
8. Lean well out to obtain full sole contact against the rock.
9. Allow the rope to run through the brake hand for a smooth even descent.
10. Face slightly sideways leading with the brake hand down.
11. Brake by bringing the brake hand across chest.
12. When descending look down over brake shoulder.

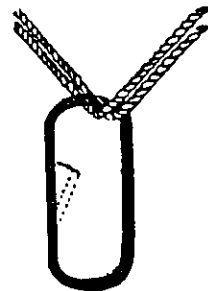

Figure 221 The Rappel Rope Snaplink Attachment for the Seat-Shoulder Rappel

THE SEAT-HIP RAPPEL

The seat-hip rappel is the most popular. It is shown in Figure 222-A. If a commercial seat harness is not available, tie an improvised rappel seat around the waist as described under the seat-shoulder rappel. Anchor the rappel rope and throw the ends clear. The execution of this rappel is made in the following manner:

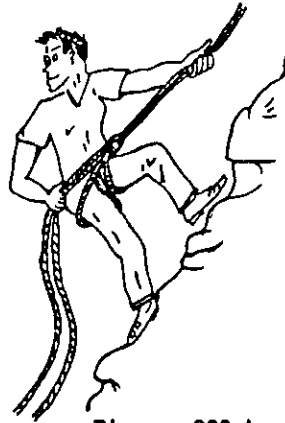

Figure 222-A
The Seat-Hip Rappel

1. Stand on one side of the rappel rope facing the anchor point.
2. Place the doubled rope into the snaplink as shown in Figure 222-B.
3. The rappel rope is held with the brake hand to the rear behind the buttocks, palm down, with the guide hand holding the rope in front of the snaplink.
4. Keep the legs straight with the feet a shoulder's width apart. Lean well out to obtain full sole contact against rock.
5. Allow rope to run through the brake hand for a smooth even descent.
6. Brake by closing the fist of the brake hand and pressing the rope down against the body.
7. Look down over the brake shoulder when descending.

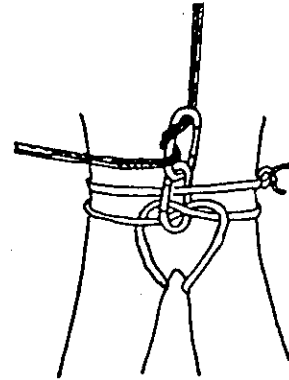

Figure 222-B The Rappel
Rope Snaplink Attachment
for the Seat-Hip Rappel

SEAT HARNESES AND RAPPEL SEATS

There are many different types and designs for rappel seats and seat harnesses. We have already discussed the improvised seat harness and how to tie it under the heading, "The Seat-Shoulder Rappel."

Figures 223 and 224 show two "diaper type" seats which may be made using rope or webbing.

Figure 225 pictures a commercial rappel seat made of webbing.

Figure 226 shows the snaplink attachment and a straight-figure-8 descender-belay device with the hook-up from the rappel seat to the rappel rope.

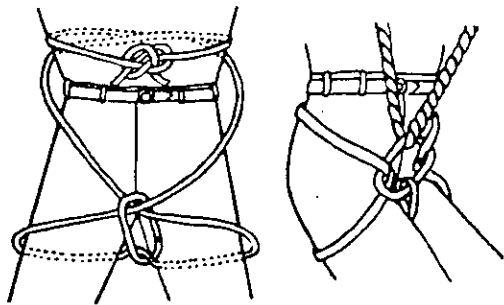

Figure 223 One Type of Diaper Sling

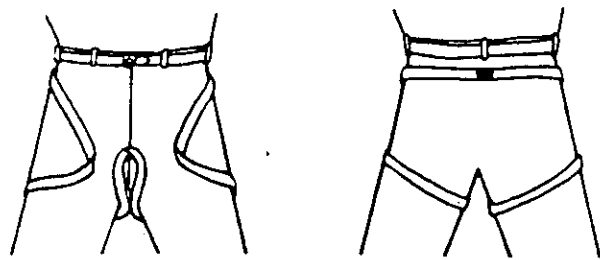

Figure 224 A Simple Improved Diaper Sling Made With an 8 Foot Endless Sling of Rope or Webbing

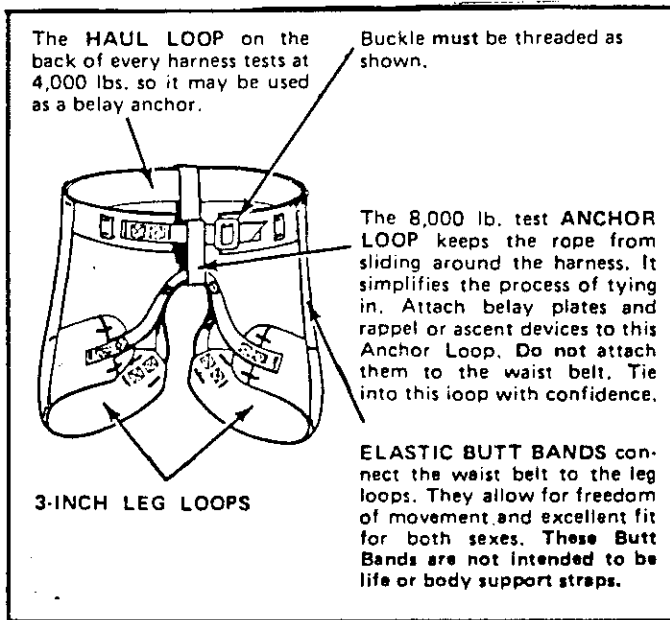

Figure 225 A Commercial Seat Harness

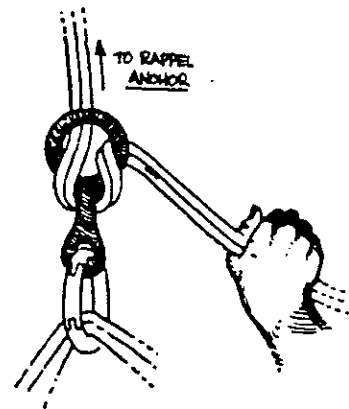

Figure 226 Straight-Figure-8 Descender-Belay Device with the Hook-Up From the Rappel Seat to the Rappel Rope

CHEST HARNESES

Chest harnesses may be used with or without a seat harness. These too, may be improvised or purchased commercially. For beginners, a good way to harness up would be with both a seat and chest harness. Adjustable commercial chest harnesses are shown in Figures 227 and 228.

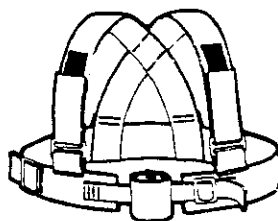

Figure 227 Commercial Adjustable Chest Harness

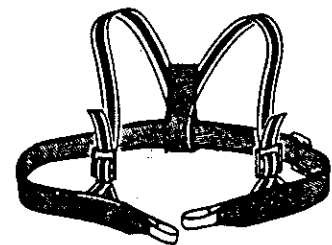

Figure 228 Commercial Adjustable Chest Harness

If you wish to improvise a chest harness, a couple of methods are shown in Figures 229 and 230. Chest harnesses, like seat harnesses, may be made of rope or webbing.

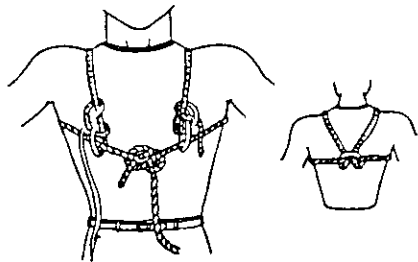

Figure 229 An Improvised Chest Harness Using Webbing or 3/8" Nylon or Manila Rope

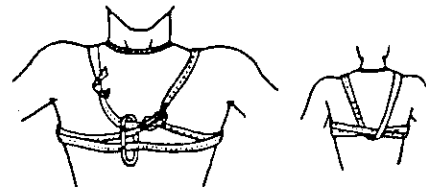

Figure 230 Another Method of Improvising a Chest Harness Using 3/8" Manila or Nylon Rope or Webbing

CLIMBING AND RAPPELLING WALLS

In order to have more fun and better activities, it is often beneficial to offer low key climbing and rappelling programs for beginners. An inexpensive wall can be built very reasonable if patterned somewhat like the ones seen in Figures 231 and 232. These walls can be used by the beginner to teach various methods of climbing such as tension climbing, belaying, use of the grappling hook and many other activities.

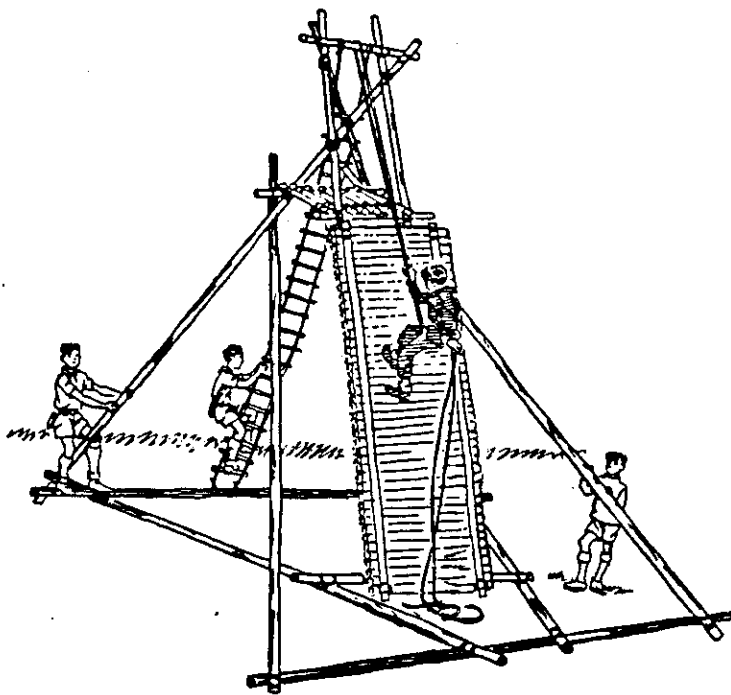

Figure 231 An Easy To Build Beginners Climbing or Rappelling Wall

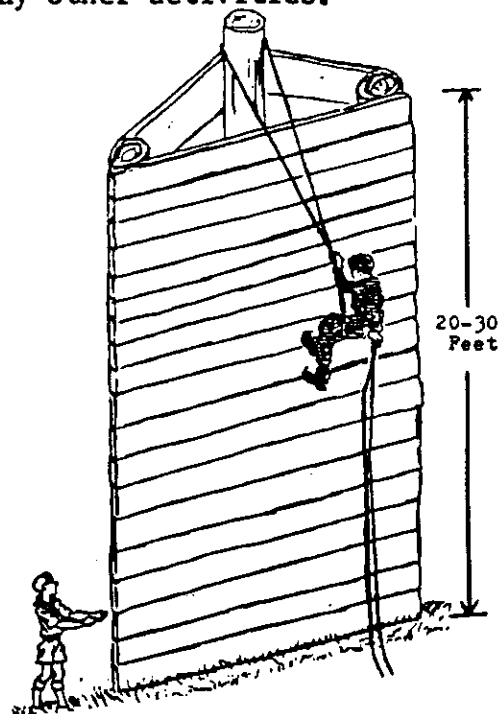

Figure 232 Another Easy To Build Vertical Climbing or Rappelling Wall

TENSION CLIMBING

As an example, if 3/8 inch eye bolts are set into a wall with the bolts spaced from 3 to 4 feet above each other as shown in Figure 233, this can make an excellent exercise in tension climbing. The eye bolts would represent imbedded pitons. Tension climbing is a method of climbing with the aid of seat harness, pitons, snaplinks, aid slings or etriers and a daisy chain or safety rope.

If we were to climb a wall of this type, we would first have to reach up as far as possible and drive a piton into the wall. This piton would be represented by the eye bolt which has already been placed into the wall. A carabiner snaplink is then snapped into the eye bolt (or piton). Two snaplinks with an etrier on each snaplink would be inserted into the snaplink which is suspended from the eye bolt. A daisy chain is then attached to your safety harness and the other end is snaplinked into the piton snaplink leaving as little slack in the daisy chain as possible. The daisy chain acts as a safety line. Then the climber has to climb up the steps of the etrier as high as he can and another piton is driven into the wall. This piton is again represented by the second eye bolt which has

been previously put in the wall. Another snaplink is put into the second eye bolt and the snaplink holding the daisy chain is unsnapped from the bottom eye bolt and is moved up to the snaplink on the next eye bolt. The snaplinks with the etriers are then moved up, one at a time, to the next eye bolt. The climb on the etriers is again started, the imaginary piton is then driven in at the next level, a snaplink is fastened in and this procedure continues until the top of the wall is reached. The only time that a fall is possible is when you move the daisy chain from one level to the next. Take care not to get the daisy chain snaplink between the snaplinks holding the etriers. If this is done, it is difficult to get it free because of the body weight on the etriers.

In the event you were climbing a rock wall in this manner, without a belay from the top, you could be belayed from the bottom. This is done by running a safety or belay line from the belayer below to the climber. As the climber climbs from one piton to the next he inserts the safety rope into the snaplink of each piton. In the event a piton would pull out of the wall, the climber would be held by the previous piton and belayer.

USE OF THE GRAPPLING HOOK

With the same wall, fundamentals of the grappling hook may be taught and used. An improvised grappling hook fixed to the end of a rope may be

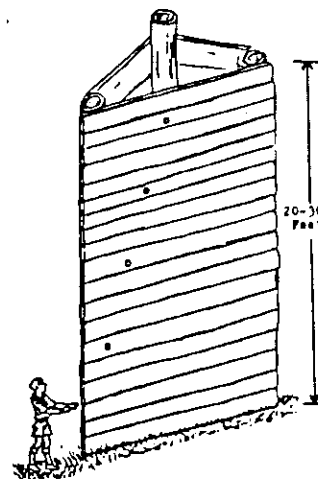

Figure 233 A Rappel Wall With 3/8" Eye Bolts Simulating Pitons Used For Tension Climbing

thrown up over the wall so that the hook will catch on to an appropriate crosspiece. This makes an excellent program for young people. These are "fun" activities. See Figure 234 which shows one method of climbing a vertical wall by using a grappling hook.

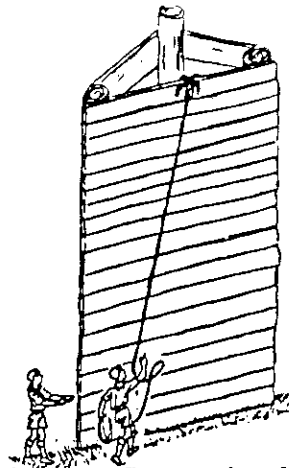

Figure 234 Using an Improved Grappling Hook To Climb A Vertical Wall

INTRODUCTION TO BELAYING

When starting to do smaller climbs, it is necessary to start out by belaying climbers and rappellers. Belaying may also be taught on this type of wall. Belaying is the term used to secure or be secured with a rope against a possible fall by a climber or equipment.

There are several types of belays. Two of the most popular types are the static belay and the dynamic belay. In the static belay, the belayer applies the braking action with utmost speed allowing the absolute minimum of rope to run through his hands. When applied, it creates sudden and sharp halts.

In the dynamic belay, the belayer allows the rope to run through his hands gradually bringing his climber or cargo to a gradual and gentle halt.

When one person is climbing, he is usually belayed from above or below by one or two persons. The belayer is the one responsible for securing the rope against a possible fall by the climber, who is the one being belayed. If the belayer is situated above the climber, it is called an upper belay, and if the belayer is below the climber, it is called a lower belay.

In a lower belay, the belay rope may go directly up to the climber or in some cases, the rope may go from the belayer below, to above the climber, to a belay point and then back down to the climber as seen in Figure 235.

Some of the general rules for belaying are as follows:

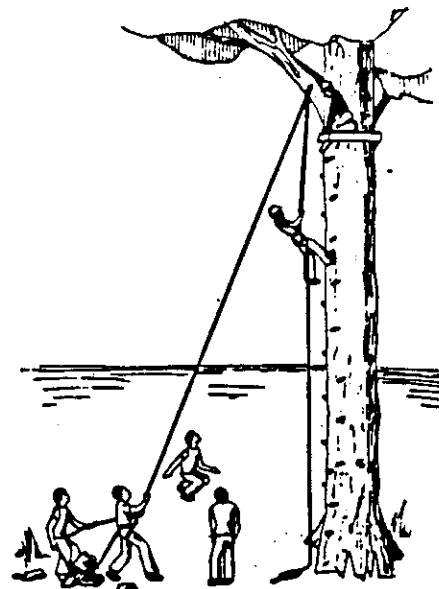

Figure 235 Belaying a Climber Rappelling Down a Large Tree Trunk With a Lower Belay

1. The climber should wear a body harness.
2. The rope is run through the belayer's guide hand. This is the hand which is on the rope running to the climber. The rope then goes around the back of the body to the braking hand, making certain that the rope will slide easily.
3. The belayer must assume a comfortable position.
4. He must then anchor himself to a tree or rock, etc., with a portion of the climbing rope.
5. The belay rope should not run over sharp edges.
6. The belayer must avoid allowing too much slack to develop in the rope through constant use of the guide hand, except where the hand is used as a brace.
7. He must also be very gentle with the line running to the climber so as not to throw the climber off balance.
8. He must try to sense the movements of the climber and try to avoid taking up slack too suddenly as this may throw the climber off balance.
9. The belayer must always keep himself well balanced for the expected direction of fall.
10. In case of a fall, the guide hand is relaxed. Let the rope slide enough so that the braking action is applied gradually for a dynamic belay.
11. If possible, the belayer should be positioned in a direct line between the anchor and the direction of the climber's potential fall to avoid being jerked from a solid belay position. For this reason too, the belayer should be as close to his anchor as possible.
12. The webbing or rope between the belayer and his anchor should be kept taut. Often times, it is a good idea for the belayer to attach himself to an anchor point by fixing a taut line from his seat harness to the anchor point.

BELAYING DEVICES

There are several types of belaying devices, such as the stitch belay plate, the spring loaded belay plate and the figure-of-eight descender/belay device. These all work by cinching.

When using the stitch belay plate, a bight of the belay rope is placed through the slot in the plate and clipped into a locking carabiner. This carabiner is snapped into the belayer's seat harness or waist rope. See Figures 236 and 237. In the event of a fall, the belayer moves the free end of the rope sideways, forcing the plate against the carabiner and thus cinching the rope.

The spring loaded stitch belay plate has a heavy spring which holds the plate away from its carabiner resulting in a dynamic belay in light falls. This plate may also be used as a rappelling device. See Figure 238.

The figure-of-eight descending/belay device is shown in Figure 239. The technic for using this device is discussed and pictured in Figure 240.

NOTE: use LOCKING carabiner



Figure 236 Two Types of Stitch Belay Plates

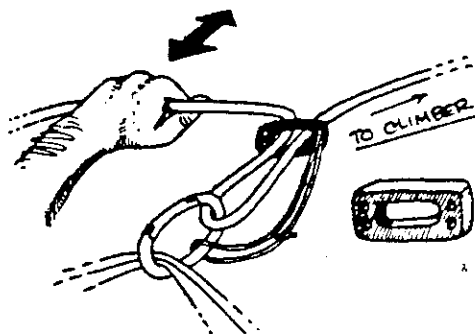

Figure 237 Method of Using the Stitch Belay Plate for Belaying



Figure 238 A Spring-Loaded Stitch Belay Plate (May also be used as a descending device)



Figure 239 Figure-of-Eight Descender/Belay Device

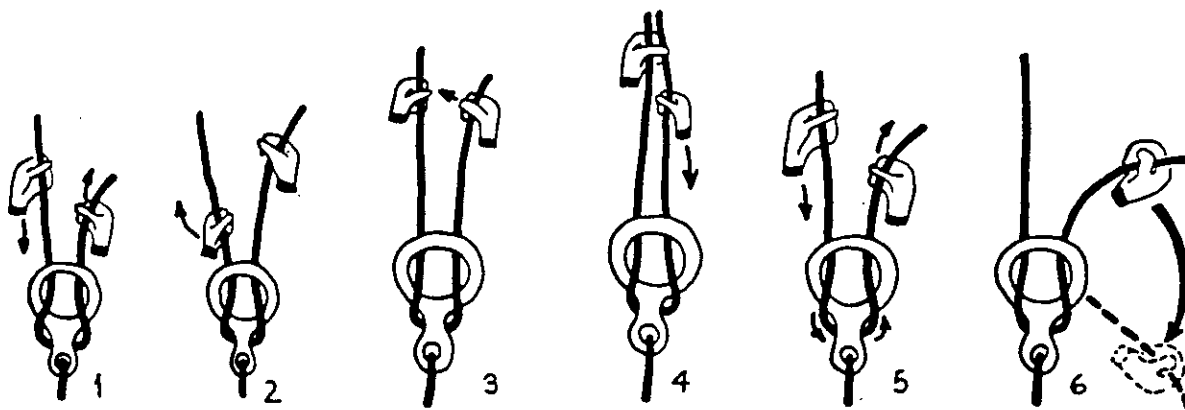

Belaying requires frequent practice with the watchful eye of a qualified instructor to master these motions until they become natural.

When taking up rope, the dominant hand is braking hand, other hand is feeling hand.

1. Pull in rope with both hands on rope until braking hand is fully extended.
2. Hold rope with braking hand and slide feeling hand out.
3. Bring hands together.
4. Hold both parts of rope with feeling hand, slide braking hand toward body, keeping it ready in case of a fall--**NEVER** take braking hand off the rope.
5. Repeat cycle.
6. Holding a fall: Jerking braking hand to the side will increase the friction on the rope in the figure 8 and stop the fall.

Figure 240 Technic of Belaying with a Figure-8 Descender/Belay Plate

THE LOWER BELAY

As stated before, lower belays may go directly up to the climber as in Figure 241, or the belay rope may run from the belayer, below, to above the climber to a belay point and then back down to the climber as seen in Figure 243. The sequence of hook-ups in this type of belay is as follows:

1. The climber should have on a seat and at times, a chest harness depending on the height.
2. The end of the belay rope should be attached to the climber's seat harness with a figure-8-on-a-bight. See Figure 242.
3. The belay rope is then run through a snaplink which is attached to the chest harness if a chest harness is worn.
4. The belay rope then runs upward to some anchor point, such as a locking carabiner snaplink on a cable, as shown in Figure 243.
5. The belay rope then runs through the snaplink and on down to the belayer.

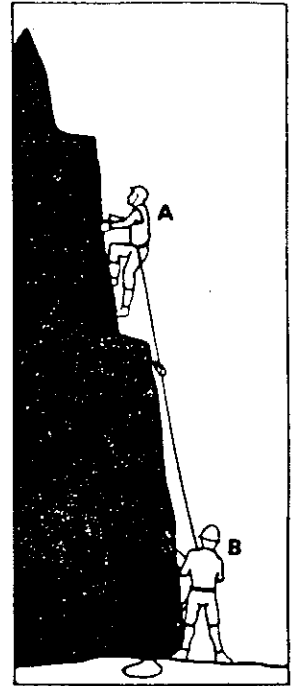

Figure 241 A Lower Belay
If "A" falls, his flight will soon be stopped by "B" because of the imbedded piton and snaplink attachment.

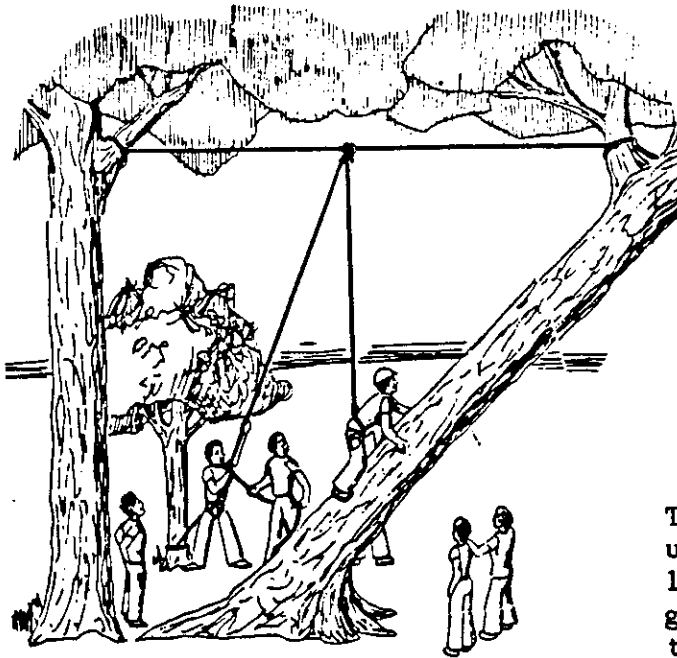

Figure 243 One Method for Anchoring the Belayer



Figure 242 Figure-8-on-a-Bight
or Figure-of-8-Loop Knot

The arrangement in Figure 243 is used between the anchor and the belayer. Also note the second person gripping the belay rope as a "back-up" to the first belayer.

6. A bight of the belay rope is then put through a belay and the loop of the bight is secured into a locking carabiner which is attached to the belayer's seat harness in front. See Figure 237.
7. The belay rope is then handed to a "back-up belayer" or it may be secured between the belayer and the belayer's anchor as shown in Figure 244.

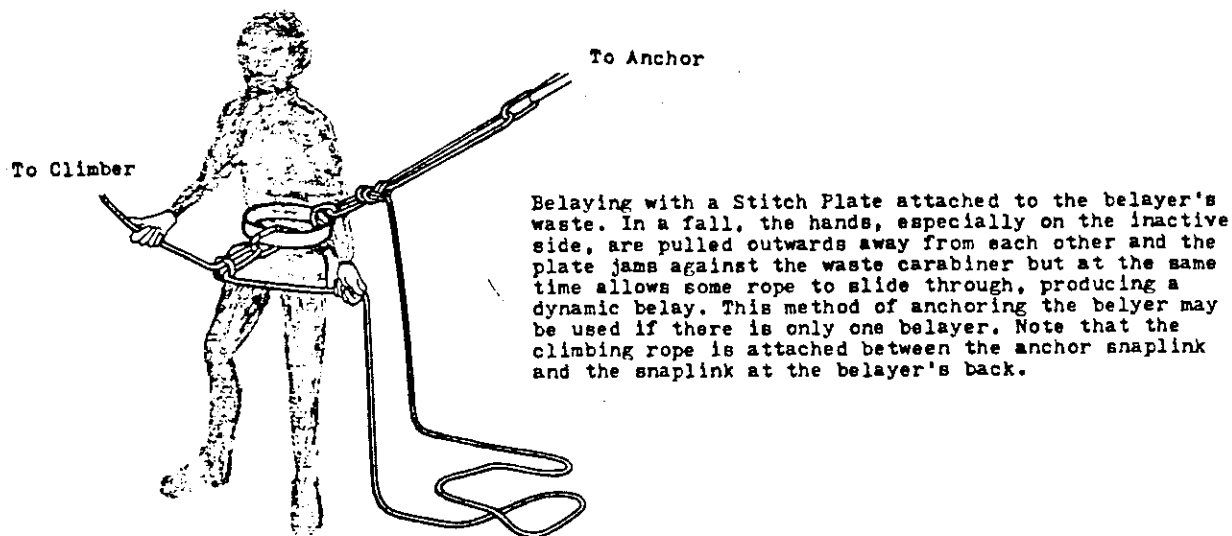

Figure 244 Securing Belay Rope Between the Belayer and Belayer's Anchor

8. The belayer, himself, must be anchored to a permanent anchor, such as a tree. Another method of anchoring the belayer to his own anchor is to place a sling webbing around the anchor and attach it to the back of the belayer's seat harness with a snaplink, as seen in Figure 245.

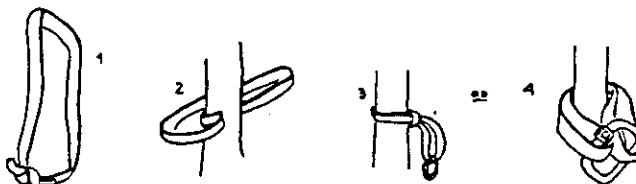

Figure 245 One Type of Anchor for Anchoring the Belayer

The whole operation of belaying must be gone through several times and practiced repeatedly until a nice smooth operation comes to pass. Then you can practice a true belay.

THE UPPER BELAY

Figure 246 shows a sitting position for an upper belay. When giving an upper belay, you can easily hold the weight of a heavier person. The sitting position is the preferred position. Sit down in a good spot with feet apart and firmly braced. Legs should be straight with knees locked.

The rope coming up from the climber is passed around the hips. Both hands hold the rope, one on each side of your body. The hand on the climber's end guides, feels and pulls the rope. The other hand holds the weight in case of a fall. The friction of the rope around the hips makes this surprisingly easy. Take the rope in by moving the guiding hand which is pulling up the rope, toward the body, and extending the brake hand also pulling the rope away from the body. Quickly slide both hands along the rope to their former positions and repeat, but never let the brake hand leave the rope. When using the sitting hip belay, remember the following ten points:



Figure 246 Technic for an Upper (Sitting Hip) Belay

1. Run the rope through your guiding hand (the hand on the rope running to the climber) and around your body to your braking hand, making certain that the rope will slide readily.
2. Make sure that the remainder of the rope is so laid out that it will run freely through your braking hand.
3. See that the rope does not run over the sharp edge of a rock.
4. Use the guiding hand to avoid letting too much slack develop in the rope as the climber moves.
5. Gently tug the line running to the climber to sense his movements.
6. Avoid taking up slack suddenly, since this may throw the climber off balance.
7. Brace well for the expected direction of a fall, so that the force of a fall, whenever possible, will pull you more firmly into position. Neither trust nor assume a belay position that has not been tested.

IN CASE OF A FALL, be able to perform the following movements automatically:

1. Relax your guiding hand.
2. Let the rope slide enough so that braking action is applied gradually by bringing your braking hand slowly across the chest.
3. Hold the belay position, even if this means letting the rope slide several feet.

COMMANDO OR TOGGLE ROPES

The toggle rope or commando rope is a rope with a loop on one end and a wooden or metal "T peg" on the other end. They usually are made of 3/8 inch manila rope and can be of any length from 6 to 12 feet. The wooden peg, or toggle, should be from 4 to 6 inches long and the eye splice on the other end should be only large enough to accept the toggle.

These ropes are good for small groups. If each individual carries one of these ropes they can easily be joined to form a longer rope by placing the toggle of one rope into the eye of the next rope. Figure 247 shows the method of making and using these ropes.

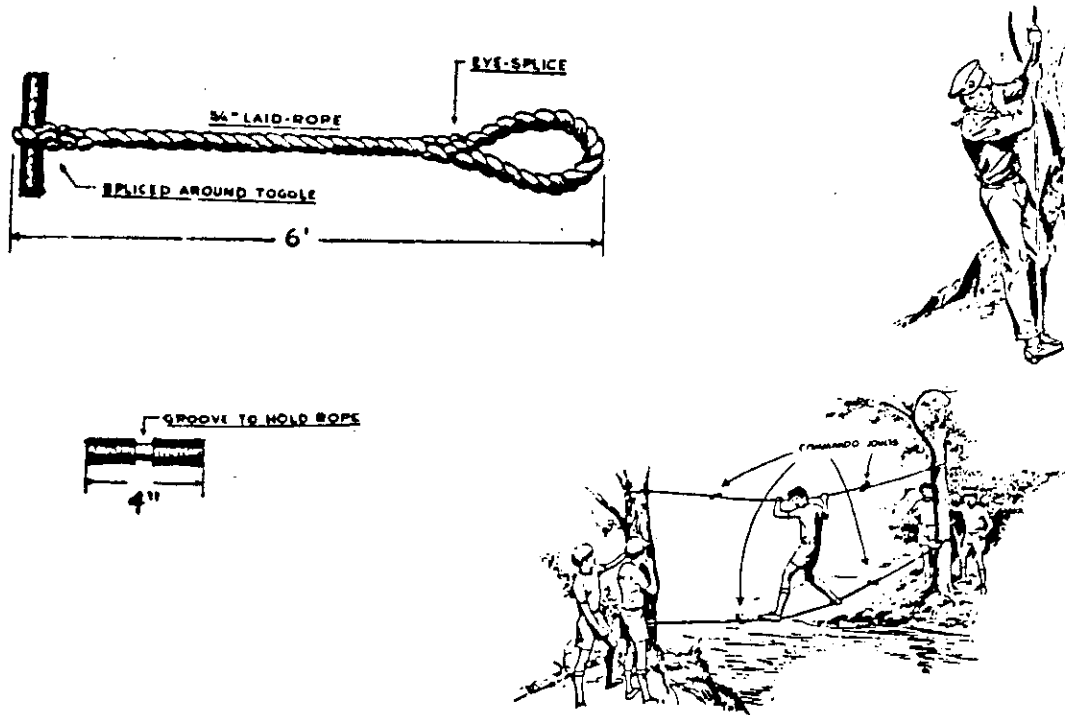

Figure 247 Using the Commando Rope (Toggle Rope)

RESCUE TIES AND TREE EVACUATION

Many good half day programs and activities can emerge from simulated rescues from trees, walls and buildings. We learn that many of the bowline knots are used for rescue work but because of the fact that there are such few rescues, these knots are not used for that purpose very often. It still makes a good learning experience and a good practice exercise to use these knots for mock rescues. If you want a good program, try some of the bowline rescue knots as shown in Figure 248.

Another interesting series of ties is the life basket, shown in Figure 249. The life basket may be used to lower severely injured or unconscious persons.

Tree evacuation is shown in Figure 250. One method of tree evacuation is as follows:

A. Preparation

1. One man climbs the tree taking one end of the rope with him.
2. He passes the rope over the branch of the tree above the position of the casualty.
3. He then ties a bowline on a bight.

B. Lashing the Casualty:

1. Slip one loop over each thigh of the person to be lowered.
2. With same rope tie a butterfly knot around the casualty's chest.

C. Evacuation Procedure:

1. A man on the ground belays the casualty and lowers him from the tree.
2. The climber can also belay the casualty from above by making a round turn around a branch or by using a snaplink above the casualty.
3. Climber escorts the casualty during the descent and prevents his movement from being impeded by intervening limbs and branches.

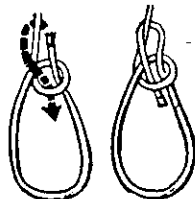

a. The Sailor's Bowline



b. The Three Loop Bowline

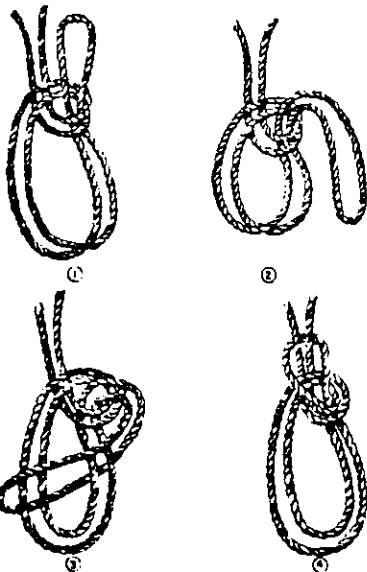

c. The Bowline on a Bight
Also called the Man Sling

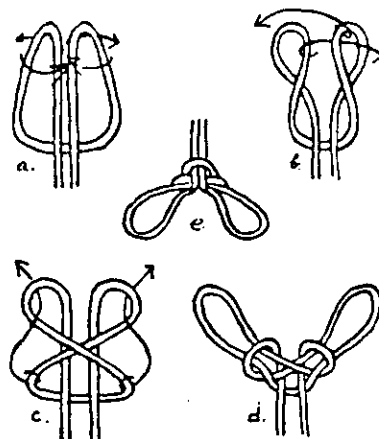

d. Spanish Bowline

Figure 248 The Use of Bowline Knots for Climbing and Rescue Operations

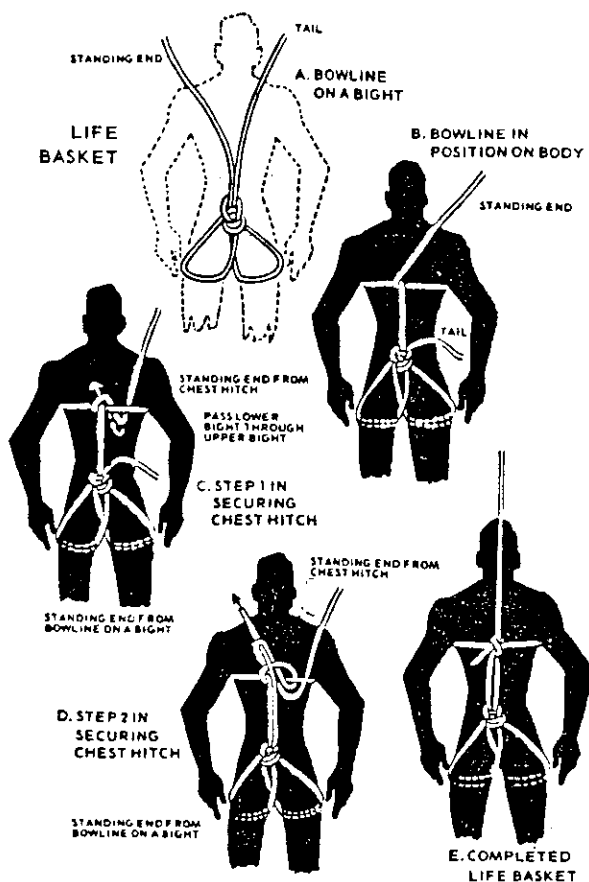

Figure 249 Details for Making a Life Basket for Rescue Operations

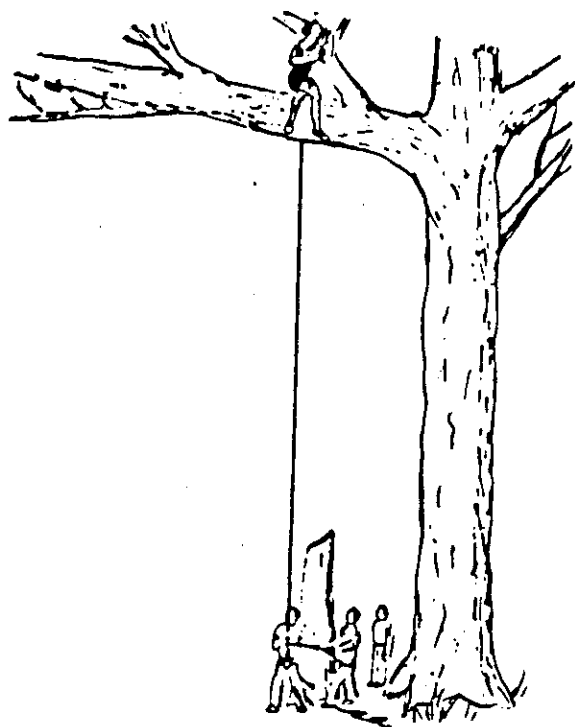

Figure 250 Tree Evacuation

GETTING THE FIRST LINE ACROSS

Most everyone likes a hypothetical problem. How can we get a first line across a ravine or stream without getting into the water? I'm sure one of the easiest ways would be to walk to the nearest bridge. Perhaps a boat or raft would be indicated. Perhaps a tree could be felled across a creek or one tree might be chopped down on either side of a stream so that the two tree trunks would meet near the middle of the stream. I'm sure that a lengthy discussion could be had by a small group on just how we could get a line across a narrow river without getting our feet wet. See Figure 251.

A good line across a river might be used as a hauling line or construction line for getting tools and other supplies across in order to build a semi-permanent bridge. This type of horizontal traverse could also be used for getting equipment or personnel



Figure 251 How to Get a "First Line" Across a Creek

across or it may be used for a simple one rope bridge, or a forerunner to a two or three rope bridge.

A horizontal suspension traverse is any rope installation used to bridge ravines, rivers, creeks or streams, or it could be used to bridge hypothetical gorges, chasms or canals.

There are many ways that a first line can be secured across a stream. Some of these methods could be using a kickbridge, a shear movement, a grappling stick, a grappling hook, or using a stout pole and the "Y" of a tree.

THE KICKBRIDGE

Assuming that you want to use a kickbridge (Figure 252) to cross a shallow stream that is approximately 15 to 18 feet across, you would need the following equipment and personnel:

1. Two 10 foot poles with a 3 inch butt
2. Seven 1/4 inch ropes that are approximately 25 feet long
3. Several people to do the job

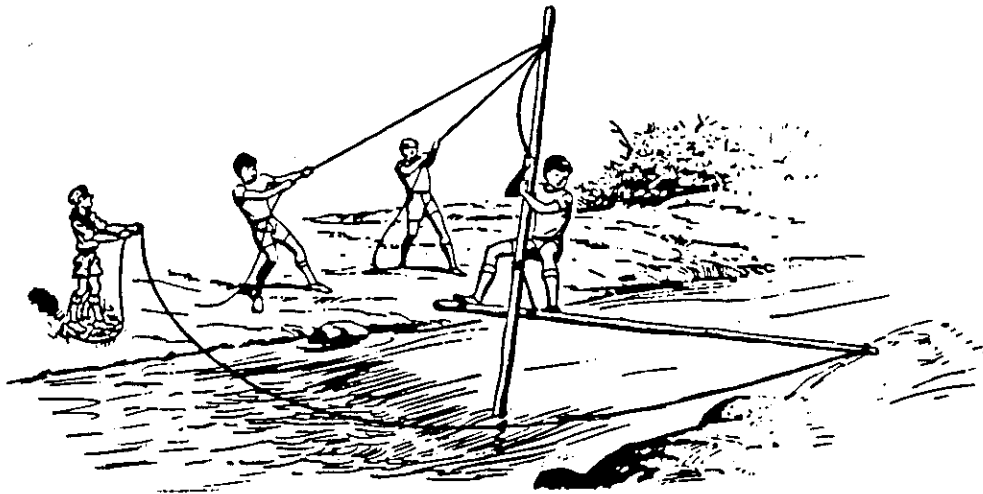

Figure 252 The Kickbridge

One pole will have to be the upright and the other pole the boom. Attach the boom pole to the upright high enough so that the boom will clear the top of the water. The boom will also have to be attached loose enough so that it will swing freely around the upright. If the knot on the upright has a tendency to slip down with the weight of a person and the boom, one can always put in an eye bolt or a dowel etc., and this can be used to insure that the knot on the upright will stay secure.

The ends of five of the remaining six ropes are all tied to the top end of the upright as close to the end as possible. The unattached ends are each held by one of the individuals. The remaining rope end

is tied to the end of the boom pole so that the boom can be brought back across the creek after each crossover. Each person now grips the free end of one of the ropes. They must now fan out holding their ropes loosely while another person raises the upright and maneuvers it into the middle of the streams. They must now juggle their guy ropes so that the top of the upright will incline towards the opposite bank. The first person is now ready to cross.

Taking the guy rope, holding it taut and using it as a balancing guide, he walks out on the boom pole to the upright. He then maneuvers the boom pole with his feet around the upright to the opposite bank. Still using the guy rope as a balancing guide he walks the boom pole to the opposite bank and continues to hold on to his guy rope. The boom is then brought back to the near side by pulling the boom line. The second person now follows the first and so on.

Before the last two or three people cross over it will be necessary for the group on the far side to fan out with their guy ropes while the smaller group on the near side tilt the upright in the opposite direction so that the vertical upright leans in the direction of the group who must yet cross over the stream. The group on the far side of the stream will then be in charge of holding the upright. The two or three remaining may now cross the stream in the same manner as the first group except that the upright is tilted in the opposite direction.

This exercise makes an excellent program in teamwork whether they are actually crossing a stream or if they are just crossing an area of "lethal shin-high radiation."

THE SHEAR LEG MOVEMENT

The shear leg movement or just plain shear movement is quite easy to understand by the drawing in Figure 253. It is primarily designed to get just one person across the stream. The two poles which are used for the uprights must be long enough so that the location of the seat will reach each bank when the shear legs are in the middle of the stream. It will take 2 or 3 husky people to hold the shear leg structure while the smallest person gets on to the seat and is then hoisted to vertex. It will take another 2 or 3 husky people to hold the shear leg structure from falling too fast toward the opposite bank after the rider has been pushed to the apex.

Like the kickbridge, the shear movement is another good exercise in teamwork and trust. It also makes a good problem for developing leadership, communications and problem solving.

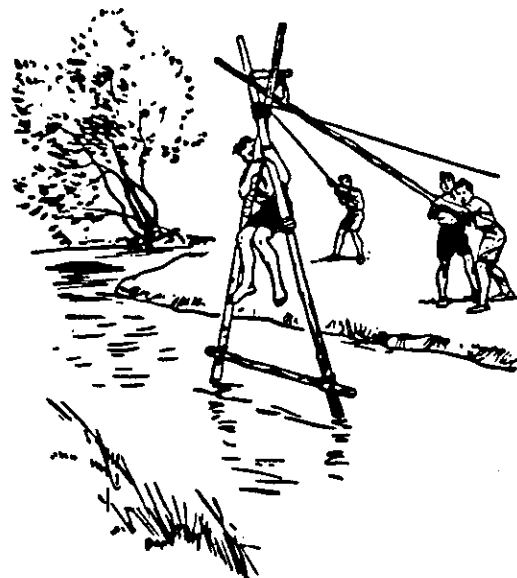

Figure 253 Shear Leg Movement

THE GRAPPLING STICK

This makes another good problem for a small group and it can be used practically for getting a first line across a stream or, if desired, a hypothetical chasm. It sharpens the wits in problem solving and helps to build personal pride when the problem is completed. See Figure 254.

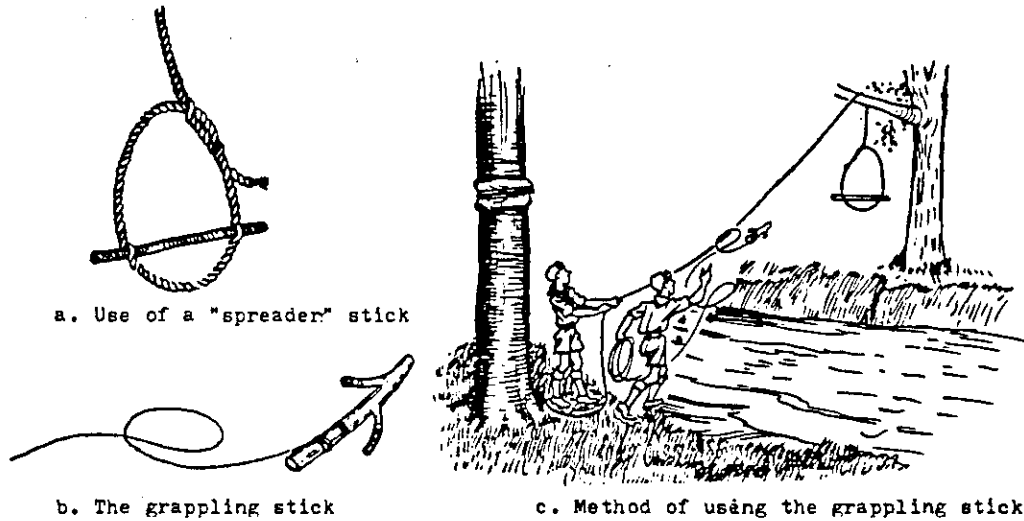

Figure 254 Using a Grappling Stick to Get a First Line Across for a One Rope Bridge

This makes an excellent method of getting a first line across if you can throw the end of a $\frac{3}{8}$ inch or $\frac{1}{2}$ inch rope over a hardy branch or limb of a tree that is on the opposite bank of a creek. First, a loop is placed in the end of the rope to be thrown over. The loop is held open with a "spreader" stick as shown in Figure 254-A. After the loop has been thrown over the limb, a grappling stick (shown in Figure 254-B) is fastened to a long twine or small cord and thrown through the loop. Then by pulling the cord or twine back, one of the small branch stems of the grappling stick should catch the loop so that the large rope may be brought back. The doubled rope may then be tied off on the near side of the creek on another tree and the line is then ready to be traversed. One of the methods of traversing a rope is the tyrolean traverse seen in Figure 255.

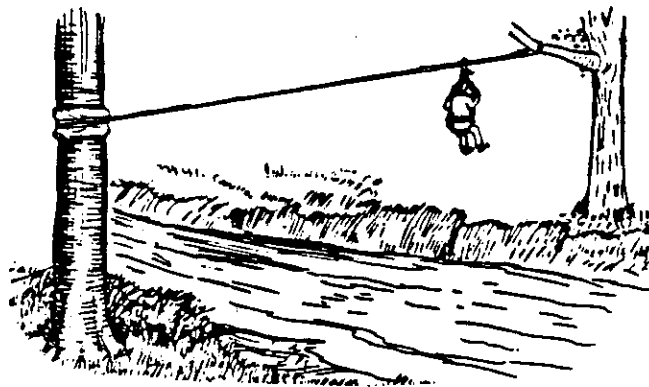

Figure 255 Using a Tyrolean Traverse on a One Rope Bridge

THE GRAPPLING HOOK

Once again, if there is an appropriate tree on the opposite bank, one can use an improvised grappling hook to get a first line across. Grappling hooks are difficult to find on the market, but they can be home-made quite easily. One method of making a grappling hook is to use five $7/16$ to $1/2$ inch metal rods, each 13 inches long. The rods would be pointed on one end with the pointed ends turned back so they resemble a large fish hook. The shafts of the rods are then spaced equally apart and welded together with a large eye screw placed in the center of the five rods at the top for the rope attachment. A $1/2$ inch rope is attached to the grappling hook with an eye splice and then it is thrown and anchored in the crotch of a tree on the opposite bank. The free end can then be anchored on the near side of the creek or some suitable tree. The rope should be as taut as possible. It is then ready to be traversed. See Figure 256. Figure 257 demonstrates the British crawl on a rope.

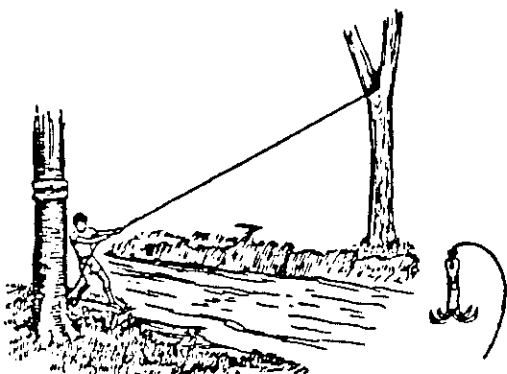

Figure 256 Using a Grappling Hook to Get a First Line Across

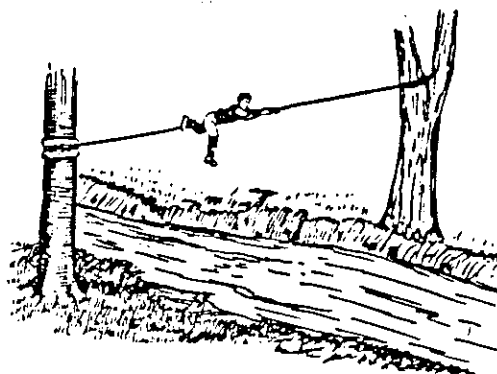

Figure 257 Using the British Crawl

A POLE AND A TREE "Y"

Still another method of getting a first line across a narrow stream, providing appropriate trees are at hand, would be to use a short stout pole and the "Y" of a tree. This is illustrated in Figures 258 and 259.

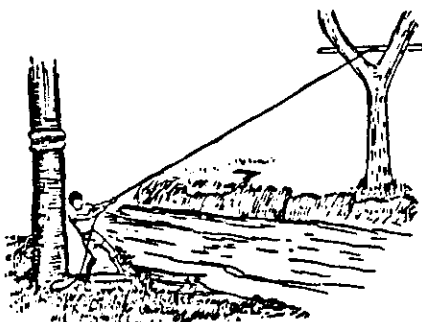

Figure 258 Using a Pole and Tree "Y" to get a First Line Across

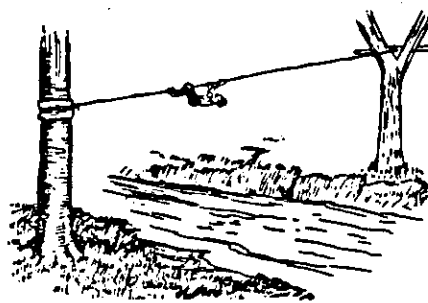

Figure 259 Using the American Crawl to Cross a One Rope Bridge

A 3/8 or 1/2 inch rope is tied around the middle of a stout 3 foot long pole which can be tossed across the stream into the crotch of a tree. When it is securely anchored, the opposite end would have to be tied off on the near side of the stream at about the same height as the pole in the crotch of the tree. The line can be made tight with one of the appropriate tightening arrangements and the rope would then be ready for traversing. Figure 259 demonstrates the American crawl on a rope.

TRAVERSING A ROPE

One rope across a ravine or creek could be used as a construction line, hauling line or a horizontal traverse. It could also be used as a one rope bridge if there wasn't going to be too much traffic. There are several ways to traverse a single rope bridge. Seven good methods are listed here and are shown in Figure 260.

1. The British Crawl
2. The American Crawl
3. The Tyrolean Traverse
4. The Step-Slide
5. The Pulley Arrangement
6. The Aerial Runway
7. The Cableway

THE BRITISH CRAWL

The person to cross a one rope traversing line lies on top of the rope with the left instep hooked on the rope with the left knee bent, and the right leg hanging down straight for balance. After assuming this position, the crosser pulls himself across the rope with his hands and arms. He may also push with his left ankle. This method is fairly easy and you can always rest at any time. After doing this method a few times it becomes the method of choice between the British and American Crawl. See Figure 260-A.

THE AMERICAN CRAWL

The American crawl is shown in Figure 260-B. This is a method of crossing a heavy rope or cable in which the body is under the rope rather than on top of it. The rope is grasped with both hands and the feet are kicked up over the rope so that the back of one ankle rests on top of the other ankle which is holding on to the rope. Then the body is moved headward across the rope by walking the hands and arms across the rope and holding the body up by way of the locked ankles. If desired, the ankles may be walked along the top of the rope in conjunction with the arms.

THE TYROLEAN TRAVERSE

The Tyrolean traverse is a method of traversing a horizontal rope by means of an improvised sling seat which is attached to a snaplink.

The snaplink is then attached to the rope to be crossed and the crosser is then hanging by his hands and a snaplink. He then pulls himself across with hands and arms while keeping his legs together and back slightly arched. The sling seat may be an improvised seat harness, a Spanish Bowline, a two loop bowline or any other improvised seat. This traverse is seen in Figure 260-C.

THE STEP-SLIDE

The step-slide (Figure 260-D) is a method of crossing one rope with two 1/4 or 3/8 inch ropes from 7 to 10 feet long, depending on the size of the individual. A bowline is tied in each end of the two ropes allowing the loop to be large enough so that the feet can be placed comfortably into each loop. On the other end of each of the two ropes tie a figure-of-eight-on-a-bight (Figure 242) so that this knot is about shoulder high when your feet are in the bowline loops. A snaplink is attached to the figure-of-eight loop and then on to the horizontal rope.

One foot goes into each stirrup and each hand is placed on the lower half of the snaplinks. Assuming that you want to go to the left, your weight is shifted to your right side and right foot. With your left hand, you move the snaplink to the left and then shift your weight to the left foot and at the same time bringing your right hand with the snaplink to meet the one in the left hand. This procedure is duplicated until the crossing has been negotiated. By this system of weight shifting, stepping and sliding the snaplink, it becomes quite easy to cross a rope or cable.

THE PULLEY ARRANGEMENT

This method of crossing a one rope suspension traverse consists of using a single sheave snatch block which is attached to a boatswain's chair, man sling knot or a Spanish bowline. The seat apparatus is then attached to a "pull line" so the rider on the seat may be pulled back and forth. See Figure 260-E.

The best type of block to use is a single sheave snatch block with an eye. The snatch block, with its opening in the face, allows the block to be put on and taken off a fixed rope after the rope or cable has been strung across the desired terrain or water. If you use another type of block it would have to be threaded on to the rope or cable before the traverse line is secured and tightened.

THE BOATSWAIN'S CHAIR

This is also called a bosun's chair. It is a very understandable piece of equipment, easy to build and fun to use. Usually, a Spanish bowline or man sling may be used in place of a bosun's chair, but the true bosun is a wooden seat suspended by ropes. A wooden seat is more comfortable and more convenient than a rope seat.

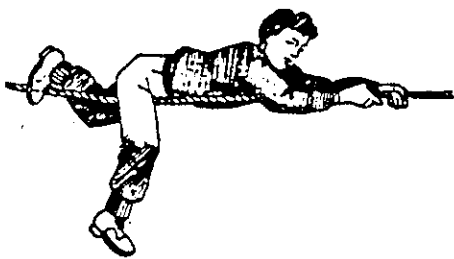

A. The British Crawl

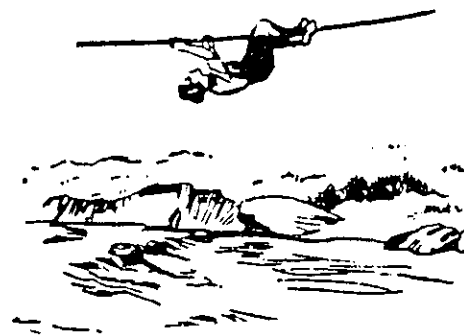

B. The American Crawl



C. The Tyrolean Traverse

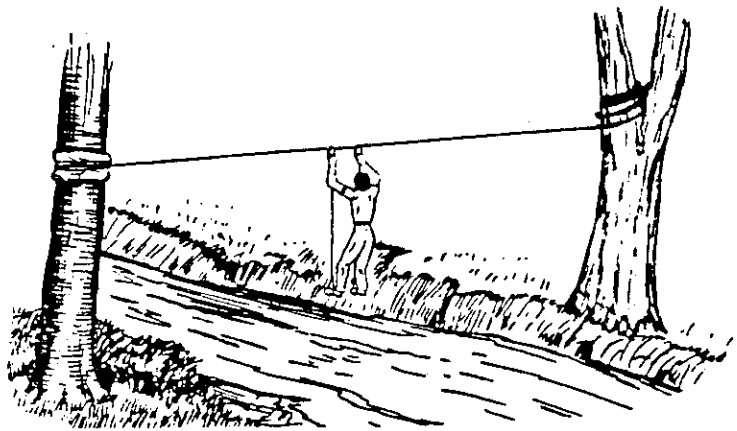

D. The Step-Slide

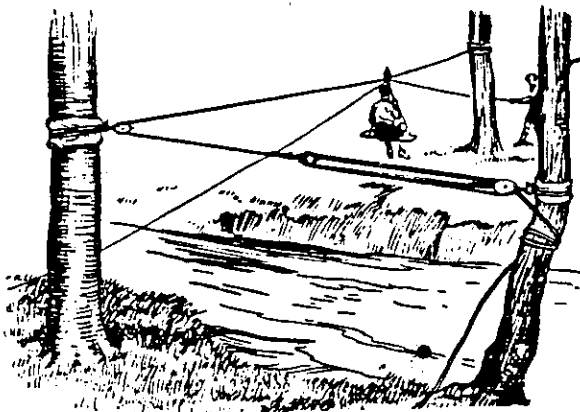

E. Using A Pulley Arrangement

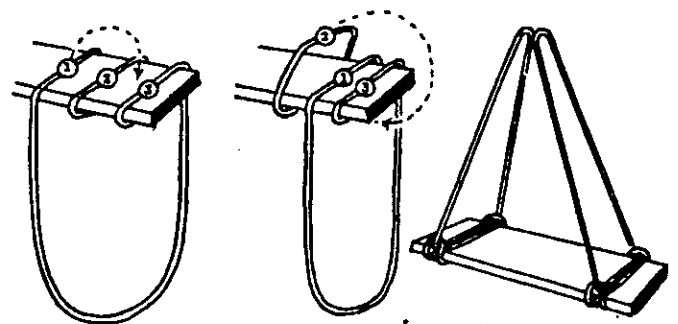

F. Using A Scaffold Hitch to Make A Boatswain's Chair

Figure 260

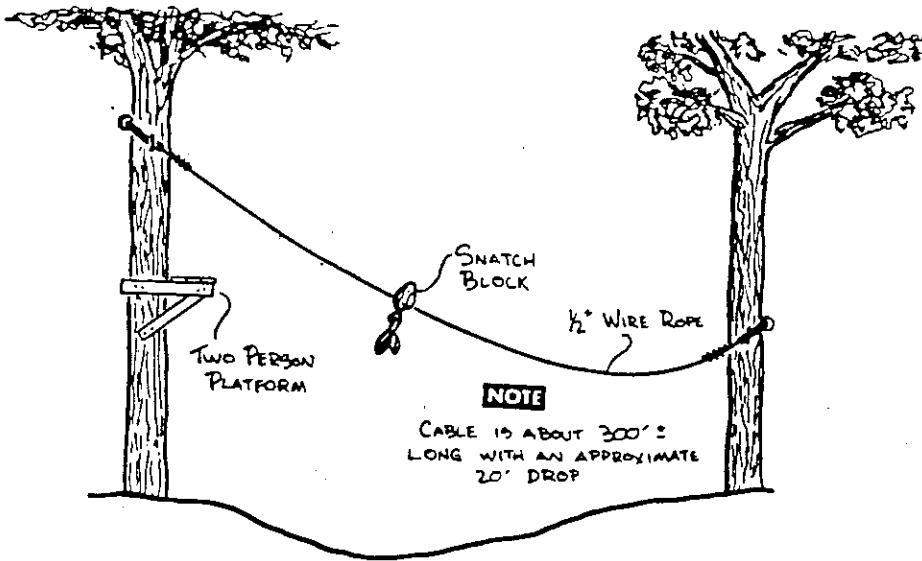

G. The Aerial Runway



Note the pull back rope and the non snatch block

H. The Seat Method of Traversing

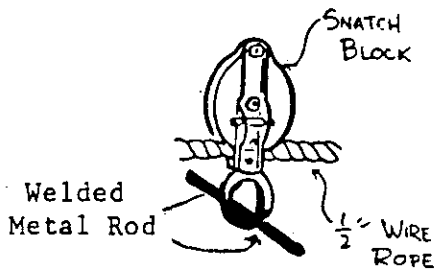

I. The Block and Rod Method of Traversing

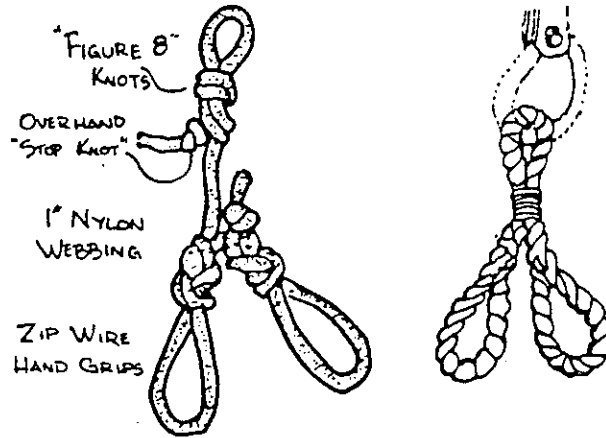

J. The Hand Loop Method of Traversing

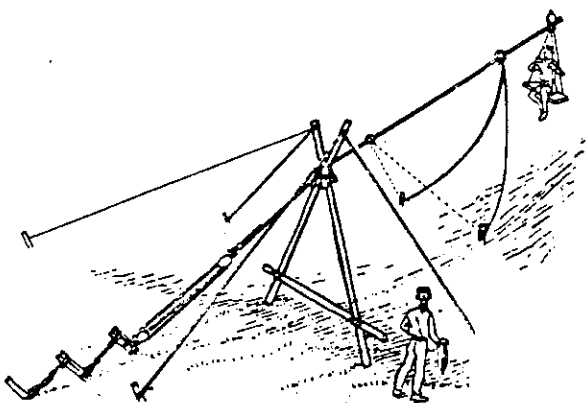

K. A Brake System for an Aerial Runway

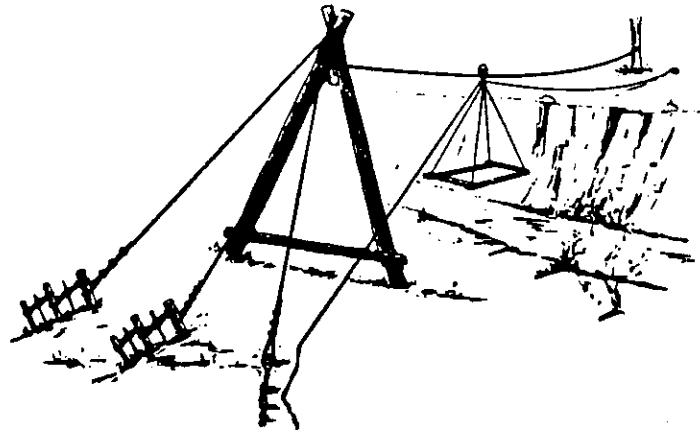

L. The Cableway

Figure 260 (Continued)

One method of making a boatswain's chair is to use a scaffold hitch. To start, make two strops from two 15 foot lengths of rope 3/8 inch in diameter. If need be the strops can be improvised on the spot with fisherman's knots. The seat board should be about 24 inches long by 10 inches wide by 1 inch thick. Personally we have never known the scaffold hitch to fail, but in preparing your board it is a good idea to cut notches in the sides about 4 inches from the end to give the strops something to bite into.

To make the scaffold hitch, Figure 260-F, open the strop and lay three turns across the end of the board. Lift the inside turn (No. 1) over its neighbor (No. 2), then lift No. 2 and pass it over Nos. 1 and 3 and over the end of the board. Raise the belly of the strop over the end of the board and work the hitch into the notch as necessary. Repeat the process at the other end of the board, then bring up both strops together and make them fast by whatever method seems appropriate in the circumstances.

THE AERIAL RUNWAY

The aerial runway is sometimes referred to as a "zip wire." This is the "fun" one. It is closely associated with the horizontal pulley arrangement and the boatswain's chair. The aerial runway is a ride through the air on an inclined cable or rope via a single sheave block and an attached hand grip or seat. The suspension rope, if used, should be 3/4 inch rope. Better than rope would be 3/8 inch wire rope or cable.

The rope cable can be fastened to a high tree and then run to a lower tree as in Figure 260-G. It works especially well if a tree is on a high bank on one side of a creek and the traverse line runs across the creek to another tree on a lower bank of the creek.

A single sheave self-locking snatch block with an eye is ideal for the runway because it can be opened up and put on, or taken off, the cable as in the pulley arrangement. To open a self-locking block of this type, the hook or eye must be turned down parallel to the shell before the link will open. If a snatch block is not used, a "pull back" line would have to be attached to the becket of the block so it could be pulled back and forth.

A boatswain's chair can be suspended from the eye of the block for the passenger to sit on as seen in Figure 260-H. If desired, a 3/4 inch metal rod about 8 to 10 inches long could be welded horizontally across the eye or hook of the block and the rider could hang on to these handles as he rode down the runway. See Figure 260-I. Still another method would be to get a piece of webbing or rope and tie hand loops to hang on to as in Figure 260-J.

Then a method of stopping or slowing down must be provided. There are many ways this can be done. One approach might be to have the traverse cable just loose enough so that the weight of the body on the chair causes it to sag just before it reaches the tie off point on the far side as shown back in Figure 260-G.

Another brake method might be to use a fairly long anchor rope with a running loop ring or figure-of-8 loop knot tied in the middle of the anchor rope with the loop around the traverse line. Near the spot where you would like to stop, the two ends of the anchor line would be tied to stout pickets or some other type of anchor. These stakes would then be anchored on each side of the runway line as in Figure 260-K. When the traveling block hits the loop, the friction of the rope on the loop will exercise some braking effect before the seat comes to a halt. This stopping method may create a forward momentum to the seat so all passengers should be made aware of this fact.

THE CABLEWAY

In general, the components of a cableway system include 2 blocks, a traverse rope or cable supported at each end, with a carriage of some sort pulled along the rope, cable or track by a "haul rope."

A cableway (Figure 260-L) is used to cross a stream or single depression that would otherwise be difficult to traverse. A cableway of this type can be used for either personnel or equipment. A carriage can be attached to the traverse line by two single sheave blocks.

Technically, a tramway is used the same way as a cableway, except that a tramway requires intermittent towers to hold up the traverse rope or cable. This makes it possible to traverse a series of depression or abrupt changes in slope:

THE TWO-ROPE COMMANDO BRIDGE

After a first line across has been established, a two-rope bridge can be constructed by securing another line either above or below the first rope so that the ropes are approximately 4 to 5½ feet apart. See Figure 261. If desired, one or more spreaders may be used to prevent spreading between the two ropes. Usually this is indicated when longer spans are traversed. Spreaders are ropes placed perpendicular between the two ropes which are spanning the creek. They can be tied off at top and bottom with a round turn and two half hitches. If cable is used, the suspenders may be fastened with a "U" bolt clamp.

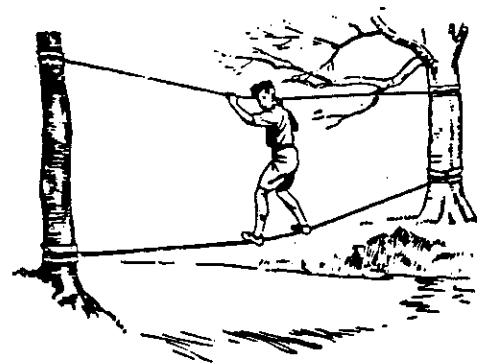

Figure 261 A Two-Rope Commando Bridge

A rappel seat of some type may have to be utilized in order to fasten the spreader ropes if they are deemed necessary.

To cross a commando bridge, grip the top rope with both hands, place feet on the lower rope and sidestep across. Again, if desired, a safety harness may be worn with a snaplink attachment to the top rope.

THE LAZY MAN'S ROPE BRIDGE

Figure 262-A shows a picture of another type of two rope bridge which is inefficient, impractical and more or less useless. However, it is a structure that a group can have fun making and crossing, or it can be quite effective in a "follow the leader" type trail. This bridge is made primarily for fun. An easier way of crossing two ropes suspended in this manner would be to use the "kitten crawl" as shown in Figure 262-B.

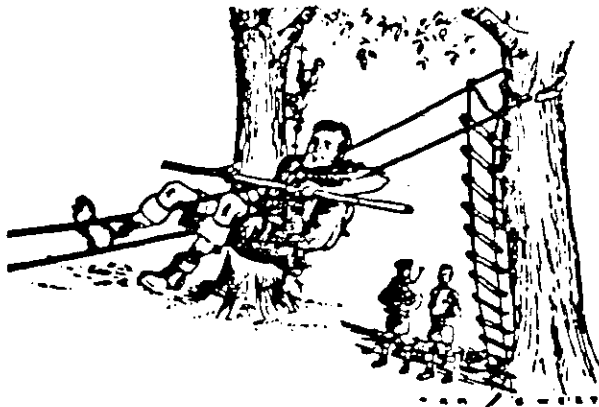

Figure 262-A Lazy Man's Two Rope Bridge

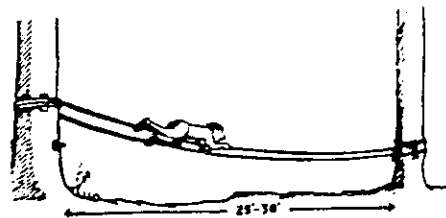

Figure 262-B The Kitten Crawl

THE THREE ROPE MONKEY BRIDGE

A three rope bridge is usually established for a larger volume of traffic than the one or two rope bridges. It can easily span a stream of 35 feet and a lot more if heavier manila rope or cable is used. This type of bridge (Figure 263) may also be used as a fun bridge if left relatively loose. This is one reason that it is called a monkey bridge. Kids can have lots of fun trying to dump their partners into the stream by jumping on, swaying and tugging the ropes trying to get the other one off guard.

However, when tightened, this bridge makes a good bridge for crossing with its foot rope and handrails.

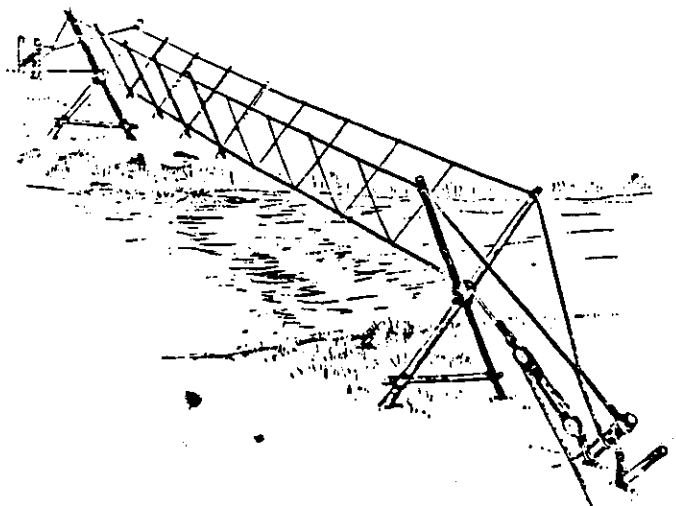

Figure 263 A Three Rope Monkey Bridge

The bridge consists of three main lines known as the handrails and the tread or foot rope. Additional ropes may be used as suspenders if desired. If used, the end of the suspender ropes can be tied on to one of the handrails with a round turn and two half hitches, on around the foot rope with a round turn and then tied off on the opposite handrail with another round turn and two half hitches. If 3/8 inch cable is used, suspenders may be put on with "U" bolt clamps.

CONCLUSION

Rope specialties encompass many many features. A few of them we have gone over in this chapter, but the list goes on and on. Working with ropes can give hours and days of fun. There are so many things that can be learned and so many things that can be done that the list is almost endless. Therefore, when you need a program for a large or small group, one of the vast reservoirs of wealth is in rope specialties.

CHAPTER 8

THE TOPOGRAPHICAL MAP

MAPS

A map is a representation, commonly on a flat surface, of a whole or a part of some area or establishment. More simply, most maps are usually nothing more than a piece of land, such as in Figure 264, as it looks from the air. There are many different kinds of maps. Some of the most popular kinds of maps or charts are listed here:

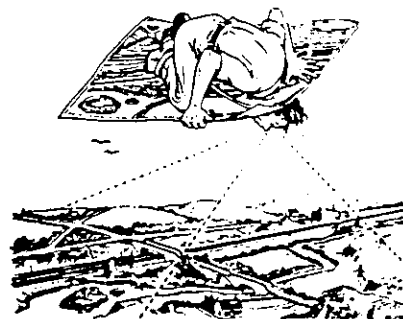

Figure 264 A Map is a Piece of Land As Seen From the Air

1. Globe Maps of the World

The globe maps of the world show the earth's surface as it is in reality. By looking at a globe map you can readily see how difficult it is to make a flat map of the world.

2. Map of the Heavens

This type of map may show the ecliptic or the great circle of the celestial sphere that is the apparent path of the sun among the stars or of the earth as seen from the sun. Or it may show constellations or planets.

3. Aeronautical Charts

These maps are used by airplane pilots for navigation and show flight paths, airports and other related subjects.

4. Navigational Maps

These waterways charts are used by seamen who pilot ships on larger rivers. They show information on mileage, dams, locks, buoys and on-shore topography.

5. Inland Waterway Maps

Maps of this type show the various lakes, portages and trails of inland waterway systems. This type of map is especially valuable in canoe country.

6. Climate Maps

These are maps showing the climate conditions for various areas.

7. Weather Maps

These maps are used chiefly by Weather Bureaus to show the progress and changes in weather conditions.

8. Political-Physical Maps

These maps show the character and elevations of the landscape. On this type of map there is an international agreement on the standard use of colors for certain elevations:

- a. Green - Less than 1000 feet
- b. Yellow - 1000 to 2000 feet
- c. Tan - 2000 to 5000 feet
- d. Orange - 5000 to 10,000 feet
- e. Brown - Over 10,000 feet

9. Relief Maps

Relief maps show the elevation of the terrain in miniature.

10. Aerial Photographs

These maps are aerial photographs of the land. They are used extensively by the Federal and State Departments of Agriculture and Soil Conservation Services.

11. Federal, State and County Road Maps

These maps are designed highways, cities and other physical features.

12. City Maps

Likewise, city maps show streets, buildings, lakes, etc., within the various cities.

13. Thematic Maps

Thematic maps are maps with a special theme, such as geological maps, land use maps, agricultural maps, population maps - to name a few. Some of the above map headings may be classed as thematic maps.

Most thematic maps are based on topographical maps, but in most cases the topography is subdued so as not to interfere with the depiction of the dominant theme of the map.

14. Topographical Maps

These maps show the topography along with other physical features.

THE GLOBE MAP OF THE WORLD

This is probably the best and most accurate map of the earth because the earth is shaped like a ball. It is not possible to draw a flat map of the earth without some kind of squeezing, stretching or tearing. It is like trying to flatten a rubber ball. It will either wrinkle or crack but if only a small area is shown on a map, the error is not important so even though "flat maps" are somewhat distorted, a small flat map of a small area will not have too much distortion. Transferring this curved area of a globe to the flat surface is called "projection." These projections may be taken off a globe in several different ways. See Figure 265.

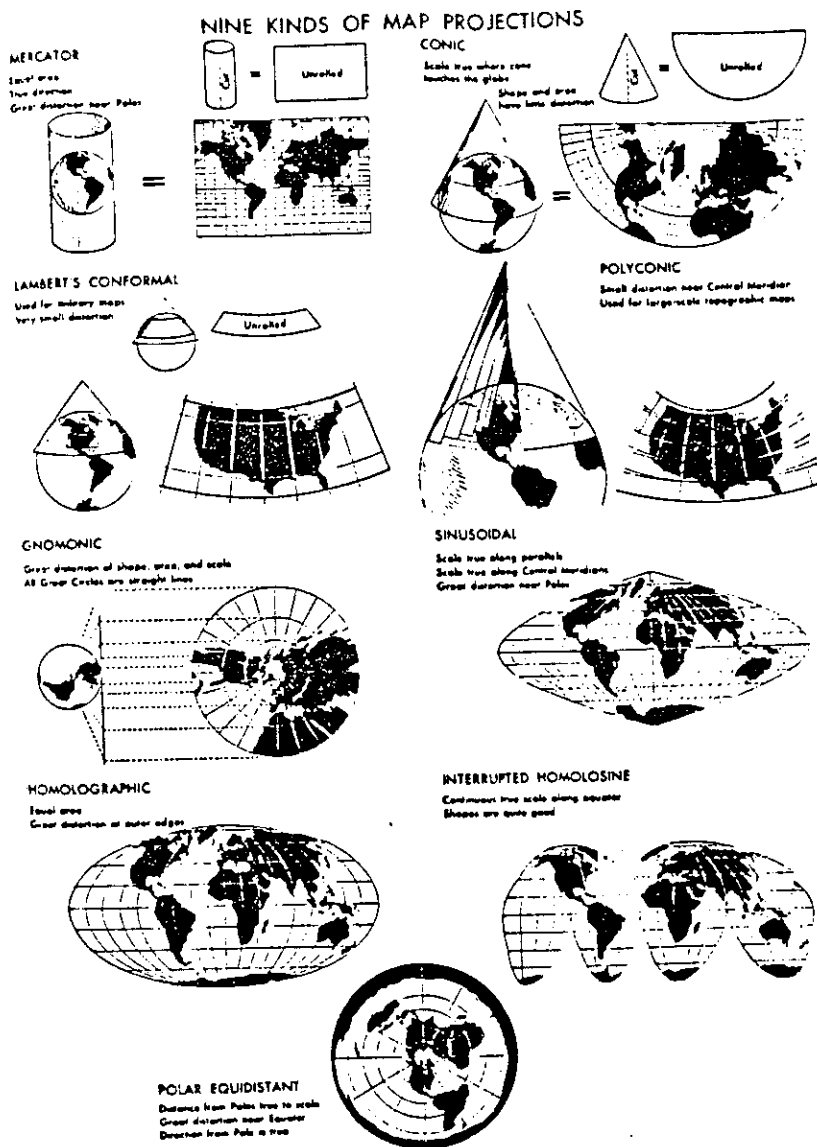

Figure 265 Nine Kinds of Map Projections

The earth is divided into 5 zones as shown in Figure 266. The earth is also divided into parallels of latitude which run horizontally around the earth, the equator dividing the parallels into north and south latitude. Then it is divided into Meridians of Longitude which run vertically around the earth, each Meridian crossing at the two poles. The Prime Meridian running through Greenwich, England, divides the earth into East and West. See Figure 267. The International Date Line is the 180th parallel opposite the Prime Meridian.

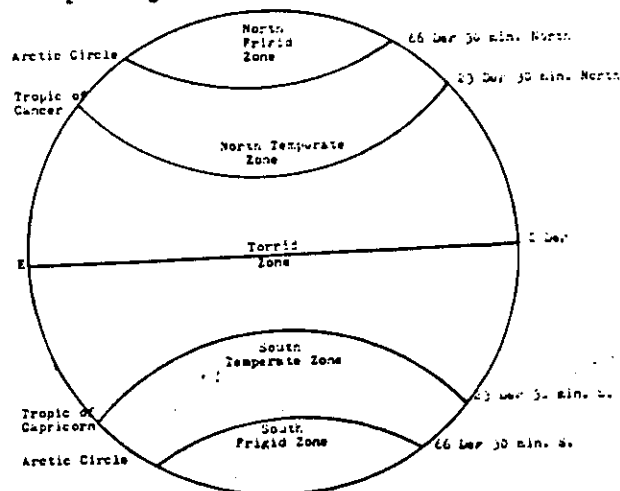

Figure 266 The Five Zones of the Earth With the Latitudinal Divisions of the Earth's Surface

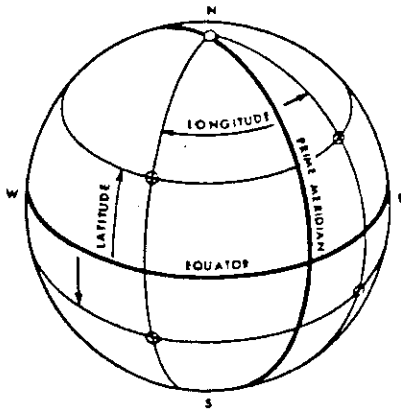

Figure 267 Parallels of Latitude and Meridians of Longitude

The earth is a rough ball with a circumference of about 25,000 miles. Lines of latitude and longitude each number 360 degrees, each degree being subdivided into 60 minutes and each minute being subdivided into 60 seconds. Each degree of latitude is approximately 69 miles. Rochester, Minnesota, is about 44 degrees north of the Equator or about (44×69) 3,036 miles north of the Equator. One minute is equal to about 1.1 miles and each second is about 100 feet. Likewise, a degree of latitude is equal to about 111,000 meters; a minute is equal to about 1850 meters and a second is about 30 meters. For a metric conversion chart see Figure 268.

At the Equator, 1 degree of longitude is also about 69 miles but it decreases to zero miles as you go north or south to each pole.

Every 15 degrees of longitude represents 1 hours time change. Across the Continental United States there are 4 time zones which cover about 3000 miles. If you travel west from the Prime Meridian, set the clock back for each time zone of 15 degrees, but set the date ahead when crossing the International Date Line. When traveling east, set the clock ahead for each time zone you cross, but set the date back when crossing the I.D.L.

CONVERSION CHART FROM CUSTOMARY TO METRIC AND VICE VERSA			
	When you know:	You can find:	If you multiply by:
LENGTH	inches	millimeters	25
	feet	centimeters	30
	yards	meters	0.9
	miles	kilometers	1.6
	millimeters	inches	0.04
	centimeters	inches	0.4
	meters	yards	1.1
	kilometers	miles	0.6
AREA	square inches	square centimeters	6.5
	square feet	square meters	0.09
	square yards	square meters	0.8
	square miles	square kilometers	2.6
	acres	square hectometers (hectares)	0.4
	square centimeters	square inches	0.16
	square meters	square yards	1.2
	square kilometers	square miles	0.4
square hectometers (hectares)	acres	2.5	
MASS	ounces	grams	28
	pounds	kilograms	0.45
	short tons	megagrams (metric tons)	0.9
	grams	ounces	0.035
	kilograms	pounds	2.2
	megagrams (metric tons)	short tons	1.1
LIQUID VOLUME	ounces	milliliters	30
	pints	liters	0.47
	quarts	liters	0.95
	gallons	liters	3.8
	milliliters	ounces	0.034
	liters	pints	2.1
	liters	quarts	1.06
	liters	gallons	0.26
TEMPERATURE	degrees Fahrenheit	degrees Celsius	5/9 (after subtracting 32)
	degrees Celsius	degrees Fahrenheit	9/5 (then add 32)

Figure 268 A Metric Conversion Chart

THE TOPOGRAPHICAL MAP

For our purpose the best map to use and become familiar with is the topographical map. These maps are made by taking several overlapping photographs from the air by using special photographic equipment. These photos are then given to a photogrammetrist who specializes in making reliable measurements from the aerial photos and drawing details on the map. This information is then supplemented by additional data collected by field surveyors, such as the latitude, longitude and elevation, etc.

To facilitate the identification of certain features on topographical maps, certain colors are used to represent certain features:

1. Black - The majority of cultural or manmade features.
2. Blue - Water features such as lakes, rivers, swamps, wells, etc.
3. Green - Vegetation, such as woods, orchards or vineyards.
4. Brown - All relief features such as contours.
5. Red - Main highways, built-up areas and special features.
6. Other colors may be used to show special information. These are usually indicated in the marginal information.

In the process of making a map, everything must be reduced from its actual size on the ground to the size at which it appears on the map. This requires, for the purposes of clarity, that some of the symbols be exaggerated. They are positioned, however, in such a manner that the center of the symbol remains in its true location. See Figure 269.

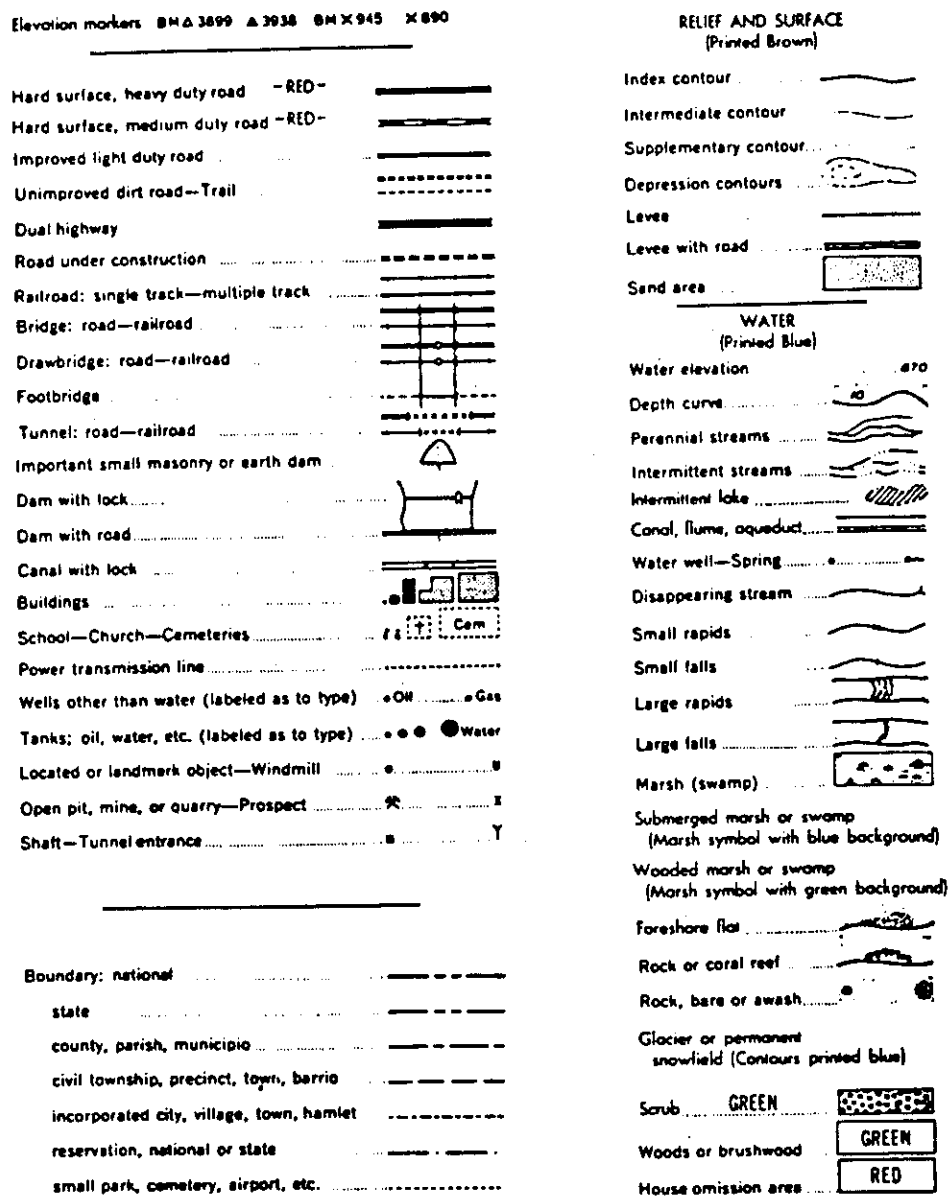

Figure 269 Topographical Map Symbol Chart

Topographical maps basically show five things:

1. Descriptions which are found on the margins of the map.
2. Details, including map symbols, colors, features and contours.
3. Directions showing true and magnetic north lines.
4. Distances, by way of bar scales, printed mileage from city to city and distances from the Equator etc.
5. Designations, such as hydrographic printing which is used for waters and regular print for other things. Degrees are designated as °, minutes as ' and seconds as ''.

When using a map it is best to go out into the field and actually work with a map. If you don't know where to go or who owns the land, get a current County Atlas and Plat Book. This gives all the information on who owns what land in each county of the state. Get permission from the land owners before going into the field. If you intend to lay out compass courses, etc., when using this type of map, be sure to have a 360° protractor or an arm protractor. This will aid immensely in setting up compass bearings and measurements.

As stated before, topographical maps are exceptionally good maps for the camper, hiker and outdoorsman. There is a lot of information on a topographical map. When an intelligent person wants to know about and use any new piece of equipment, he realizes that the best procedure is to read the instructions first. This is also true of a topographical map. When using a topographical map, one of the most important things is to be able to understand the marginal explanations located on the margins of the map. Most of these marginal explanations are innumeraed here. If necessary, use further references for things you do not understand.

MARGINAL EXPLANATIONS OF THE TOPOGRAPHICAL MAP

1. These maps are also called topographical sheets, quadrangles or contour maps. The information includes the name of the map, the state and county and the specific location. The map is usually named for the outstanding cultural or geographical feature or, whenever possible, the name of the largest city on the map. These quadrangles are usually in one or two series which are the:
7.5 Minute Series in which 8 of the maps are equal to 1°
15 Minute Series in which 4 of the maps are equal to 1°
2. Longitude and latitude are given in the four corners of the map showing degrees, minutes and seconds. 60" equal 1 minute and 60' equal 1 degree. Minutes and seconds are also shown on the map margins every 2.5 minutes. With this feature you can draw in extra parallels and meridians if desired.
3. Names and numbers of the 8 adjoining maps are shown on each map.
4. The Township and Range numbers are indicated on a topographical map. A Congressional Township is a square tract of land with sides of 6 miles each, and containing 36 sections of land. A

Civil or Political Township may be larger or smaller than a Congressional Township. The reason for this is that years ago when the original survey of this state was made by the government engineers, they knew that it was impossible to keep a true north and south direction of township lines, and still keep getting township squares of 36 square miles. As they surveyed toward the north pole, they were constantly running out of land, because the township lines were converging toward the north pole.

On some township maps, you will notice that on the north and on the west of each township, there are divisions of land which show odd acreages. In some townships, these odd acreages are called government lots (because they were given a lot number), and at other times left as FRACTIONAL FORTIES OR EIGHTIES. It was at the option of the original government surveyors as to whether they would call these odd acreages government lots or fractional forties and eighties.

The reason for these odd acreages is that the government surveyors adjusted for shortages of land which developed as they went north by making fractional forties, eighties or government lots out of the land on the west side of a township, and the same for the land on the north side of a township to keep east and west lines running parallel. In other words, it was impossible to fit full squares into a circle.

Townships sometimes vary in size from the regularly laid-out townships. See Figure 270-A. Suppose that the dotted line in Figure 270-A is a river separating two counties. The land north and west of the river could be a township in one county, the land south and east could be a township in another county. Whichever county the land is in, it still retains the same section, township and range numbers for purposes of land descriptions.

Each township has a township number and also a range number. (Sometimes more than one of each if the township is oversized, or a combination of more than one township and range).

Government surveying of townships is run from starting lines called base lines and principal meridians. Each township has a township number. This number is the number of rows or tiers of townships that a township is either north or south of the base line. Also each township has a range number. This number is the number of rows or tiers of townships that a township is either east or west of the principal meridian. See Figure 270-B. EVERY DESCRIPTION OF LAND SHOULD SHOW THE SECTION, TOWNSHIP AND RANGE IT IS LOCATED IN. Figure 270-C shows how sections are subdivided into acres.

5. Mileage is shown to the next town or towns on principal highways.
6. Road classifications are pointed out.

6	5	4	3	2	1
7	8	9	10	11	12
18	17	16	15	14	13
19	20	21	22	23	24
30	29	28	27	26	25
31	32	33	34	35	36

A CONGRESSIONAL TOWNSHIP
CONTAINS 36 SECTIONS OF LAND
1 MILE SQUARE

A CIVIL OR POLITICAL TOWNSHIP
MAY BE LARGER OR SMALLER THAN
A CONGRESSIONAL TOWNSHIP.

A. How Sections in a Township Are Numbered

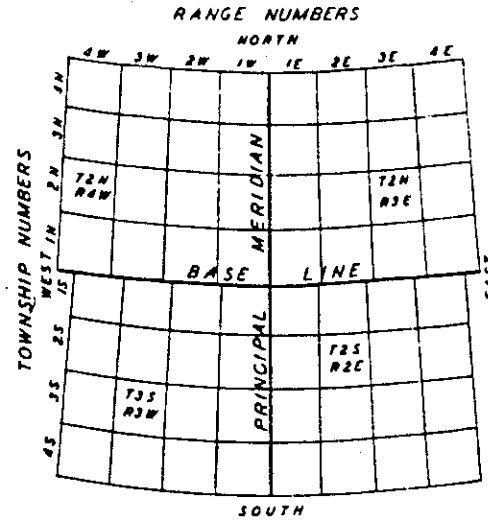

B. Ranger Numbers in a Township

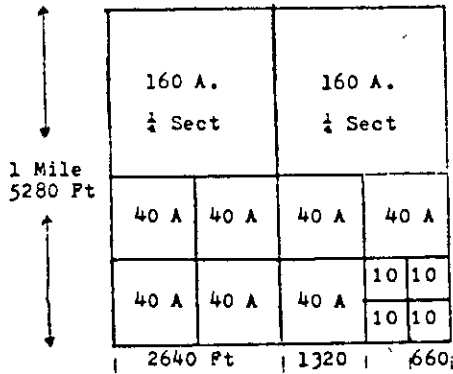

One section of land is 1 mile square consisting of 640 Acres.

One half section is 320 Acres

One Quarter Section is 160 Acres

One sixteenth of a section is 40 Acres

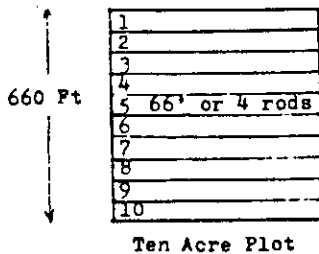

An Acre originally was the amount of land plowed by a yoke of oxen in a day which was about 660 feet by 66 feet or about 40 rods by 4 rods, a rod being equal to 16 1/2 feet.

160 square rods or 43,560 square feet equal an acre.
An Acre is a tract of land 40 rods by 4 rods.

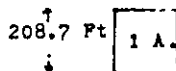

An acre is 208.7 feet on each side if laid out square

C. How Sections are Subdivided into Acres

Figure 270

7. The age of the map is indicated.
8. AMS is the Army Map Service showing the edition numbers of the Geological Survey Map and Army Series Reference Number. This is used chiefly by the Army Corp of Engineers.
9. The quadrangle location within the state is shown in the margin.
10. The Scale of the Map, Bar Scale and Contour Interval Data. National Geodetic Vertical Datum of 1929 (Example) designates the basis for all vertical control stations, contours, and elevations on the map.
11. The Declination Diagram is shown with true, magnetic and grid north.

True North is a line from any position on the earth's surface to the true north pole.

Magnetic North is the direction to the north magnetic pole as indicated by a compass. See Page 172.

Grid North is the north that is established by the vertical grid lines on the map. These grid lines are meridian lines which converge at the poles.

12. **Miscellaneous Data:**

Mapped, edited and published by the Geological Survey with control by United States Geological Survey, National Oceanic Survey, and the National Oceanic and Atmospheric Administration and also the State Highway Department. Sometimes controls are by the Army Map Service and Corp of Engineers.

Date of Aerial photographs and date of Field Checks are also shown.

13. UPSG - Universal Polar Stereographic Grid is the rectangular grid system used in the Polar regions.

14. **Projection and 10,000 foot Grid Ticks:**

Each state has its own Coordinate Marking System which shows a footage marking system which is used by state map makers, surveyors, etc.

THE STATE COORDINATE SYSTEM is a method of measuring used by the different states. It is used chiefly by the Department of Transportation and Surveyors. Each state is divided into zones with each zone having its own coordinates as an index or reference point from which footage is measured from that point.

Minnesota, for an example, is divided into 3 zones - North, Central, and South. The South Zone has its index point at a latitude of 43 degrees 00" with a value of zero. For each minute going north, the footage amounts to about 6000 feet (6076.11). Rochester, Minnesota, is at approximately 44° north latitude or 60 minutes north of the 43 degree reading of zero. This would amount to about 364,000 land feet plus. ($6076.11 \times 60' = 364,566$ feet)

The meridian coordinates for the South Zone of Minnesota is set at 94 degrees 00' which is set at an arbitrary figure of 2,000,000 feet. West of this meridian the footage reduces while to the east of the meridian the footage goes up. Each minute of footage is approximately 4,667 feet. Rochester, Minnesota, is at 92 degrees 30' east of the 94th meridian or about 90 minutes. So, Rochester, Minnesota, which is in the South Zone is approximately 90 minutes east of 94 degrees longitude or at 2,420,030 feet. (4,667 x 90 equals 420,030 plus 2,000,000 or 2,420,030 feet)

15. THE UNIVERSAL TRANSVERSE MERCATOR GRID SYSTEM:

These are grid ticks showing the meter markings, both along the vertical and horizontal margins of a topographical map, which make it possible to pinpoint any definite spot located on the earth between a Latitude of 84 degrees North and Latitude of 80 degrees South.

To explain the UTM Grid System you must visualize a world globe with the 360 meridian lines drawn in from pole to pole. Then you must cut off a small piece at the top of the globe at Latitude 84 degrees North and another slice from the bottom of the globe at Latitude 80 degrees South. Now if you delete 300 meridians on this imaginative globe and left 60 of the meridians each 6 degrees apart starting at the 180 degree meridian, you would have 60 equal vertical zones around the earth as shown in Figure 271.

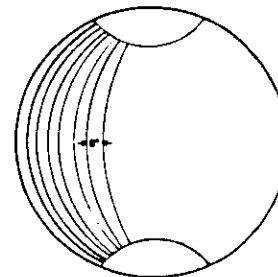

Figure 271 A Universal Transverse Mercator Zone

Each of these zones forms the basis of separate map projections, which can be divided into a basic set of maps of any convenient size. Maps in North America are usually scaled to 1:250,000; 1:125,000; 1:63,360; 1:62,500; 1:25,000 and 1:24,000 etc. This simply means that one unit on the map is equal to so many units in the field.

These zones are then numbered from west to east, 1 through 60, starting at the 180 degree meridian. The Continental

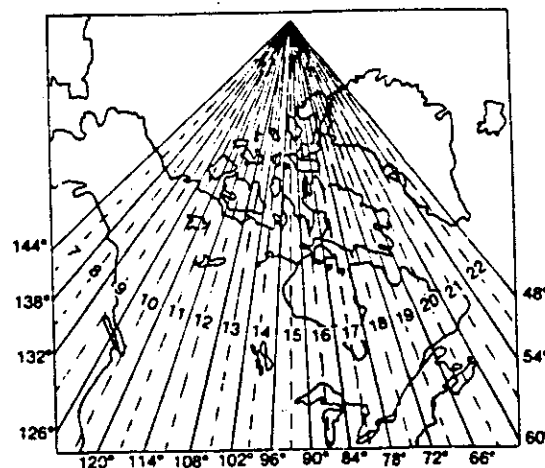

Figure 272 UTM Zones and Central Meridians for Northern United States and Canada

United States and Canada lie in Zones 7 through 22. Zone 10 to 20 cover the Continental United States. See Figure 272.

The zones are divided by the Equator into North and South Latitudes. Each of the 6 degree zones are equally subdivided vertically by a Central Meridian leaving three degrees on each side of the Central Meridian within any given zone. All vertical lines run parallel to the Central Meridians of each zone. If you could peel off each zone from the globe and lay it on a flat surface, the zone being only 6 degrees of longitude wide would be relatively distortion-free. (6 degrees of longitude at the Equator would equal about 666 kilometers or 414 miles). Figure 273 shows the shape of a single Universal Traverse Mercator Zone.

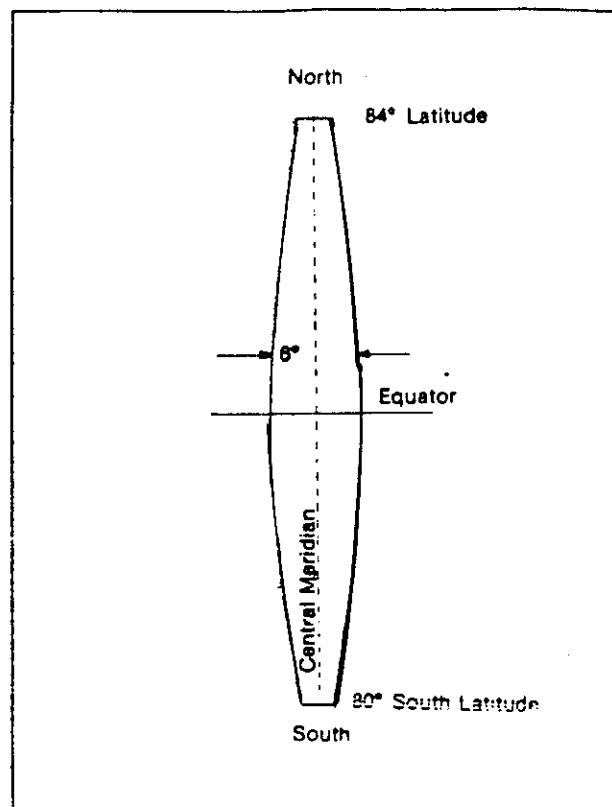

Figure 273 The Shape of an Individual Universal Traverse Mercator Zone

To facilitate locations and measurements in a zone, a two way rectangular grid system furnishes the map reader with a system of squares or small tick marks which extend into the body of the map.

In the Northern Hemisphere, starting with zero at the Equator, topographical maps show the ground distance of each thousand meters of distance as you travel north to Latitude 84 degrees. Various sized maps may show grids from 100 meters to 100,000 meters depending on the scale and purpose of the map. At any point on the earth the ground distance covered by 1 degree of latitude is approximately 111 kilometers (69 miles); 1 minute is approximately 1800 meters (6000 feet) and 1 second is equal to approximately 30 meters (100 feet).

As stated before, the ground distance covered by 1 degree of longitude, at the Equator, is also approximately 111 kilometers (69 miles), but it decreases as one moves north or south until it becomes zero at the poles. For an example, one second of longitude represents about 30 meters at the Equator but at the latitude of Washington D.C., which is approximately 38 degrees 45' 7", one second of longitude is about 24 meters (78 feet)

and one degree of longitude would equal about 86.4 kilometers (54 miles).

The vertical grid lines, or ticks, are measured from the Central Meridian of each zone which has a value of 500,000 meters East. The readings to the left of the 500,000 meter line will count downward and those to the right of it will count upward of 500,000 meters, but all meter readings will have an "Easting" value. Distances are then measured right and up (east and north as the reader faces the map). Therefore, in the Western Hemisphere all of the vertical Universal Transverse Mercator Grid readings will be EAST. To pinpoint a small reference point on a 1000 meter grid map see Figure 274. There is a similar reference in the gridding system in the Southern Hemisphere, but it is far enough away that confusion will not result.

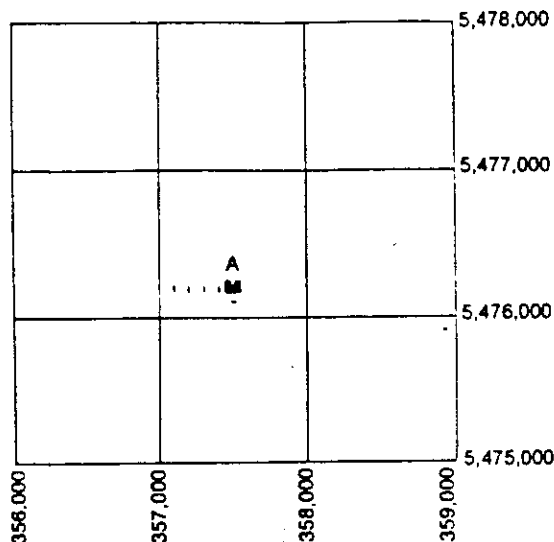

Reading Map References Quickly and Accurately

1. To find reference of buildings: estimate the number of meters east of 357,000, which is approximately 500 meters. Set it down as 357,500. This is known as Easting.

2. Find the number of the grid line south of the building - 5,476,000. Estimate how far north the building is of this grid line - approximately 200 meters. Set it down as 5,476,200. This is known as Northing.

Figure 274 Reading a Map Reference

ALTITUDE, RELIEF AND CONTOUR LINES

As mentioned before, a topographical map portrays in a measurable form the terrain, landforms and horizontal positions of the features shown.

The earth's surface is a continuous series of landforms (hills, ridges, valleys and plains). The altitude of these landforms range from 29,028 feet above sea level at the summit of Mount Everest in Asia, to 1,292 feet below sea level at the surface of the Dead Sea in the Middle East. The vertical distance a point lies above or below mean sea level is referred to as elevation. The inequalities in elevation and the configuration of the land features of the map is called relief. Elevation and relief features are depicted on the map by contour lines.

The contour lines are interpreted through the use of contour interval represented in the marginal information of the map. Figure 275 depicts a hill above sea level on a map. To the left is an artist's sketch of the hill including elevations or altitude of the hill.

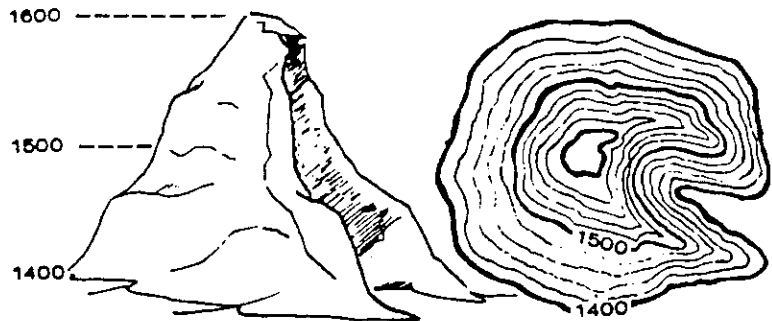

Figure 275 Depiction of a Hill Above Sea Level

Contour lines are the brown lines on the map representing imaginary lines on the ground. Each contour line connects points of equal altitude and is a definite vertical distance above or below the other contour lines on the face of the map. Each contour line is a continuous line closing on itself, which may appear on a single map sheet or on an adjacent map sheet. They never fork or split. They touch only at vertical cliffs and cross (intersect) only at overhanging cliffs.

The contour interval is expressed in feet or meters and may vary from map to map depending on the scale of the map and relief of the area. When working with a new map sheet, you should always check the contour interval in the marginal information.

There are normally three different types of contour lines on a map sheet to assist us in determining the relief of an area.

1. Index Contours are the heavy brown lines. Every fifth line on the map sheet is usually an index contour line and it is labeled with its altitude where space permits. In the example in Figure 276, the 200-foot index contour is indicated by the arrow. Since contours connect points of equal altitude, any point along this contour would have an altitude of 200 feet. The X in the figure indicates a point of 250 feet.

Contour Interval - 10 feet

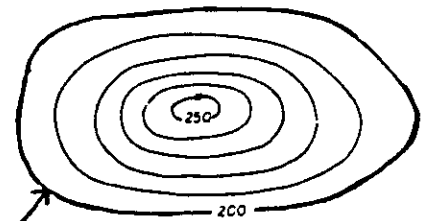

Figure 276 Index Contour

2. Intermediate Contours are the lighter colored lines between the index contour lines and, like the index contour, connects points of equal altitude. You must determine the altitude of these contours by checking the contour interval of the map and then adding or subtracting one contour interval for each intermediate contour above or below the closest index contour. There are usually 4 intermediate contours between each index contour. In Figure 277-A the altitude of the intermediate contour indicated by the X is 320 feet, since it is the second contour above the 300-foot index contour and the contour interval is 10 feet. Point A in the figure is a 340-foot intermediate contour.

Contour Interval - 10 feet

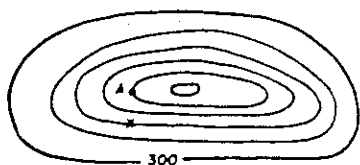

Figure 277-A Intermediate Contour

Contour Interval - 10 feet
Supplementary Interval - 5 feet

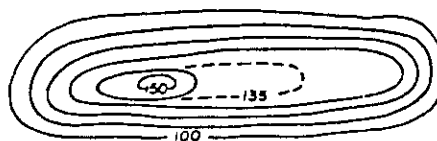

Figure 277-B Supplementary Contour

3. Supplementary Contours portray relief in more detail, particularly in a relatively flat area. These are broken brown lines that are normally placed at one-half the contour interval from the adjacent contours, are usually labeled with their respective altitudes, and are extended only as far as necessary to properly depict the relief of an area. The supplementary contour, for this reason, does not usually close on itself. Supplementary contour interval is normally given in the marginal information of the map sheet. Figure 277-B depicts a supplementary contour line.

SUMMARY

A topographical map is a mathematically determined presentation of a portion of the earth's surface systematically plotted to scale upon a plane. These maps are accurate and they are fun to use. They are excellent maps to use with a compass for orienteering.

If this type of map is relatively new to you, sit down with the map and study it. Start with the marginal information and soon the map will make a lot of sense to you.

If you want a particular quadrangle of your area write to the United States Geological Survey, Federal Center, Denver, Colorado 80225, and ask for a State Index Map. From this index map you can order any of the available quadrangles for your particular state.

CHAPTER 9

THE COMPASS

The compass is the basic direction-finding device for terrestrial navigation. The basis of the magnetic compass is that the earth itself is a giant bar magnet whose north-south orientation causes a freely suspended magnetized steel needle to assume a similar alignment.

HISTORY

The Chinese are given credit for first inventing and using the magnetic compass. They first used it to guide their ships in the 11th and 12th centuries. These compasses were simple pieces of magnetic iron ore which were usually floated on straw or cork in a bowl of water.

This magnetic iron was called loadstone. It is a hard black stone occurring naturally as magnetic iron ore. It is composed principally of iron oxide and is made up of magnetite, which is a ferro-ferris oxide exhibiting magnetic properties.

TYPES OF COMPASSES

There are three main categories of compasses:

1. Solar or Sun Compasses, the use of which depends upon the sun or a star being visible. These operate somewhat in reverse of a sundial.
2. Gyrocompasses, which obtain their directive control from the rotation of the earth. It is independent of the magnetic field of the earth and depends upon the properties of the gyroscope along with the earth's rotation.
3. Magnetic Compasses, which depend upon the earth's magnetic field to obtain its directive force. There are four types of magnetic compasses:
 - a. The Gyromagnetic Compass, which is designed to overcome the problem of compass alignment created by changes in the course and speed of aircraft etc. It has a means of comparison between the gyroscope and that of the magnetic element.
 - b. The Inductor Compass is a little more complicated. The pivoted-needle magnetic compass indicates direction by

aligning itself with the horizontal component of the earth's magnetic field. The inductor compass, on the other hand, in effect measures the strength of this horizontal component and indicates the direction in which the strength is maximum.

- c. The Aircraft Compass is essentially a mariner's compass modified to damp out shocks produced by the aircraft. The direct reading of the magnetic compass was reduced to a secondary role, its place being taken, for most purposes, by the gyromagnetic compass.
- d. The Mariner's Compass and related magnetic land compasses depend upon the earth's magnetism and a magnetized needle or dial. For the most part, land compasses are of the needle or dial variety. Figure 278 shows three common types of conventional compasses: The Lensatic Dial Compass, the "Watch Case" needle type compass and the Silva liquid filled needle compass.

A great number and variety of compasses are made by the Silva Company. These Silva-Systems Compasses come in a large selection of styles, shapes and designs with a compass for every purpose. Perhaps the most popular compasses are the liquid filled needle compasses. Although there are induction dampened compasses and air-filled compasses, the liquid filled compasses are now almost universally used because it slows down the jiggling of the needle and brings it to rest more quickly, and at the same time, the compass is not too costly. It makes a good orienteering compass. Figure 278-D shows the parts of the Silva liquid filled needle compass.

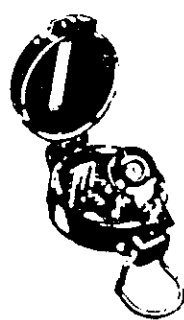

A. Lensatic Dial Compass

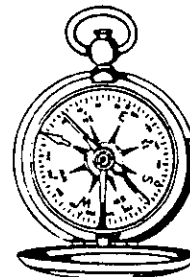

B. "Watch Case" Needle Compass

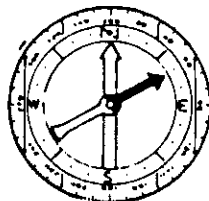

C. Silva Liquid Filled Needle Compass

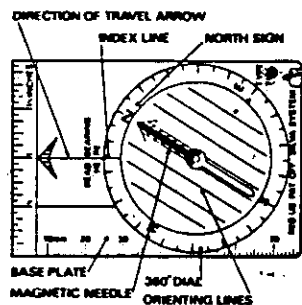

D. Parts of The Silva Liquid Filled Needle Compass

Figure 278

THE OLD MARINER'S COMPASS

When the old mariner's compass was installed on a ship, it was mounted in a stand called a binnacle which was equipped with magnetic devices which corrected errors of deviation. This old type compass had several magnets fastened on a flat disk, called a compass card. This compass card was marked with the points and degrees of direction. The card rested on a pivot so it could turn freely inside the glass covered compass bowl, and would always point toward magnetic north. The compass bowl was filled with a nonfreezable liquid mixture which floated the card so that it would not constantly swing from side to side with the motions of the ship. A vertical line, called a lubber's line, was marked inside the compass bowl. The compass bowl was mounted so that the lubber's line was toward the bow of the ship. Thus the compass card point, opposite the lubber's line, indicated the direction the ship was heading.

Old style compasses such as the mariner's compass, are marked with thirty-two points or principal directions. The "cardinal points" are North, East, South, and West. The "inter-cardinal points" are Northeast, Southeast, Southwest and Northwest. The compass is divided still further by 24 more points. These, in turn, are divided again into quarter points. Boxing the compass is to name the thirty-two directions marked on the face of a mariner's compass. Each of the thirty-two points is again subdivided into quarter points for purposes of fine steering on ships. Figure 279 shows the way you would box a compass by quarter points running to the right or with the sun. The thirty-two main points of a mariner's compass are starred. It is given in full to show the accepted manner of naming all points of the compass.

1st Quadrant	2nd Quadrant	3rd Quadrant	4th Quadrant
*North	*East	*South	*West
N.1/4E.	E.1/4S.	S.1/4W.	W.1/4N.
N.1/2E.	E.1/2S.	S.1/2W.	W.1/2N.
N.3/4E.	E.3/4S.	S.3/4W.	W.3/4N.
*N.xE.	*E.xS.	*S.xW.	*W.xN.
N.xE.1/4E.	E.S.E.3/4E.	S.xW.1/4W.	W.N.W.3/4W.
N.xE.1/2E.	E.S.E.1/2E.	S.xW.1/2W.	W.N.W.1/2W.
N.xE.3/4E.	E.S.E.1/4E.	S.xW.3/4W.	W.N.W.1/4W.
*N.N.E.	*E.S.E.	*S.S.W.	*W.N.W.
N.N.E.1/4E.	S.E.xE.3/4E.	S.S.W.1/4W.	N.W.xW.3/4W.
N.N.E.1/2E.	S.E.xE.1/2E.	S.S.W.1/2W.	N.W.xW.1/2W.
N.N.E.3/4E.	S.E.xE.1/4E.	S.S.W.3/4W.	N.W.xW.1/4W.
*N.E.xN.	*S.E.xE.	*S.W.xS.	*N.W.xW.
N.E.3/4N.	S.E.3/4E.	S.W.3/4S.	N.W.3/4W.
N.E.1/2N.	S.E.1/2E.	S.W.1/2S.	N.W.1/2W.
N.E.1/4N.	S.E.1/4E.	S.W.1/4S.	N.W.1/4W.
*N.E.	*S.E.	*S.W.	*N.W.
N.E.1/4E.	S.E.1/4S.	S.W.1/4W.	N.W.1/4N.
N.E.1/2E.	S.E.1/2S.	S.W.1/2W.	N.W.1/2N.
N.E.3/4E.	S.E.3/4S.	S.W.3/4W.	N.W.3/4N.
*N.E.xE.	*S.E.xS.	*S.W.xW.	*N.W.xN.
N.E.xE.1/4E.	S.S.E.3/4E.	S.W.xW.1/4W.	N.N.W.3/4W.
N.E.xE.1/2E.	S.S.E.1/2E.	S.W.xW.1/2W.	N.N.W.1/2W.
N.E.xE.3/4E.	S.S.E.1/4E.	S.W.xW.3/4W.	N.N.W.1/4W.
*E.N.E.	*S.S.E.	*W.S.W.	*N.N.W.
E.N.E.1/4E.	S.xE.3/4E.	W.S.W.1/4W.	N.xW.3/4W.
E.N.E.1/2E.	S.xE.1/2E.	W.S.W.1/2W.	N.xW.1/2W.
E.N.E.3/4E.	S.xE.1/4E.	W.S.W.3/4W.	N.xW.1/4W.
*E.xN.	*S.xE.	*W.xS.	*N.xW.
E.3/4N.	S.3/4E.	W.3/4S.	N.3/4W.
E.1/2N.	S.1/2E.	W.1/2S.	N.1/2W.
E.1/4N.	S.1/4E.	W.1/4S.	N.1/4W.
*East	*South	*West	*North

Figure 279 **Boxing the Compass by Quarter Points Running With the Sun**

MODERN COMPASSES

Modern compasses are usually marked with the sixteen main points and with the 360 degrees of a circle starting with 000 at North, 090 at East, 180 at South and 270 at West. Each degree is divided into 60 minutes and each minute into 60 seconds. These degrees are used to indicate and find directions. A direction expressed in this way is called a bearing or magnetic azimuth. Azimuth comes from the Arabic "al" meaning "the" and "zimut" meaning "way": "The Way." All bearings should be expressed in three figures to prevent mistakes. It is not read "30 degrees," for example, but "030 degrees."

The simplest form of the compass is a magnetic needle which turns. The needle is mounted on a pivot. The needle can move freely, but always comes to rest pointing in the direction of the magnetic north and south poles. The fact that the earth itself is a tremendous magnet, with one magnetic pole in the north and the other in the south, makes the magnetic compass possible.

DECLINATION (VARIATION)

The magnetic north pole is the pole to which the compass needle points. It lies near Bathurst Island in Northern Canada, about 77° north latitude and 103° west longitude. The terrestrial, or true north pole, is the northern end of the axis about which the earth revolves and the place where the meridians all meet on a globe. As previously stated, the magnetic north pole is some 1400 miles south of the true north pole. Conventional compasses do not point true north, but instead, they point toward magnetic north.

In the United States, unless a person is on a line that runs roughly from Northern Wisconsin through Illinois, Tennessee, and Birmingham, Alabama, and along the Western coast of Florida, his compass will point either east or west of true north. If he lives on this line in the United States, the compass will point at about true north (Figure 280-A). This line is called the agonic line. This is an imaginary line around the earth's surface on which there is no angle of declination between true north and magnetic north. This is the "no angle" line. If he lives east of that line, his compass will point west of true north. This is called a westerly declination. If he lives west of the agonic line his compass will point east of true north, and this is called easterly declination. Compass declination or variation as it is sometimes called, is the term which is used to denote the difference between magnetic north and true north. Thus, as the compass needle points to the magnetic pole it forms an angle with the geographical north pole. This is called the angle of declination. Therefore, to use a compass accurately, one must have a declination chart which shows exactly what variation correction must be made in reading a compass in any particular locality. Figure 280-B shows a schematic drawing to aid in understanding easterly and westerly declination. To adjust your compass for declination in the United States and Canada, subtract the number of degrees of easterly declination or add the number of degrees of westerly declination to your bearing.

It is interesting to note that the agonic line does not follow the pattern of the meridians. Instead, in the Americas the line continues south from Florida through Panama, Peru and Argentina to the South Magnetic Pole. The other leg of the agonic line enters Europe through Scandinavia and goes south to Italy, Libya and Somalia and then veers to Southern Pakistan, through India to China. The line then goes through China and Mongolia, and through the central part of the Soviet Union to the Arctic Ocean. Then it swoops southward through the Philippines, west towards Vietnam and south through Eastern Sumatra and western Australia to the Magnetic South Pole. See Page 172. It must be remembered that the agonic line is the no-angle line. Along that line there is no angle between true and magnetic north. It also must be remembered that the Magnetic North Pole moves slowly from year to year. Likewise, the agonic and isogonic lines change somewhat from year to year.

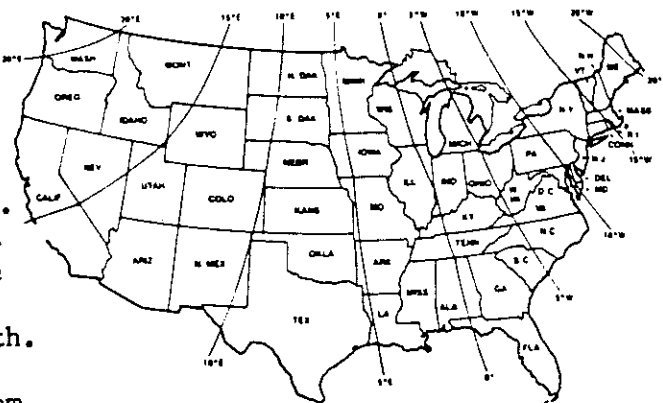

Figure 280-A Declination Chart of the United States

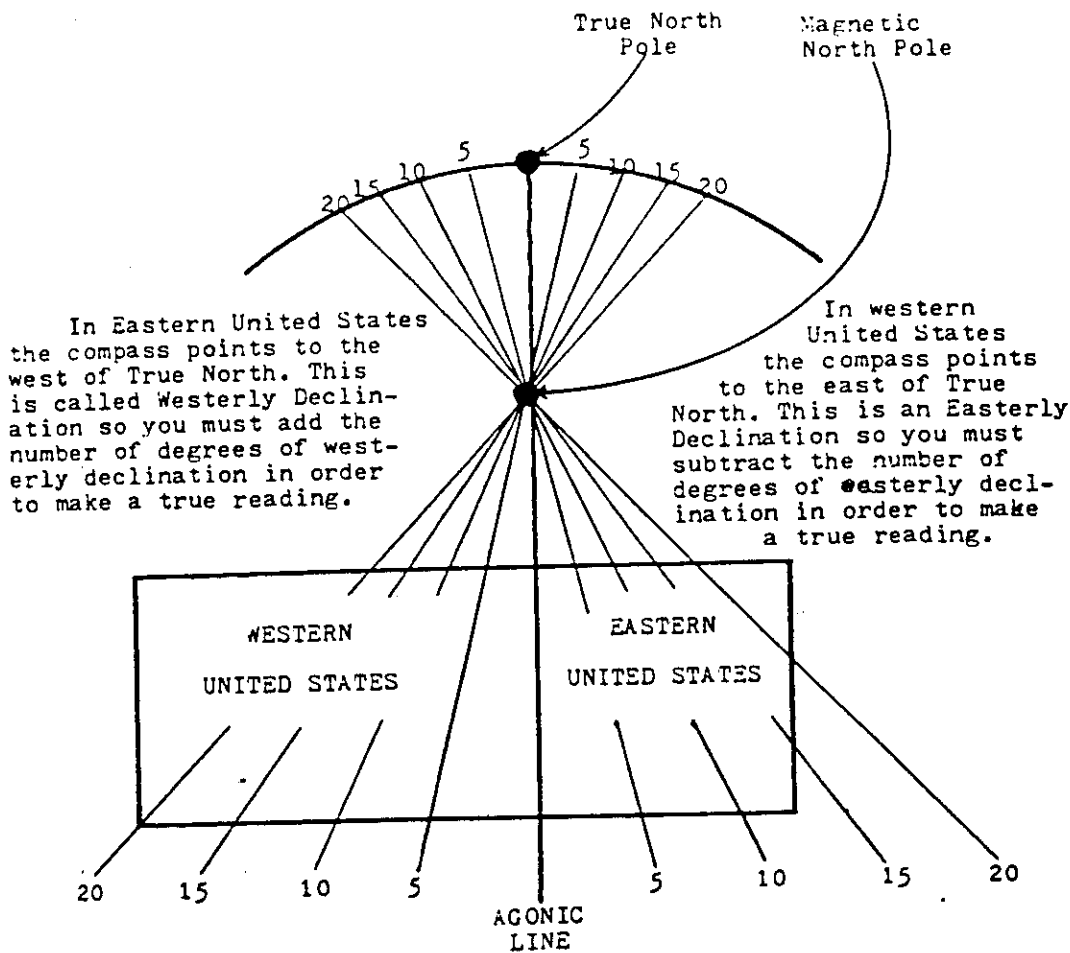

Figure 280-B Schematic drawing to Aid in Understanding Easterly and Westerly Declination (Variation).

DEVIATION

There is one other error that we will be concerned with in this chapter. If a compass is placed close to an iron or steel object, the compass needle may be attracted toward that object. This error is called deviation. Underground ore deposits, being too close to railroad tracks, metal poles or fences, unseen steel girders in buildings and even belt buckles will affect a compass. Deviation together with declination is called compass error.

COMPASS ERROR

To summarize compass error, remember that a compass points to compass north. If there is no deviation, or if correction is made for it, the compass points to magnetic north. After the correction is made for declination (variation), the compass will manifest a true north reading.

STYLES OF LAND COMPASSES

There are many different styles of dial and needle compasses. One of the easiest to use is the dial compass. To secure a reading:

1. Place the compass on a flat solid surface.
2. Wait until the dial comes to rest.
3. Read the bearing directly from the dial.

When using the needle type compass:

1. Steady the compass on a flat surface so the dial will move freely.
2. "Set the compass." This is done by waiting until the compass needle stops swinging.
3. Turn the case gently until the north marking on the case fits under the north end of the needle. This is called orienting the compass.
4. To take a compass bearing, sight over the desired degree reading to some object or landmark in the field.

Remember, when taking a reading you may want to adjust for declination. If so, remember the rule: subtract easterly and add westerly variation.

MAKING A TEMPORARY COMPASS

Sometimes you can make a good program by making some type of temporary compass. There are several ways this can be done. One of the easiest methods is to follow these six steps:

1. Stroke a regular sewing needle in a single direction with a piece of loadstone, a piece of silk or a magnet. This magnetizes the needle.

2. After the needle is magnetized, rub the needle with skin oil from the nose or behind the ear.
3. Float the needle on an overflowing cup of water away from metal. You can float the needle by lowering it carefully into the water holding the needle with two blades of grass. An easier method is to float the needle on a piece of cork. See Figure 281-A.
4. If you stroke the needle with the north end of the magnet, from tip to eye, the eye will point south.
5. If you stroke the needle with the south end of the magnet, from tip to eye, the eye will point north and visa versa.
6. If you do not know the polarity of the magnet, you will have to check the magnetized needle with the known direction or with a compass needle.



Magnetizing a sewing needle with a magnet

A.

Electromagnetism

A needle may be magnetized by a battery and coil method by wrapping a two-inch square of paper around a nail that is a bit thicker than the needle. Wrap magnet or bell wire around the paper as shown, then remove the nail. Attach the end of the coil wire to one of the battery terminals and slip the needle into the coil point first. Then attach the other end of the wire to the other terminal for not more than 10 seconds. (If you leave it longer the wires get hot and weaken the battery.) If you use insulated wire, the paper is not needed. If the coil wrappings are clockwise, the end of the needle pointing toward the positive pole of the battery will be the north end and visa versa.

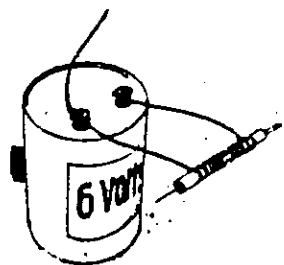

B.

String & Needle Compass

Stroke one end of a sewing needle against one pole of a magnet. Tie a fine thread in the middle of the needle so it balances. Hold thread a foot above needle which will swing to a N-S position. (Mark north end.)



C.

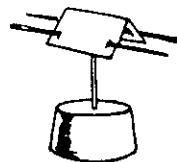

D.

Two-Needle Compass

Magnetize two needles with a magnet - the head of one and point of the other. Fold an inch square piece of paper and insert needles as shown. Balance the paper on a third needle. The compass should swing north. (Mark north ends.)

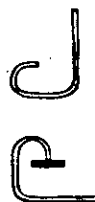

E.

Paper-Clip Compass

Bend a steel paper clip as shown. Stroke the top of the "J" with a magnet. Balance the compass on a coin or smooth surface and it will line up North-South. (Mark north end with a felt-tip marker.)

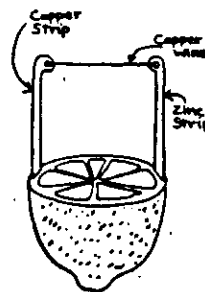

F.

Lemon Compass

Push thin strips of copper and zinc into opposite sides of a lemon half, and join them with copper wire. Float lemon in a bowl of water. Electrical current flowing through the wire will cause the lemon to turn until the copper points west and the zinc east.

Figure 281 Making Temporary Compasses

When making a temporary compass it is often necessary to magnetize a sewing needle. This can be done as above, or another way this can be done is to use the battery and coil method. Start by wrapping a two-inch square of paper around a nail that is a bit thicker than your needle. Now wrap magnet wire or bell wire around the paper as shown in Figure 281-B. Then remove the nail. Attach one end of the coil wire to one of the battery terminals and slip the needle into the coil point first. Then attach the other end of the wire to the battery for no more than 10 seconds. (If you leave it longer, the wire will get hot and weaken the battery.) The needle should be strongly magnetic.

MEASURING GROUND DISTANCE BY PACING

In compass work it is often times necessary to be able to pace the distance between two points and to convert your paced distance into feet, meters or miles.

Pacing means to measure by paces or steps. However, distance must be expressed in units of known value such as in feet, yards, meters, kilometers or miles.

If you determine beforehand how many of your normal paces it takes for you to cover a measured distance, you can use this information to convert a distance in your paces to a distance in units such as feet or meters. The result will be fairly accurate within plus or minus 10 percent of the actual distance. To determine your number of paces to cover a given distance, do the following:

1. Carefully measure a 100-foot course on level terrain.
2. Being careful to walk your normal pace, walk this course three times, each time counting your paces.
3. Determine the average number of paces it took to walk the course. (Add the number of paces for each time and divide the sum by the number of times you walked the course.)

Example: You walked a 100-foot course three times. Once at 37 paces, once at 42 paces and once at 41 paces. How many paces, on the average, do you take in a 100-foot course?

SOLUTION: 40 paces

<u>Step 1</u>	Add	37
		42
		41
		<hr/>
		120
<u>Step 2</u>	Divide by 3 to get the average	
	120 divided by 3 =	40 paces

Every 40 paces you will have traveled 100 feet.

Supposing you walked a 100 meter course three times. Once at 116 paces, once at 123 paces and once at 121 paces.

Step 1 Add 116
 123
 121
 360

Step 2 360 divided by 3 = 120 paces

Every 120 paces you will have traveled 100 meters.

When measuring distances of several hundred meters or several hundred feet it is sometimes necessary to work out a convenient system of keeping a record for every 100 feet or meters traveled. One method of doing this is to carry a piece of string and tie a knot in it every 100 units. When the distance is completed count the number of knots in the string.

If pace counts are left over at the end of the course or the total distance paced is less than 100 units, simply multiply the number of paces you took by 100 and divide the result by your average paces per 100. Assuming you checked your pace on a 100 meter course the result would be the distance in meters.

WALKING AND RUNNING SPEEDS

Right along with pace measurement is walking and running speeds. How long does it take the average person to walk one mile on the highway? The average walking speed on flat surface is about 3 miles per hour. Figure 282 shows a chart with the average speeds that a person can make on foot over various terrain.

Number of Minutes To Cover 1 Mile	Highway	Open Field	Open Woods	Mt and Forest
Walking	15	25	30	40
Running	10	13	16	22

Figure 282 Average Speeds to Walk and Run One Mile on Various Terrain

If you are canoeing on lakes, the average speed for the average canoeist is about 4 miles per hour with a maximum of 20 to 30 miles per day.

ORIENTEERING

Orienteering is the skill of finding your way in the field with a compass and map. Many adventures in fun are awaiting when a leader utilizes the compass in program planning and in orienteering. However, in setting

up such a program, it must be remembered that people want to do more than learn the basic fundamentals of the compass. They want to use this instrument. They want to use it by themselves and they want to use it in a group. It is not fair to teach the nomenclature of the compass without letting them go into the field and actually putting the compass to work. Therefore, it is necessary for a leader to set up outdoor games and problems so they not only learn to operate the compass but also have fun by doing, while learning.

In many of the compass games and problems it is necessary to employ maps to make programs more enjoyable and more interesting. One thing to remember in using maps of any type is that changes are constantly taking place. New highways are constructed, dams are built and areas flooded, forests are cut and farms established, the course of streams are altered and many other similar changes occur. Obviously, for any use which requires an exact current knowledge of features as they appear on the ground, maps may have to be of recent origin.

In cross-country traveling - or orienteering as it is called - it is well to remember that the vast majority of maps are laid out on a true north-south line rather than magnetic. In using a compass and a map, one of the first things to do is to "orient the map." This means to turn the map so that the directions on the map are lined up with the directions on the ground. Place the map on a flat surface and turn it until the meridian lines on your map indicating north point in exactly the same direction as the north end of the magnetic needle of your compass. The map is then oriented. The map is true; the field is magnetic. So, when working from the map to field, remember to add westerly declination and subtract easterly. When working the opposite way - from field to map - adjustments have to be made in the opposite way. A field bearing magnetic must have westerly declination subtracted from it or easterly declination added to it to arrive at a map bearing true.

Pursuing a bee-line course isn't easy in rough country, and the less you have to consult your compass the better time you can make. The solution is to pick a prominent landmark on your proposed route, go to it, from there sight another landmark, and move on. If landmarks will be difficult to find, it may be necessary to send a companion to the landmark and have him wait there until the one with the compass arrives. Then, of course, the companion must move out to set up a second field objective and so on.

The wise leader will see to it, when making assignments, that beginners are given the shorter routes, and for the most part, open country - leaving the woods and longer treks to the experienced. Experience has shown that woodland areas are difficult to penetrate on a compass bearing, and even the expert woodsman will experience difficulty in traversing a densely wooded area.

Setting up an orienteering event can be as much fun as taking the course. First, you must have a suitable area with permission from the landowners. A supply of maps (preferably topographical) and compasses must be on hand for the individuals or teams. Stations must be marked with flags, letter or code numbers, etc. Then, of course, you will need sufficient help.

Good orienteering takes a combination of four things:

1. Understanding of the instructions.
2. Correct usage of map and compass.
3. Selecting the best choice of routes between stations.
4. Speed in covering the course.

There are several different types of orienteering. Things may be changed or added to make the course more interesting. Four different methods of orienteering are listed here:

1. Route Orienteering. In this type of event you follow a route decided on by the organizers of the event--part of it along roads, part of it cross-country. This route is indicated on a master map put up in camp, and from this map you copy off the route on your own map. As you follow the route with map and compass, you pass a number of stations not marked on the map. The object is to mark the location of each of these stations on your map. The winner of the event is the participant who has found the most stations and has indicated them correctly on his map; speed is not counted, but a time limit should be set.
2. Project Orienteering. A cool event that not only tests your map-and-compass skills but other outdoor skills as well. As you follow the route, laid out as for route orienteering, you arrive at various stations where signs tell you what to do. Projects may be anything from collecting a number of different leaves or boiling a quart of water to deciphering a Morse code message or chopping through a log. The separate scores you receive from the judges located at the different project stations are added to your orienteering score.
3. Point Orienteering. Something different--you are not given a definite route to follow but only the location of a number of points which you have to reach one after the other in numerical order. You must figure out your own route from one point to the next, and decide on the quickest and easiest way of getting there. The organizers of the event may show you all the points on a master map so that you'll know all of them before setting out, but it is more common to have each point revealed one at a time on a marker at each station.
4. Score Orienteering. This event is a variation of point orienteering. For this the map is put up at the starting point with a number of stations marked on it. Next to each station mark a figure indicates the score you'll receive if you succeed in hitting that station. The nearby, easily reached points give you low scores; the faraway, tough-going points, a high score. You have to lay out your own route, planning it in such a way that you'll get the biggest score within the specified time limit.

Along with the vast number of orienteering possibilities there are many other types of field exercises that may be done with the compass alone or with compass and map. These are "type" problems which may have to be altered to fit a particular group or need.

Remember too, whenever making up a field exercise or problem a snappy title stimulates the imagination and the exercise seems to take on more fun.

Listed below are five compass problems which have been tested and proven. Try these for fun and experience:

1. Azimuth to Treasure
2. From Rim to Hub
3. Line Orienteering
4. The Equilateral Triangle
5. Rendezvous at Base Camp

COMPASS FIELD EXERCISES AND PROBLEMS

Problem No. 1 Azimuth to Treasure

This problem is designed for two to eight individuals. If more are taking part, two or more problems could be run at once with minor changes in each problem. In this case, a treasure may be dinner, movie tickets, candy or one of several other things. The treasure should be buried in a box or jar.

Each group would be given a starting point, a compass, map and a piece of paper containing this message: "Your group has been selected to hunt for a buried treasure. From this point you are to proceed for approximately one-half mile on a magnetic azimuth of 078 degrees. At this point you will be in a clearing and you will see an eight foot staff standing vertically from the ground flying a white flag. From the base of the flag pole, follow a true bearing of 325 degrees for twenty steps. Here is where you will find the buried treasure."

Problem No. 2 From Rim to Hub

In this particular problem the leader must select from a topographical map an area in which he could visualize a giant wheel. The hub of the wheel would be a rendezvous point for buddy teams which would be dropped off at various intervals around the rim of the wheel. For the sake of simplicity, buddy teams would be dropped off on various roadways. Here they would be given a compass and map along with a bee-line compass bearing to the hub. The leader would be waiting at the hub with a bonfire and plenty of franks to roast. The distance from the rim drop-off points would vary, but this problem would not be too effective unless the minimum traveling distance from rim to hub would be at least one to two miles.

Problem No. 3 Line Orienteering

In line orienteering the course should be about 3 miles long. Along the course there should be a dozen control points. The participants copy a course from a master map which has only a continuous line from start to finish. It is then up to each participant or team to copy the line route

onto his own map. It is then up to each participant to correctly mark in the control points on his map as he covers the route. The control points may be marked on the map with a small circle. The score calculation is done by simply measuring the distance between the correct position of the control on the master map against where the participant has marked the control on his map. Two points may be deducted for each 2 mm of incorrect distance.

Problem No. 4 The Equilateral Triangle

This is a good game for beginners. Place five 2 by 2 stakes in a row, each stake being about three feet apart. Number the stakes one to five. Have each person or buddy team start at one of the stakes. Each team is given any degree reading less than 120 degrees and are instructed to walk along the given azimuth for two hundred steps. At this point, they add 120 degrees to their first reading, reset the compass, and walk another two hundred steps in the new direction. At this point they add another 120 degrees to the second reading, reset the compass, and walk another two hundred steps in the third direction. If they are on course, they should be over the stake from which they started.

Problem No. 5 Rendezvous at Base Camp

A buddy team or small group is given a topographical map and a compass. They are instructed to follow a trail which has been marked on the map to a definite control point. This control point should be an obvious landmark such as a bridge. When they get to this control point they are to search for a marked envelope which will contain further instructions. In the envelope will be a card listing a true compass bearing they are to take, and the approximate distance to the second landmark. The trail to the second landmark is not marked on the map. When they get to the second landmark or control point they are to look for a second envelope containing further directions. The second envelope contains instructions to follow a bee-line magnetic azimuth until they reach a base campsite where lunch will be waiting. For best effect, this should be about a two hour problem.

THE COMPASS AS A WATCH

With a compass you can tell approximately what time it is. The sun moves 15 degrees in one hour (360 degrees in 24 hours). Figure 283-A will show you the bearing of the sun at any hour of the day. This is how you use your compass as a watch:

1. Place your compass on a level surface in the sun.
2. Turn the compass or compass housing until its "S" is exactly above the north end of the magnetic needle. See Figure 283-B.
3. Place a pencil, matchstick or other thin straight object upright over the middle of the compass housing as shown in Figure 283-C.

4. The shadow of the upright will indicate the bearing of the sun, and by referring to Figure 283-A you will know the approximate time.

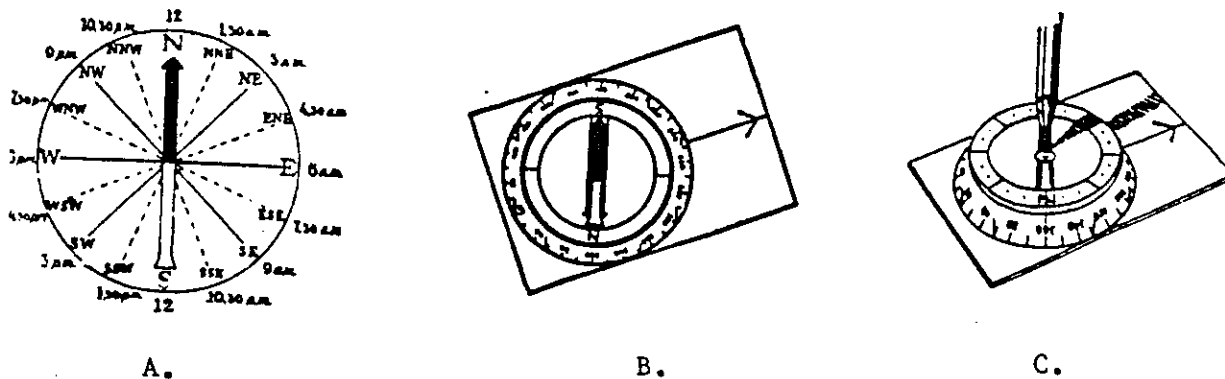

Figure 283 Using the Compass as a Watch

THE MAGNETIC POLES

Before leaving the subject of the compass, let us quickly review the phenomenon of the magnetic poles.

A compass needle is nothing more than a bar magnet with a north and south pole. All magnets have magnetic fields represented by lines, called "lines of force".

The region in which the lines of force enter the magnet is called the south pole, and the region in which they leave the magnet is called the north pole. Thus, the lines of force are directed from south to north within the magnet, and from north to south in the external field. Every magnet has a north pole and a south pole. A single pole cannot exist independently. If two magnets are brought close together, unlike poles attract each other and like poles repel. Thus, a north pole attracts a south pole but repels another north pole.

The earth itself has a magnetic field, with its magnetic poles being some distance from the geographical poles. If a permanent bar magnet is supported so that it can turn freely, it aligns itself with the magnetic field of the earth, which at most places is in a general north-south direction. Since the north pole of a bar magnet (or a compass needle) points in a northerly direction, the earth's magnetic pole in the northern hemisphere has "south" magnetism. Nevertheless, it is called the north magnetic pole because of its geographical location. For a similar reason, the pole in the southern hemisphere, although it has a "north" magnetism, is called the south magnetic pole. To help avoid confusion, north magnetism is usually called "red", and south magnetism, "blue". The red or north pole of a magnet is usually painted red, and in some cases the south or blue pole is painted blue. The north magnetic pole of the earth is a blue pole and the south magnetic pole is a red pole.

CHAPTER 10

RAFTS AND FLOATATION DEVICES

GENERAL

The man who has never had the opportunity to build a raft when he was a boy has missed a real experience. There is a marvelous satisfaction in pushing-off with your own raft.

Certainly rafts are not the safest and best mode of transportation, but there is a lot of fun and excitement to be had with a makeshift raft on a pond or stream. Rafts are also useful to shuttle equipment by securing the raft fore and aft with ropes tied to each shore.

Rafting rivers is one of the oldest forms of water travel and often it is the quickest method of crossing a water obstacle. You may use downed trees, brush or most anything that is floatable.

The types of expedient floatation devices that can be devised are limited only to an individual's ingenuity. Everything from a large pneumatic raft that will carry several people to an individual's trousers can be used to help keep afloat while crossing short spans of water. Some of the more common rafts and floatation devices are graphically shown in Figures 286 - 307.

BUOYANCY AND DRAFT

Perhaps the main thing to remember about any raft or floatation device is the thing that makes them float is water being displaced. Buoyancy is the tendency of a body to float or to rise when submerged in a fluid. To support a weight, an amount of water equal to that weight must be displaced. A good rule to follow is to give the raft enough buoyancy to carry only half of the weight load.

In nautical terms, the draft is the distance between the lowest part of a boat or raft and the water line. In other words, the shallower the draft, the higher the raft will ride in the water. This is important because the higher the raft rides in the water the easier it is to maneuver. Buoyancy parts must be spread out evenly so the raft will not dip on one side or the other with the weight of the passengers.

CROSSING A SWIFT STREAM

Before getting directly into the subject of rafting, we might say just a few words about crossing streams on foot. Sometimes you may choose

to wade a swift stream rather than trying to use a floatation device. In this event, a stout pole, for use as a brace, will help you cross a shallow swift stream. See Figure 284. If the current is slow and the bottom rocky, keeping your body submerged will take most of the weight off your feet and reduce the danger from bruises and losing your footing.



Figure 284 Crossing a Shallow Swift Stream with the Aid of a Stout Pole as a Brace

Cross deep swift currents by swimming diagonally downstream. In flat country the outsides of river bends generally have steeper banks and deeper and swifter water than the inner curves. Cross diagonally and strike the inside bend where the water is apt to be slack and shallow. Often the current is slow and shallow at the widest part of a stream. Just above a riffle, water is generally shallow.

Figure 285 shows another method of using a strong pole to aid one person or more who are fording a swift stream by using a pole to "break the current."

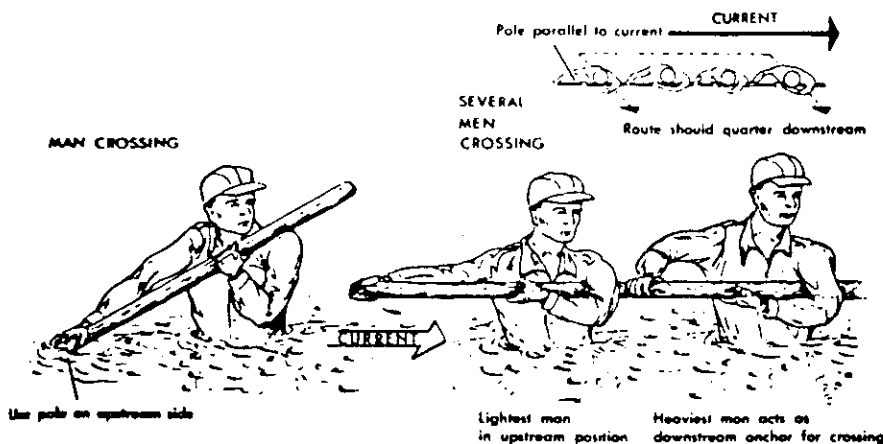

Figure 285 "Breaking the Current" on a Treacherous Stream with a Strong Pole

The pole should be about 5 inches in diameter and about 7 or 8 feet long. Use the pole on your UPSTREAM side to break the current. Do not use it on your downstream side where the current tends to push you down on the pole and to lift your feet from under you. Keep the pole grasped firmly on your upstream side and firmly plant your feet with each step. Lift the pole a little ahead and downstream from its original position but still upstream from you. Step below the pole. Keep the pole well

slanted so that the force of the current keeps the pole against your shoulder. Several people entering a swift ford should follow the procedures already mentioned.

The pole is used differently when there is more than one person. The HEAVIEST person forms the DOWNSTREAM anchor with the pole held PARALLEL to the current. The LIGHTEST person is placed at the UPSTREAM end of the pole where he breaks the current; those below move in the eddy formed by his body.

If the current comes from the right, grasp the pole under the left armpit with the right hand extended for balance. If the current comes from the left, grasp the pole under the right armpit and extend the left hand for balance.

At times the upstream person may be temporarily swept from his feet, but the eddy formed by his body enables the people below him to move with comparative ease.

As in all fording, the route should quarter downstream. Currents too strong for one person to stand against usually can be crossed safely in this manner.

Experience can enable you to judge water and the swiftness of its flow with great accuracy, but there is always danger in fording. Take all possible precautions for your personal safety and that of your equipment.

Do not worry about having a heavy pack on your back, since nothing helps more in swift water than weight - IF you can release it quickly. Indians used to shoulder heavy stones to help them to keep their footing in swift streams. The weight of your pack makes it inadvisable to complicate matters further with heavy stones, but REMEMBER THAT THE WEIGHT OF A PACK IS A HELP AND NOT A HINDRANCE.

If the person crossing is a poor swimmer, or if the stream is wide, perhaps it is best to use some sort of raft or floatation device.

SIMPLE FLOATATION DEVICES

1. Trousers Water Wings

One simple type of floatation device may be to use a pair of trousers as water wings. These are effective for shorter stretches of water. The use of trouser water wings is shown in Figure 286.

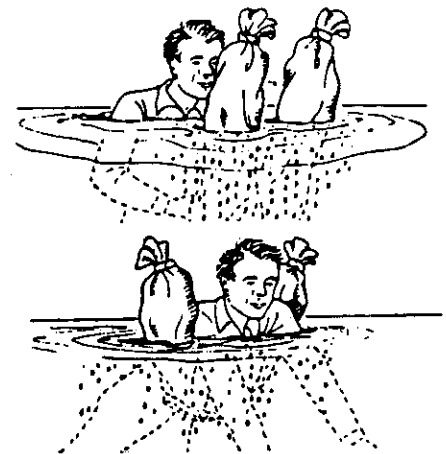

Figure 286 Using Trousers as Improved "Water Wings"

2. Empty Plastic Jugs

Figure 287 shows a method of using four to six one gallon empty plastic jugs as a float. When the jugs are tied together, the ropes could be placed across the chest and under the armpits. This simple type of improvisation could do a lot to help a tired or poor swimmer.

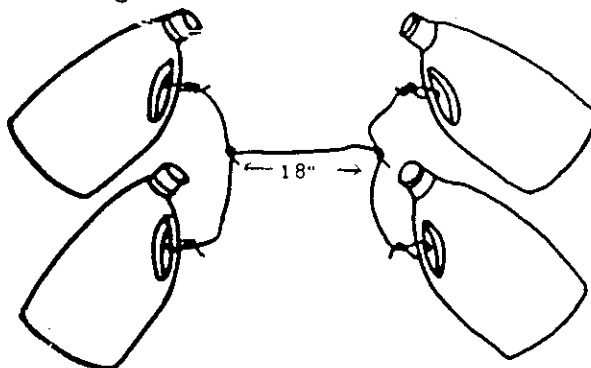

Figure 287 Making a Floatation Device with Empty Plastic Jugs and a Rope

3. The Canteen Float

Another method, if canteens were available, would be to attach several well stopped empty canteens onto a belt or rope and strap the belt around the chest. With eight empty canteens, a weak swimmer would be able to float his body in the water. See Figure 288.



Figure 288 An Improvised Canteen Safety Belt

4. A Poncho Life Belt

Still another method of making a floatation device would be to make a plastic or poncho life belt. See Figure 289. If

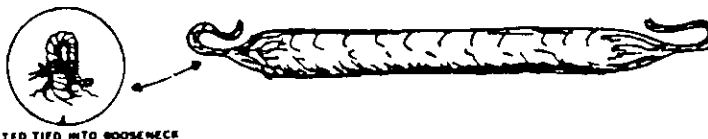

Figure 289 Improvised Floatation Life Belt

green vegetation is rolled tightly inside of a poncho or piece of plastic and the ends twisted into a pig tail and the pig tail ends folded back over itself and tied so as to make it water tight, an improvised life belt will result. The poncho or plastic should be started and rolled the same way the roll is begun for the Australian Poncho Raft (See Figure 299). The roll should be about 8 inches in diameter and approximately 3 feet long, depending on the size of the individual's torso. If this were worn around the waist or thoracic cage, or it could be worn across one shoulder and under the opposite arm like a bandolier, such a belt would support a person in the water.

5. The Lone Log

One more type of floatation device might be to use one large light log. This could be used to hang on to and paddle and steered by a person, or it could be ridden horseback style as in Figure 290.

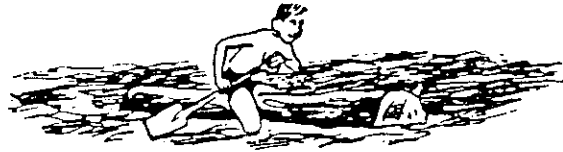

Figure 290 The Lone Log Floatation Device

6. Pneumonic or Inflatable Rafts

Rubber rafts were developed during World War II primarily for ocean rescue and survival. Since then, many planes, boats and rescue teams carry pneumatic rafts. Some of these are elaborate 20 passenger rafts which are self inflatable with the pull of a trigger. Some multiplace rafts have buoyancy tubes separated into chambers. Many of these more expensive rafts are made of tough durable fiber and are built to withstand the punishment of really fast waters.

The cheaper inflatables are more simple and have to be filled with a pump or by mouth inflation. Air chambers should not be over-inflated. They should be well rounded but not drum tight. Confined air will expand during the heat of the day. This could cause a "blowout." This is one reason that it is always good to have several separate air compartments. With the cheaper rafts, one must be careful not to snag the raft on roots or stumps.

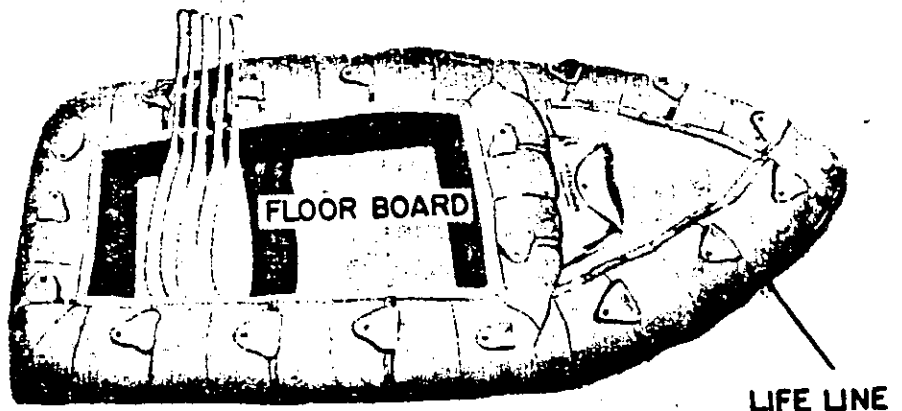

Figure 291 A Five-Man Pneumatic Canvas Raft

Sometimes it is a good idea not to wear heavy shoes while in the raft. When sitting in the raft one should keep his body low and standing up is a definite no-no. Keep knives, fish hooks, food tins, etc. off the surface of the raft in order to help prevent punctures or cuts. If leaks occur, they are most likely to occur at the valve stems and seams. If leaks occur on the surface, they can be patched fairly easily, so a good repair kit should always be along with the raft. Air rafts are bulky but they are light weight. They weigh about as much folded up as they do when filled with air. As a rule, they are a good little raft to use on inland waters when kept reasonably close to shore. Smaller inflatables are difficult to control in the wind so one must not get out too far on a lake.

Another point to remember is that deterioration of the rubber fabric, due to age, weathering and poor care, often make older rafts risky. One type of pneumatic raft is shown in Figure 291.

7. The Inner Tube Raft

A one-man tube raft can be easily assembled with two to four truck tire inner tubes. If you use only two tubes the raft will not be too stable, but it makes a good way to cross a creek or narrow body of water. A deck can be improvised with a board big enough to cover both tubes or small poles can be lashed to the tubes. For locomotion, a push pole may be used by a person in the sitting position or a double paddle may be used. The rider must be able to balance himself fairly well.

Sometimes, one larger inner tube may be carried in a pack along with a small air pump. When the raft is in use, a tow line may be attached to each side of the raft and the free ends anchored on each side of the creek. In this manner, equipment and perhaps one person at a time could be ferried back and forth. Again, a piece of board or a small piece of canvas could be attached to the tube for decking.

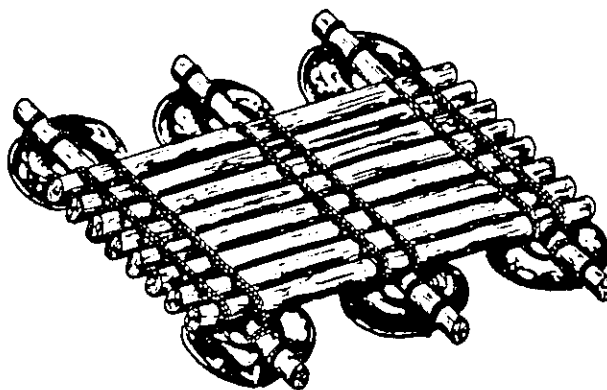

Figure 292 An Inner Tube Raft

8. The Barrel or Oil Drum Raft

Old water tight barrels or oil drums make good floats for rafts. As with inner tubes, the trick is to make the frame fast to the barrels and of course, spreading out the barrels is usually better than having them too close together. A shallow draft makes the raft ride higher so this must be kept in mind along with the weight of the decking. A barrel raft should have enough buoyancy to carry only half of the loaded weight so that the barrels will be only half submerged.

One of the most buoyant things for a raft is a container of air. The weight and volume of air are closely related so it would be worth remembering the following:

- 1 gallon of water equals 8.34 pounds
- 1 gallon of water equals 231 cubic inches
- 1 cubic foot of water equals 62.4 pounds
- 1 cubic foot of water equals 1728 cubic inches
- 1 cubic foot of water equals 7.48 gallons

As you can see by the above measures, a ten gallon barrel will sink with a hundred pounds of weight. Four 15 gallon drums will support a raft with a light frame and 2 medium sized men. From this basic information you can build almost any type or size of raft with barrels. Push poles usually work better than trying to propel the raft with paddles. If two sizes of barrels are used, use the smaller barrels as outriggers. Figure 293 shows a well built barrel raft.

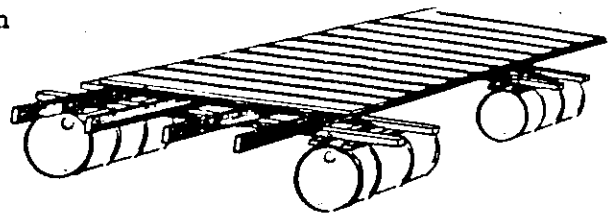
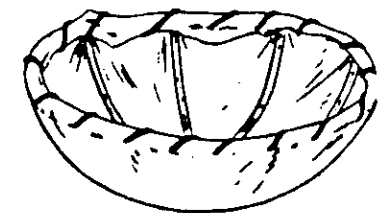
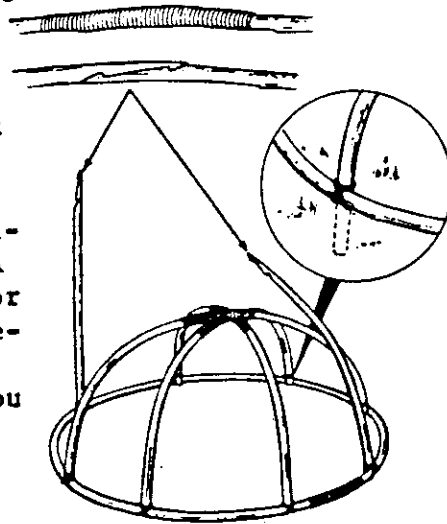

Figure 293 The Barrel or Oil Drum Raft

9. The Bull Boat

Figure 294 illustrates how to make a bull boat from young saplings and a piece of canvas. It goes without saying that a raft of this type is not for long trips but instead it is a "fun" raft for experimentation and pleasure. A double paddle is needed for locomotion in order to prevent spinning around, but with a little practice, you can cover a short span of water surprisingly fast. It makes a good emergency raft if nothing else is available.



An emergency boat can be made by stretching a tarpaulin or light canvas cover over a skillfully shaped framework of willows and adding a well-formed keel of green wood, such as slender pieces of spruce.

Attach gunwales (sides) of slender saplings to both ends and equalize the spreaders or thwart as in a canoe. Tie ribs of strong willows to the keel, bend the ends of the ribs upward and tie them to the gunwales. Closely cover the inside of the frame with willows to form a deck upon which to stand.

Such a boat is easy to handle, buoyant, and lacks only strength to be suitable for long journeys. This boat is entirely satisfactory for ferrying a group across a broad, quiet stretch of river.

When such a boat has served its purpose, remove the canvas cover and take it along for constructing shelters or making other boats.

Figure 294 The Bull Boat

Using Brush for Rafts

Another buoyant material that can be used for rafts is green or dried brush. Brush can be tied up into bundles or bags, it can be wrapped in plastic or canvas, or it can be used in any way that your imagination directs. A few of the methods of making brush rafts are listed below:

10. The Brush Boat Raft

The brush boat raft is used for hauling equipment, gear and supplies. It is not used for transporting personnel. It is nothing more than a rectangular shaped canvas with the corners drawn up and tied together so as to form a rectangular shaped box as shown in



Figure 295 The Brush Boat Raft

Figure 295. The canvas container is then filled with tightly packed green or dried brush. With a pull rope fastened on either side of the raft and with the free ends anchored on each bank, the raft may be easily pulled back and forth over a stream or creek.

11. The Brush Raft

Another type of brush raft that can be made fairly easy with two ponchos, a couple of pieces of canvas or plastic, is shown in Figure 296. Lay a 10 x 10 foot piece of plastic or canvas on the ground. Pile freshly cut green brush (avoiding thick branches and heavy stalks) about 18 inches high on the canvas. Place an "X" frame of small saplings such as the one shown on the Sausage Raft in Figure 298 on the brush. This will make the raft more rigid. Another 18 inches of light brush is then placed on top of the "X" frame. The sides of the canvas are then brought up and around the pile and the sides of the canvas are held tightly together by threading a rope crisscross through the grommets of the canvas. In the event grommets are not present, small stones may be placed in the folded edge of the canvas or plastic. These stones may be held in place by one end of a piece of small rope or twine, the opposite ends of which are then carried back and forth to all sides of the plastic forming a tied bundle. The second piece of plastic or canvas is then laid out on the ground next to the brush package. The bundle is then turned over and laid on the center of the second canvas. The sides of the second canvas are then wrapped up and around the bundle and fastened together as was done with the first canvas. When lifting into the water, take care not to puncture or snag the coverings.

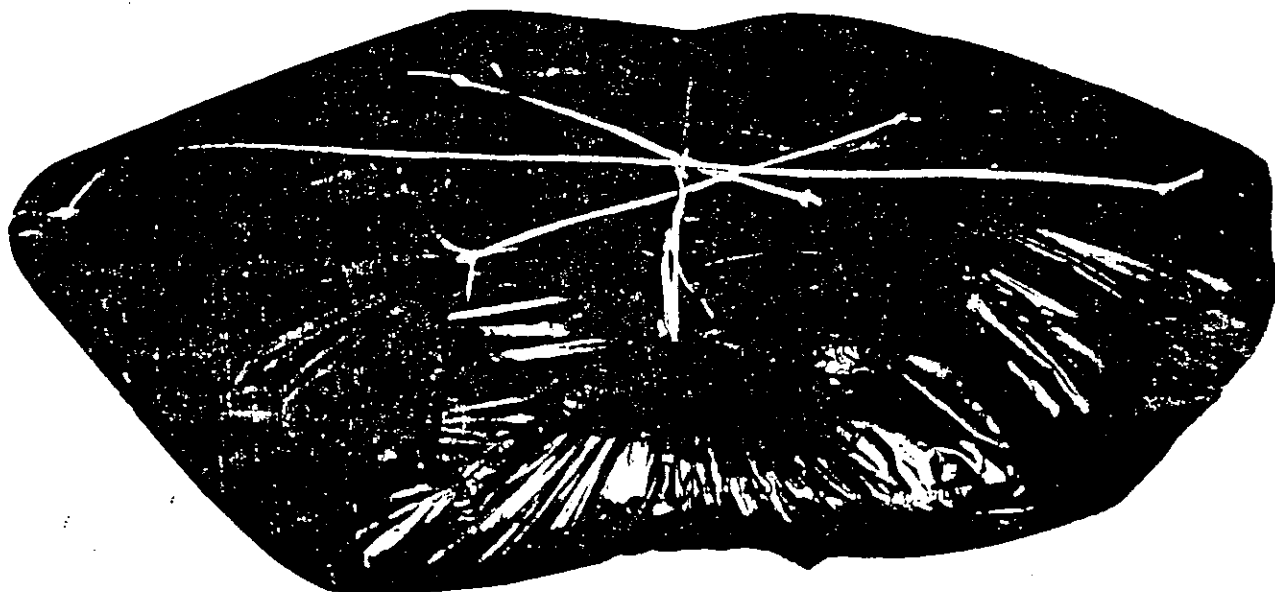
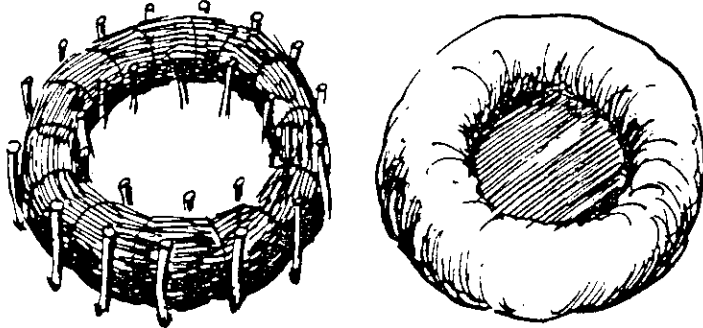

Figure 296 The Brush Raft

12. The Coracle

- a. Knock two concentric circles of stakes into the ground, the outer ring having a radius of about 2 ft. 6 in. (this will give a circumference of about 20 feet).
- b. Pack in brushwood and bind with sisal string.



- c. Place on canvas, old groundsheet or tarpaulin and tie in position, put a mat in the bottom, make a paddle and you're away!

Figure 297 The Coracle

The coracle is another form of brush raft which is clearly illustrated and explained in Figure 297. Being doughnut shaped, this raft works best with a double paddle to prevent spinning.

13. The Sausage Raft

Still another type of brush raft is the Sausage Raft shown in Figure 298. Again, pieces of plastic or canvas can be used for each of the six to eight "sausages" that you make depending upon the diameter and length of the sausages. These should be fairly good size (12 inches in diameter by 6 feet long). The sausages may be packed with brush, hay, straw, dried weeds or almost anything that is lightweight and gives a little rigidity. This material is packed into the sausage roll and, of course, the main thing is to make the roll as watertight as possible. You might make the sausage in the same manner that is used in the Australian Poncho Raft in Figure 299. After each sausage is tied up and made as watertight as possible, an "X" frame of smaller saplings, as shown in the figure, is placed on the bottom as well as the top of the raft. It is also necessary to tie each sausage on to the frame individually in order to make the raft more secure.



Figure 298 The Sausage Raft

14. The Australian 2 Poncho Raft

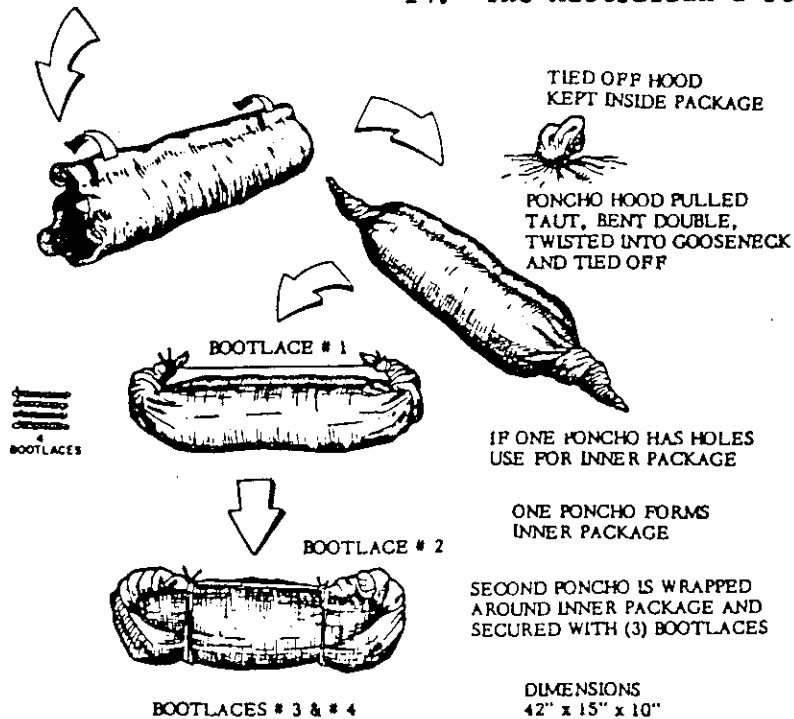

The Australian 2 Poncho Raft is clearly illustrated and explained in Figure 299. The idea for this raft came from the Australians during World War II. This type of raft uses personal gear rather than brush as the buoyant factor. You should stow enough personal gear to make a package about 42" x 15" x 10". This will easily float one man along with his gear in the parcel. If you have no personal gear you could use empty tin cans as another type of buoyant material.

Figure 299 The Australian 2 Poncho Raft

15. The Ice Raft

In the northern regions, during the winter, it is even possible to make and use an ice raft. Large streams and small rivers may be open in the middle because of the currents. Large ice blocks may be cut into rafts. The size of the rafts should be about 6 x 9 feet and the ice should be at least one foot thick. A push pole should be used for locomotion.

16. The Catamaran

A Catamaran is a raft with twin hulls made from logs and fastened together by a wooden platform. A couple of push poles or paddles are needed for locomotion. The materials needed for this raft include two dead logs between 17 and 20 feet long. They should be 12 inches or more thick

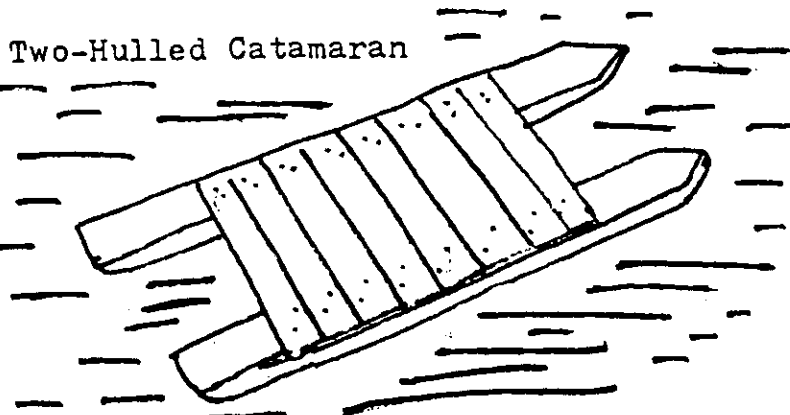

Figure 300 A Catamaran

at the butt ends and, of course, the logs should not be waterlogged. For the platform or deck you can use one inch planks, or if not available, you can use 2 - 3 inch saplings. The platform should be about 10 feet long and 4 feet wide as shown in Figure 300.

To build, first clean up the logs and flatten the tops of the logs with a drawknife. Point the logs at both ends. If the raft does not ride high enough on the water, a third log must be placed in the center and parallel to the other two logs.

If desired, a sail or an outboard motor support may be added. If a sail is used on a catamaran of this size, allow about a ten foot mast with an eight or nine foot boom. Another added feature which will make for more comfort is the addition of a canopy over part of the deck. This is done by boring two holes on each side of the deck and putting uprights in the holes. From the tops of the uprights a frame may be built which can be covered with a tarpaulin or piece of plastic.

The catamaran originated in the Fiji Islands. It makes an excellent raft, it is inexpensive to build and the fun of drifting down a river is worth the effort of building it.

17. The Log Raft

Perhaps the most common raft and easiest to build is the log raft. A float of logs fastened together is the "Pioneer Boat". Logs can be a variety of sizes but the larger and drier the logs the better the raft will float.

Perhaps the easiest log raft to build is the "Triple Six Log Raft." This raft, as seen in Figure 301, consists of 6 logs 6 feet long and 6 inches in diameter, and will support one person. The logs are laid side by side and may be held together with lashing ropes or baling wire on each end of the logs. To make the raft more comfortable, it could be finished off by nailing planking across the logs to form a solid deck instead of using the lashing ropes or wire. Again, a couple of paddles or a push pole will give the needed power. This raft is excellent for crossing streams, moving around the shorelines of lakes and short river trips.



Figure 301 The "Triple Six" Log Raft

Another method of holding several logs together would be to use "pressure bars." This would consist of 4 poles from 2 to 3 inches in diameter laid at right angles to the main floatation logs. They would be placed both on top and at the bottom of each end of the logs. The logs would have to be slightly notched to accept the pressure bars and the

pressure bars would have to be notched on both ends to accept the lashing ropes. See Figure 302-A and 302-B. For average use in slow water, pressure bars could be spiked to the logs instead of lashing them. Heavy metal spikes could be used or if the logs were of extremely soft wood, improvised hardwood spikes could be used as shown in Figure 302-B.

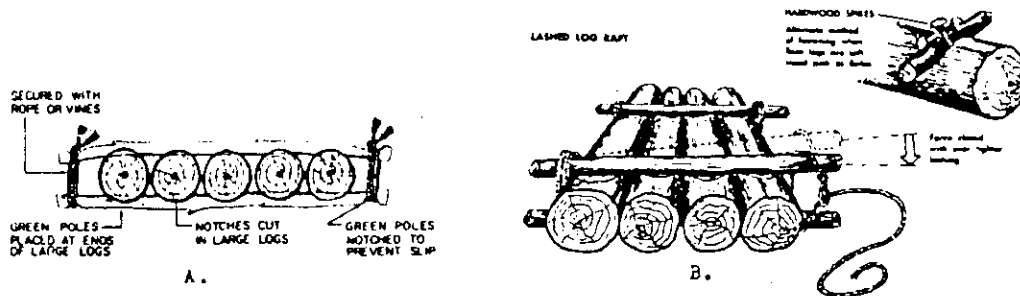

Figure 302 Use of Pressure Bars

WATER DISPLACEMENT BY LOGS

As mentioned under the heading of "Buoyancy and Draft", we said that water will support a boat or raft if the volume of water displaced by the craft is equal to the weight of the craft and the passengers.

One method you can use as an aid in figuring out the number of logs needed is as follows:

Let's say that you want to build a raft 10 feet long and you have a good stand of pine conifers with a lot of good deadwood. So, you collect several logs 10 feet long and all of them have a diameter of about 8 inches. The formula for obtaining the volume in cubic feet of any cylinder is to multiply the radius by itself times pi (3.1416 or roughly 22/7) times the length of the log. In this case, the radius of 4 inches equals 1/3 of a foot, therefore:

$$1/3 \times 1/3 = 1/9 \times 22/7 = 22/63 = .35 \times 10 = 3.5 \text{ Cubic Feet}$$

One log, then, will displace 3.5 cubic feet of water. One cubic foot of water weighs 62.4 pounds. So, if you multiply 3.5 times 62.4 we get 218.40 pounds, which is the weight of the water one log will displace.

The 8 inch pine log will weigh (if perfectly dry) 25 pounds per cubic foot. Thus: 3.5 times 25 will equal 87.5 pounds. Subtracting this figure from the weight of the water displaced (218.40 pounds) leaves 130.9 pounds which is the weight that the log will support in the water.

Now, this much weight would make the log ride very low in the water. Secondly, if the timber was not completely dry or if it became waterlogged after being in the water, it's own weight would increase well beyond the 25 pounds per cubic foot. Then let's say that you want the raft to carry 500 pounds of people weight. This means that you must have a good safety

margin. The 130.9 pounds of buoyancy per log probably would be cut to about 2/5 of that figure. 2/5 of 130.9 equals about 52.4 pounds. Assuming that this figure would be close, it would take about 10 logs (52.4 x 10 = 524 pounds) to support the total weight and still allow the raft to ride with a shallow draft. This would also give it enough width to prevent tipping.

BUILDING A LOG RAFT

We have already discussed the fundamental building of the Triple Six Raft and the use of pressure bars. Now a few more words about building rafts.

After dry poles have had the branches lopped off and the trunks debarked, the timbers should be cut to length trying to keep logs of the same size. The logs should be laid together alternating them end for end so that both ends of the raft will be about the same size.

Two methods of constructing a raft: If only baling wire or rope is available, crossbars are lashed to logs, and diagonal brace is lashed to crossbars to keep raft rigid.

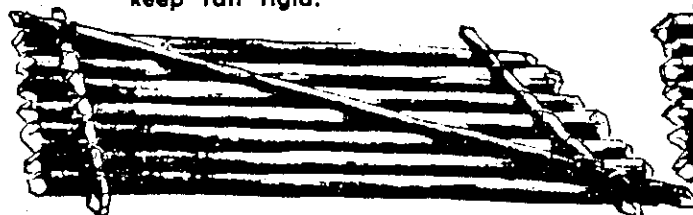

Figure 303-A Use of a Diagonal Support

If spikes are handy, logs can be notched for crossbars, which are themselves notched to allow for deeper penetration of the spike

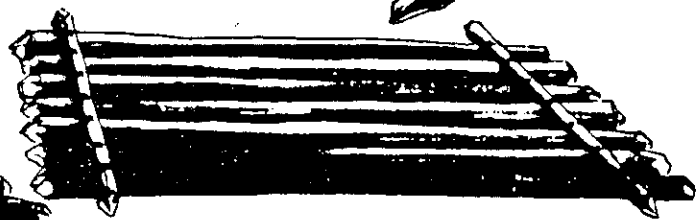
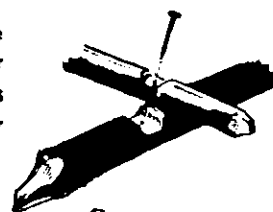

Figure 303-B Using Metal or Wooden Spikes

The timbers can be joined together by spiking on a deck or the logs can be held together by lashing ropes, wire or pressure bars. Still another way would be to use three 2 to 4 inch poles as crossbars at each end of the raft and then a diagonal may be put in for support (if needed) as shown in Figure 303-A. If desired, these crossbars may be spiked to the floatation logs. In this event, the diagonal pole may not be needed. If the logs should be extremely soft such as balsa wood, hardwood spikes should be used, as shown in Figure 303-B.

If desired, a sail can be rigged on a raft as shown in Figure 304.

If you will be hauling a lot of gear, it should be wrapped in waterproofed material and tied to the center of the raft.

Building a larger raft for swift water and long trips becomes a more difficult task. Rope quickly wears out from frequent rough contact with rocks and gravel. Spikes are not satisfactory since they can pull or twist out easily in rough water. A raft must be strong enough to

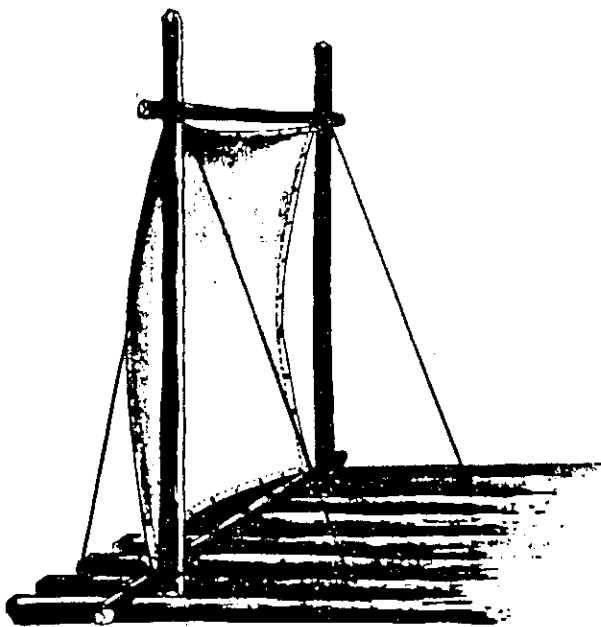

A sail can be rigged on a raft to take advantage of prevailing winds. Uprights are spiked to the crossbar and guyed with ropes on either side. Top crosspiece, lashed to uprights, prevents them from spreading. A tarp makes a suitable sail, and it can be spiked or tied through grommets at the four corners.

Figure 304 One Method of Rigging a Sail on a Raft

Build the raft on two skid-logs placed so that they slope downward to the bank. Smooth the logs with an axe so that the raft logs lie evenly on them. Cut two sets of slightly offset inverted notches, one in the top and bottom of both ends of each log. Make the notches broader at the base than at the outer edge of the log, as shown in the illustration. Use small poles with straight edges or a string pulled taut to make the notches. A three-sided wooden crosspiece about a foot longer than the total width of the raft is to be driven through each end of the four sets of notches.

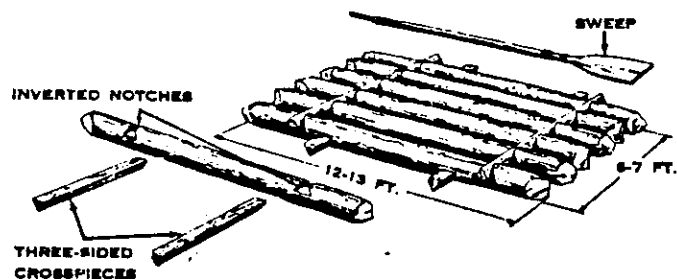

Figure 305 A Rugged Log Raft Developed by Northern Woodsmen

withstand the buffeting it may have to take from rocks and swift water.

Northern woodsmen have developed a construction method for a more rugged raft that is superior in strength and endurance. All that you need are good straight logs all about the same size, an axe and a sheath knife. However, a saw and a rope would be very useful, and I'm sure it goes without saying that experience would be very beneficial. This raft is seen in Figure 305.

A raft for three men should be about 12 feet long and 6 feet wide, depending on the size of the logs used. The logs should be 12 to 14 inches in diameter and so well matched in size that notches you make in them are level when crosspieces are driven into place.

Complete the notches on all logs at the top of the logs. Turn the logs over and drive a 3-sided crosspiece through both sets of notches on the underside of the raft. Then complete the top set of notches and drive through the two additional sets of crosspieces.

You can lash together the overhanging ends of the two crosspieces at each end of the raft to give it added strength; however, when the crosspieces are immersed in water they swell and tightly bind the raft logs together.

If the crosspieces fit too loosely, wedge them with thin, boardlike pieces of wood split from a dead log. When the raft is in water, the wood swells, and the crosspieces become very tight and strong.

Make a deck of light poles on top of the raft to keep packs and other gear dry.

A raft of this type may have to be steered with sweeps and poles from both ends of the raft. In navigating unfamiliar swift rivers, it would be a good idea to scout the river beforehand for rapids, sweepers and falls.

A RAFT USING PENDULOUS ACTION

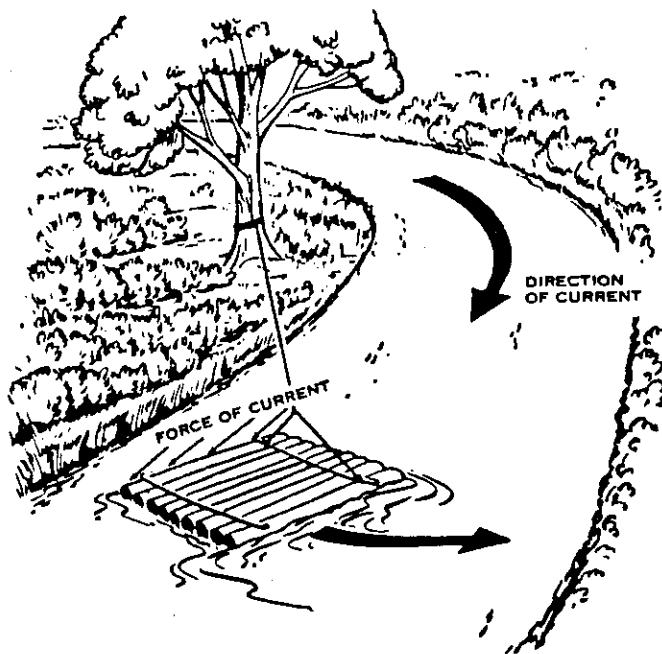

Figure 306 A Raft Using Pendulous Action

Another fun thing to try is using a raft utilizing pendulous action. This has to be initiated at a bend in the river as shown in Figure 306. A rope must be anchored to the inside bank of a swift moving stream. This rope must be as long as 8 times the width of the river or stream. To start, the raft must be canted to the direction of the current. The attachment of this rope to the rope on the raft must be as illustrated in Figure 306. The attachment of the rope on the raft must be adjustable to change the cant of the raft to allow it to return to the starting bank.

THE FLYING FERRY

The Flying Ferry shown in Figure 307 is another interesting type of crossing. This type of crossing works on the same principle as the one above. This also has to be used where the current is fairly swift. The raft is held in the stream by an anchor well upstream from the crossing site. The rope from the anchor to the raft

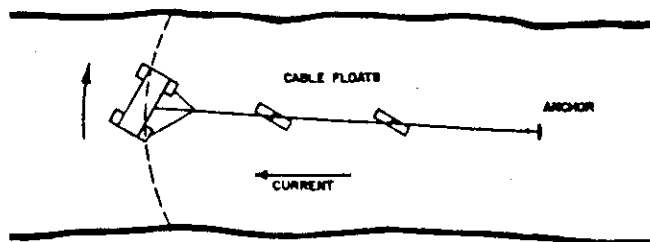

Figure 307 The Flying Ferry

must be twice as long as the width of the stream. The rope attachment to the raft is the same as in Figure 306. The anchor rope should be kept clear of the water with necessary floats. As the ferry moves from shore to shore, it makes an arc, the center of which is the anchor. To start, the raft must be canted in the right direction and the raft must be maintained in a canted position to the flow of the current so the raft will drift to the far shore. The force of the current acting against the cant or angle of the raft propels the raft from shore to shore.

RAFT SAFETY RULES

1. Travel rivers only when it is light.
2. Use a pole to move the raft in shallow waters - in deeper waters use a paddle, double paddle or an improvised oar.
3. Keep near the shore when on a lake.
4. Do not go to sleep on a raft.
5. Keep on the lookout for snags, sweepers and rapids.
6. Only experienced rafters should try fast water.
7. Do not overload the raft.
8. Keep equipment and gear tied down.
9. As a general rule, be sure that your raft has a shallow draft. However, with a favorable current and an unfavorable wind you can get farther by keeping the raft and yourself as low in the water as possible. If the wind is favorable, ride high by lightening the raft as much as practical and you might think about hoisting a makeshift sail.
10. If a raft is going to be used for extended periods of time, be sure to check the construction of the raft periodically (air leaks, waterlogging, condition of spikes, wire, or rope lashings etc.)

CHECKING THE RATE OF SPEED OF A STREAM

If you would like to check the average rate of speed of a current in a narrow stream or river, you may try this: From a starting point on a relatively straight part of the stream, measure off a 100 foot distance along the stream. Toss a small chip into the current at the

starting point and note how long it takes the chip to go the one hundred feet. Lets say that it takes 30 seconds for the chip to float the 100 feet. This means that in one minute the surface water goes 200 feet. In an hour the surface water would go (200 x 60 minutes) 12,000 feet. Dividing 12,000 by 5,280 feet would equal 2.27 miles per hour which would be the speed of the surface water. Approximately $\frac{4}{5}$ of that figure ($\frac{4}{5}$ of 2.27) will give you the average rate of flow of the stream as a whole. This would be roughly 1.8 miles per hour.

CHAPTER 11

FIRES, FIRE LAYS AND FIREPLACES

THE FIRE TRIANGLE

Another craft of the out-of-doors is fire building. In order for a fire to burn, three things are required: fuel, heat and air. This is known as the fire triangle. In order to make a fire burn, we need air to provide oxygen for the burning process; we need enough heat to bring the fuel to ignition; and of course, we need some sort of fuel to keep the fire going. When one of these three things are taken away, the fire triangle is broken and the fire goes out. See Figure 308.

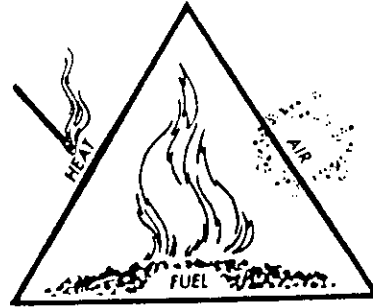

FOR A FIRE TO BURN, THREE THINGS ARE REQUIRED:
FUEL - SOME KIND OF MATERIAL THAT WILL BURN.
HEAT - ENOUGH HEAT TO BRING FUEL TO IGNITION.
AIR - TO PROVIDE OXYGEN FOR BURNING PROCESS.

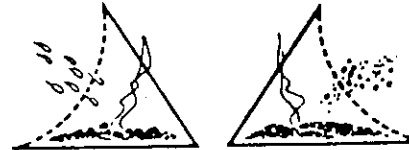

WHEN ONE OF THE THREE THINGS IS REMOVED, THE FIRE STOPS BURNING. WATER COOLS FUEL BELOW IGNITION POINT, DIRT CUTS OFF THE OXYGEN SUPPLY.

Figure 308 The Fire Triangle

NEEDS FOR FIRE

Fire is needed for a variety of things such as cleanliness, heat, cooking, light, safety, drying, melting, signalling, purifying water and a host of other things.

Some fires can be built in such a manner that they can be made more efficacious than others. Certain fires can be built that are much better for drying, heat, light, cooking etc. Therefore, it is nice to know some of the different methods of building fires so one can build the right fire for the right purpose.

TIPS ON CAMPFIRES

1. Before building a fire, find a site at least ten feet in diameter which is clear of tinder, ground cover, overhanging branches and anything that will burn. Build the fire in the open.
2. Get everything ready before you light the fire. Have enough tinder, kindling and fuel to sustain the fire. Make a good fire lay and have it ready to light.

3. Rock, sand, or gravel usually makes the best base for a fire.
4. Keep fires away from trees and stumps.
5. Usually a small fire is better than a large fire.
6. Have a dirt pile or a pail of water ready to douse the fire if it should get out of control.
7. Split wood burns better than unsplit wood.
8. In wet weather, search for tinder in the inner bark of trees, or use pine cones, squaw wood or carry a fire starter. Kerosene soaked sawdust in a water tight can makes a good fire starter or pouring hot wax over sawdust which has been placed into blocks of some sort and allowed to dry makes another good fire starter.
9. Proper draft is necessary for a good fire. Elevating a fire usually produces a better draft. Get into the habit of using "damper sticks."
10. Another handy item to have with you when starting campfires is an "expirator tube." This is nothing more than a two foot long plastic or rubber tube about a half inch in diameter which is carried for the purpose of giving an excellent draft to a stubborn fire. If desired a small metal tube 3 to 4 inches long may be slid over the end of the tube that is put close to the fire. All one has to do is direct the metal end of the tube down into the fire and blow into the other end. This acts as a bellows and directs the draft right into the fire where it is needed. It works much better than huffing and puffing into the whole fire and it is easily carried in your pack.
11. Fire needs air. Do not pack the wood too tightly.
12. Generally, soft woods are better for quick flame and quick heat. Some of the best woods are basswood, alder, red maple and fir. Poorer soft woods for fire are cedar, spruce, tamarack, elm and poplar. Generally, hardwoods are used for lasting coals and longer heat. Some of the best hardwoods are hickory, sugar maple, ash, birch, hornbeam, and the oaks.
13. Have all of the food kettles ready before you start the fire.
14. Saturate the ground with water when you think the fire is out. Be sure the fire is put out completely before leaving!
15. If the ground is wet or covered with snow, insulate the fire from the wet ground with dry logs before starting your fire.

STARTING A FIRE

After you have found a suitable place for a fire you should decide which type of fire lay and fireplace that you want to make. Gather an ample amount of tinder, kindling and fuel.

Tinder is the material which bursts into flame when you touch a match to it. Natural tinders include such things as strips of birch bark from dead trees, the inner bark of dead red cedar, basswood or cottonwood trees, dried weed tops or dry grass, dry evergreen needles, and dried bird or mouse nests. Other tinders may include such things as paper, wood shavings, waxed cartons, cotton, gauze or fuzz sticks. A fuzz stick is a dry stick about a foot long and an inch in diameter which has been pointed on one end. While holding the pointed end against something solid,

whittle long thin shavings completely around and up and down the stick, leaving the shavings attached to the stick so that it looks like a Christmas tree. This is an old fashioned fire starter that you can set under a fire lay and light. It is not too practical unless you want a little practice with your knife. Bone dry tinder is perhaps the most important thing in getting a fire started.

Kindling is the material which catches the flame from the tinder and ignites the fuel. Some of the best kindling is small dry squaw wood, pine knots, heavy dry twigs and cardboard. Other pieces of small dry wood which is match to cigarette size usually suffice in getting the finger size fuel started.

Wood fuel should be divided into finger size, wrist size and then larger logs from dry standing deadwood. For quick flames use soft woods. For lasting coals use hard woods.

FIRE LAYS

A fire lay is a method of starting a fire with a pre-arranged plan for getting the fire ready to burn. There are several methods one might choose. The more popular methods are the tepee, the half-tepee, the lean-to, the fire-stick and the criss cross fire lays.

1. The Tepee Fire Lay

This fire lay is started by placing a ball of tinder on the fire spot and then leaning a circle of small kindling sticks around the tinder with heavier sticks put on last. This is built like an Indian tepee. Leave a small opening on the windward side to light the fire. See Figure 309.

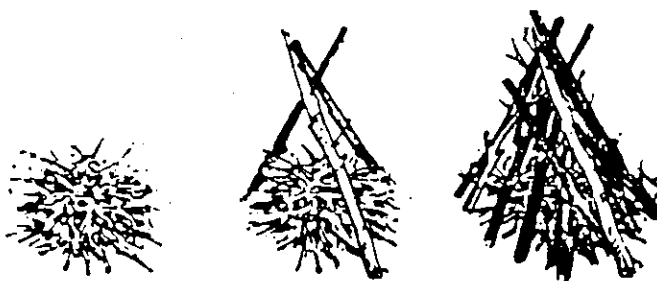

Figure 309 Tepee Fire Lay

2. The Half Tepee Fire Lay

This fire lay is made by laying a ball of tinder next to a large rock, log or wall of some sort. The small sticks are then leaned up against the wall over the ball of tinder. Small kindling sticks are placed first with the larger sticks on top. The tinder is then lit from one of the open sides. See Figure 310.



Figure 310 Half Tepee Fire Lay

3. The Lean-To Fire Lay

Push a green stick that is about 12 to 15 inches long into the ground on a slant with the point of the stick into the wind. Place a ball of tinder under the lean-to stick. Then lean the kindling against the lean-to stick from either side thus building a small "A" Frame. Place the fuel according to size against the kindling and light. See Figure 311.

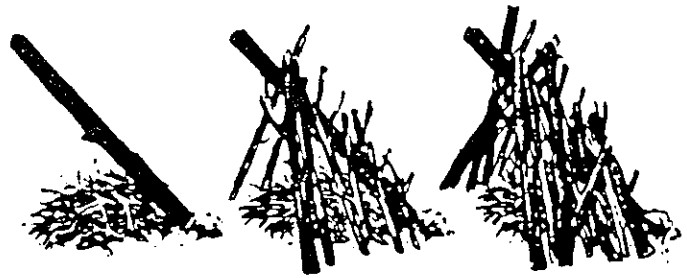

Figure 311 Lean-To Fire Lay

4. The Fire Stick Fire Lay

This is a good fire lay to use in a rock or log fireplace. A fire stick may be laid across the logs or stones with the ball of tinder underneath. Lean the kindling sticks against the fire stick on either side and build up the lay with ever increasing sizes of fuel. See Figure 312.



Figure 312 Fire Stick Fire Lay

5. The Criss Cross Fire Lay

This fire lay is for a quick bed of coals. Place two 12 inch sticks about 12 inches apart parallel to each other. Place a ball of tinder between them with the kindling on top of the tinder. Then put a couple of more sticks on top of and at right angles to the first two laid and build a criss-cross arrangement of sticks with the smaller sized sticks at the bottom. See Figure 313.

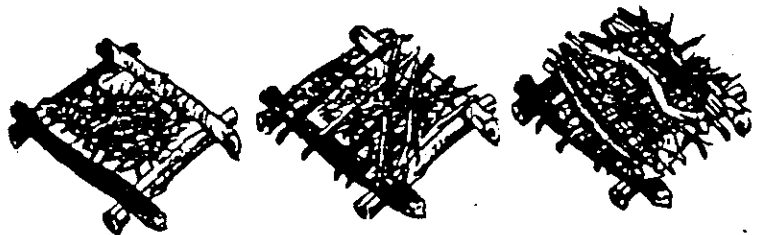

Figure 313 Criss Cross Fire Lay

6. The Crossed Ditch Fire Lay

In the event that a better draft should be needed, you may prepare a crossed ditch in the soil about 3 inches deep and 18 inches long. This

shallow trench will allow a better draft for the fire. The tinder is placed in the center of the crossed ditch with a criss cross fire lay above the tinder. See Figure 314.



CROSS-DITCH FIRE LAY. Prepare the ditch by scratching a cross in the ground, 3 inches deep. This shallow ditch makes it easy for the air to sweep in under the fire lay and thereby provide a good draft for the fire.



Put a large wad of tinder in the middle of the cross ditch, then lay several foundation sticks diagonally over the cross. Build up on those, in crisscross fashion, enough wood for a speedy bed of coals for broiling.

Figure 314 Crossed Ditch Fire Lay

TYPES OF FIREPLACES

Fires should be built with a purpose in mind. A fire may be used for various types of cooking, baking, heating, lighting, drying or for just plain companionship. All of these factors have a bearing on the type of fire that one would build. Different locations may also dictate the type of fire: a desert fire, where wood may not be available, would certainly be different from a fire built in the woods. The direction and intensity of the wind may play a role in how a certain type of fire is built. A good camper knows many different types of fireplaces so that he may feel at ease in any situation.

1. The Sod Fire

Often times a small fire may have to be built on a carpet of grass. If so, one method of building a fire would be to use what is called the "sod fire." In this type, narrow pieces of sod are cut out and laid on either side of the cut out area. The fire is then built in the area where the sod was removed. If a kettle needs heating, it is placed on the sod pieces so that the kettle is suspended across the fire. See Figure 315. When finished, the sod pieces are put back into place, and no trace of the fire is left.

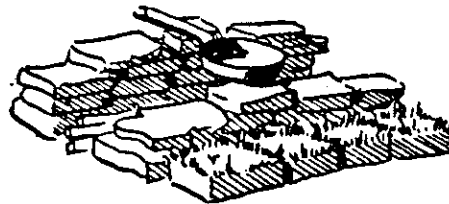

Figure 315 Sod Fire

2. The Three Point or Nomad Fire

A quick and easy fire for making a quick lunch, boiling a pot of coffee, or warming a pan or kettle is a three point or nomad fire. This is made by using three rocks of approximately the same size with a small fire in the center of the rocks. The three points (rocks, tent pegs, etc.) should be close enough together so that



FOR A SINGLE-POT MEAL OR FOR A SINGLE PAN, THREE ROCKS OF EVEN SIZE OR THREE METAL TENT PEGS MAKE A GOOD FIREPLACE.

Figure 316 Three Point Fire

a pan may be set over them. If desired, three metal stakes may be used instead of rocks, as shown in Figure 316.

3. The Stone or Rock Fireplace

The stone or rock fireplace, as shown in Figure 317, is somewhat like the three point fireplace; if you are in an area where rocks are abundant, this may be the fire of choice. Rocks of about the same size, preferably flat rocks, are used. Avoid rocks like sandstone or limestone that may be saturated with water, as heating may cause them to pop or explode.

The rocks should be placed in a "U" formation with the rocks stacked four to six inches high and far enough apart to accommodate the pots and pans that are to be used. The open end of the fireplace should be placed facing the oncoming wind. This is a good fireplace for a quick meal.

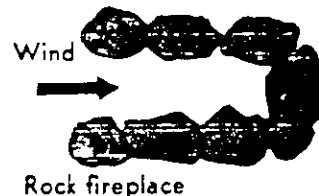

Figure 317 Stone or Rock Fireplace

4. The "U" Wall Fireplace

This fireplace is similar to the rock fireplace except that the walls are wider and higher. The three sides are a stone wall 10 to 18 inches high. Once again, do not use limestone, sandstone or rocks taken from rivers because of their tendency to pop or explode when heated. Pots and pans may be suspended from a green stick which has been put across the top of the stone walls, or some other type of campfire gadget may be improvised. The advantage to the higher walls is more heat reflection, making this fireplace good for drying or warming. This fireplace is shown in Figure 318.

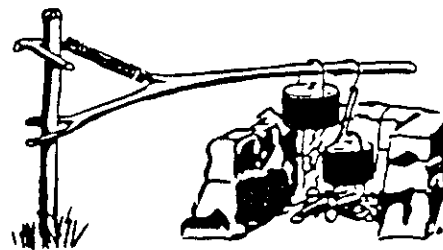

Figure 318 "U" Wall Fireplace

5. The Western Keyhole Fireplace

This fireplace has rocks laid out in the shape of a large key hole. The main fire is built in the larger part of the keyhole, and hot coals can be raked from here to the smaller part of the keyhole to accommodate pots and pans. If a grill is not available, green sticks may suffice. Suitable campfire gadgets may be an added feature. See Figure 319.



Figure 319 Western Keyhole Fireplace

6. The Wigwam, Tepee or Pyramid Fire

This is the same as the tepee fire lay, only larger. This is a favorite type of fire for beginners because it is easily started and gives a large blaze which is fascinating to watch, but it is relatively poor for cooking. This type of fire is usually made 12 inches in diameter and 12 or more inches high. It is a good fire to use for baking biscuits in a reflector oven, but it makes poor coals. It is a good fire for drying or light. See Figure 320.

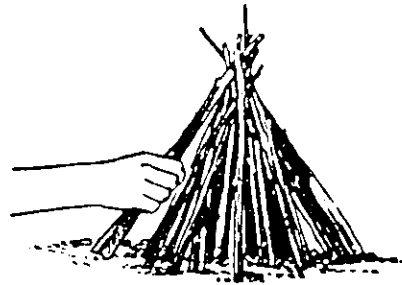
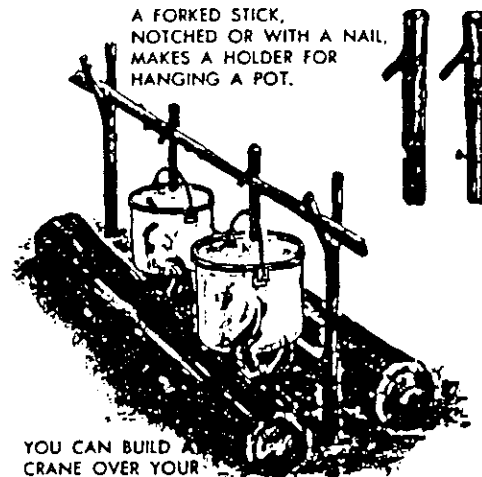

Figure 320 The Wigwam, Tepee or Pyramid Fire

7. The Hunter's or Trapper's Fireplace

This is perhaps the favorite fireplace to build when logs are available. This fire is built using two green logs, about six inches in diameter and two to four feet long. The logs are placed far enough apart to accommodate the pots and pans, and at a slight angle to the wind. A small green "damper" stick can be placed under the log on the windward side so that the log can be elevated slightly to allow a draft into the fire, as shown in Figure 321. This makes a good fireplace because the heat is confined between the logs and is radiated upward. As the logs are burned, they can be rotated or replaced.



YOU CAN BUILD A CRANE OVER YOUR HUNTER'S FIRE FOR HANGING YOUR POTS.

Figure 321 Hunter's or Trapper's Fireplace

A Trapper's fire can easily be converted to a reflector fire by placing one log on top of the other against two stakes that have been driven into the ground. The logs must be rotated so that the glowing surfaces are facing the pan. The pan itself must be elevated far enough up so that the open top faces the logs but not so far that anything falls out of the pan. See Figure 322.

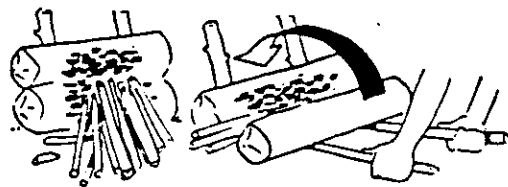

Figure 322 Trapper's Reflector

The Trapper's fire may also be converted to a biscuit oven, which is shown in Figure 323. Two rocks are placed just far enough apart to accommodate the pan and hold the glowing logs over it. When baking biscuits, heat the pan first so that the dough will start to rise and the bottom will be somewhat browned. Then, working quickly, set the pan of biscuits between the rocks and under the glowing logs to complete the baking process.



Figure 323 Trapper Biscuit Oven

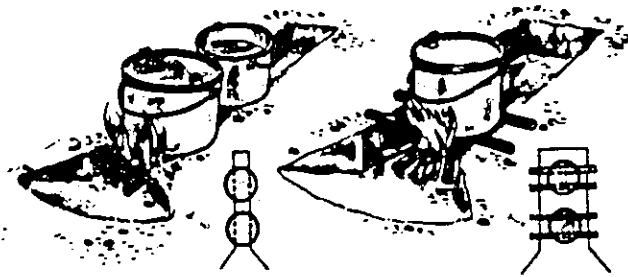

Figure 324 Open Trench Fireplace

8. Open Trench Fireplace

This is the fireplace of choice in an open dry field or if wind or fuel is a problem. On a hot day, a trench fire may be more comfortable because the heat does not radiate as much, the fire is more confined, and less fuel is required. It is also one of the safest fires because it is less likely to get out of hand. See Figure 324.

The trench fire is made by digging a hole wide enough to accommodate the width of the pans you will be using. The trench may be a little wider and shallower at one end to catch a good draft for pans that need more heat, such as frying pans. The trench should be from 2 to 4 feet long and 10 to 12 inches deep at the deepest end with a slope to ground level. The trench should be dug such that the shallow end points into the wind. The fire can be controlled by using something such as a stone or pack as a windbreak on the windward side. If the sod is very sandy, the trench may have to be lined with small stones. The deep end of the trench is best for baking and cooking. Coals can be raked from the deeper end to the shallower end for frying and quick boiling.

9. The Closed Trench Fireplace

A regular open trench fireplace may easily be converted to a closed trench fireplace. This would make a good all around stove for a semi-permanent camp fixture. After a regular open trench fireplace is built, it is good to line the deep part of the trench with fire stones. This will act as an oven. The trench is then covered with a piece of fairly heavy sheet metal. If you could find an ideal thin rock to cover the hole, it would work satisfactorily, but this may be hard to come by. The fire will also be more effective if you can erect some sort of a chimney arrangement at the deep end of the trench. This type of fireplace would give you a good oven, and a good flat-topped stove to use for cooking and frying. This type of stove may also be very effective if built into the side of a small hill, as shown in Figure 325.

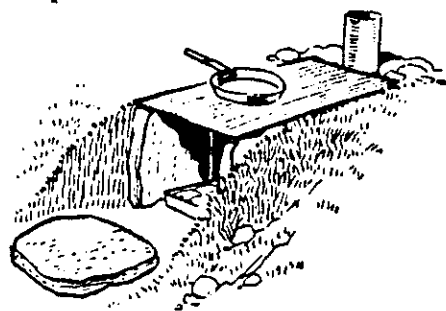

Figure 325 Closed Trench Fireplace

10. The Chinook Fire

The Chinook Fire is a combination of the Hunter/Trapper and Open Trench fireplaces. See Figure 326. This makes a good fireplace for a permanent campsite.

To make the Chinook fireplace, build an open trench fireplace as discussed above. Place two logs, about six inches in diameter, on either side of the trench. If the side logs are too far apart to suspend a kettle between them, a few green cross sticks or iron rods may be laid across the top of the side logs to act as a grill for the pots and pans. See Figure 327. Cooking and stewing may be done on the deep end of the trench and coals can be raked to the shallow end for boiling and frying.

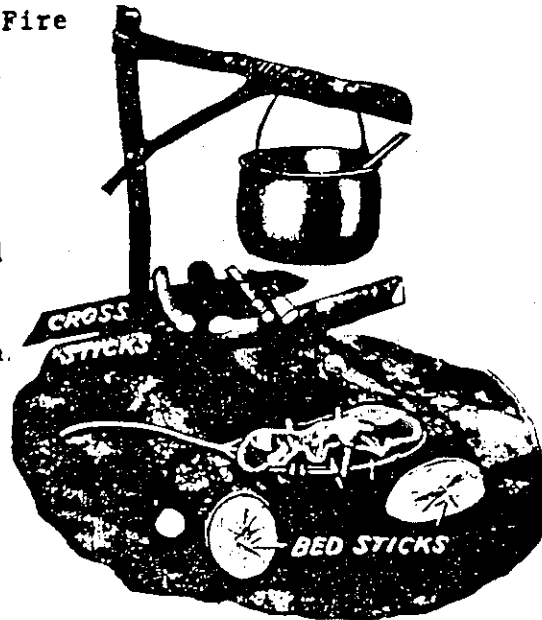

Figure 326 Chinook Fire

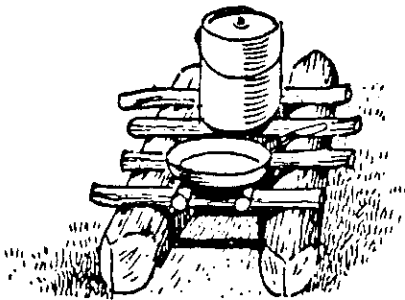

Figure 327 Grill for
Chinook Fire

To turn this fireplace into a hot oven, lay a couple of large cross sticks across the side logs until the under surface becomes glowing embers. Next, close off the deep end of the trench and side logs with rocks, etc; then, with the fire burning, put the covered baking kettle into the oven thus formed, and place the two glowing cross logs with the ember side down across the side logs over the baking area. This type of oven will make a good meal of baked ham and potatoes.

Another method of using this type of oven would be to put a small empty flat tin can inside of the baking kettle. A larger pan filled with food to be baked is set inside of the baking kettle on top of the small empty tin can. The baking kettle is then covered and lowered into the oven. The small empty tin can helps to prevent burning because the only thing in contact with the food pan is hot air.

11. The Backlog Fire

Another take off of the Hunter's fire is the Backlog fire. This requires only one large log about six inches in diameter which is laid at an angle of about 60 degrees to the direction of the wind. A half tepee fire is then built against the log. Laid at right angles to the large log and about 18 inches apart are two smaller green logs about three to four inches in



Figure 328 Backlog Fire

diameter. These logs act as andirons. On top of these two small logs a grill work of green sticks can be laid to support the pots and pans. Once again the larger fire will be next to the larger log and the coals can be raked under the green sticks for frying and baking. If you use a campfire gadget to hold the larger kettle, such as seen in Figure 328, you can easily use both fires at one time.

12. The Tri-Level Fireplace

Another interesting fireplace for a more permanent camp is the tri-level fireplace. A hole about one and a half feet square is dug about five inches deep into the ground. Immediately adjacent to this hole another rectangular hole is dug about 12 inches deep. One end of the first hole spills over into the deeper hole. All of the dirt that is dug up is placed on the outer edge of the deeper hole, making a steep incline or embankment opposite the more shallow hole. Side logs are placed on either side of the shallow hole, and green sticks pass between the cross logs to act as a grill for pans and kettles. Or, if desired, a grill or campfire gadget may be used to hold the cooking kettles. The fire is started in the shallow hole, and hot coals "spill" over into the deeper hole for frying and baking. Baking can also be done by placing a pan against the dirt embankment which receives reflected heat from the hot coals and flames above. See Figure 329.

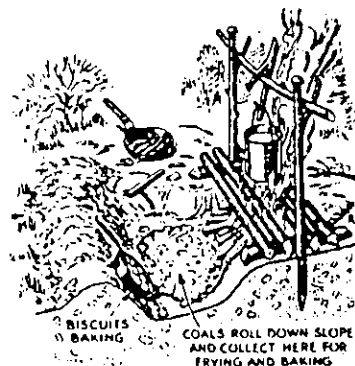
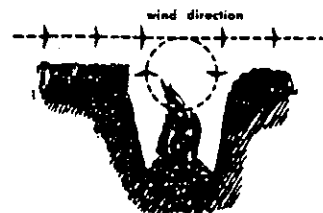

Figure 329 Tri-Level Fireplace

13. Fire-In-The-Hole or Indian Fire

Another type of fireplace which can be used in a windy or treeless area is the Indian or "the-bean-hole" fire. The fire-in-the-hole was used to cook the beans until soft. When the coals in the hole were ready, the bean pot was lowered into the hole for cooking. See Figure 330.

The fire-in-the hole makes a good fire for a quick one pot lunch such as stew, or it can be used for roasting or baking. The hole should be dug about a foot in diameter and from six to twelve inches deep. The dirt should be piled on the ground opposite the side from which the wind is blowing. A criss cross type fire of hard wood built on top of the hole makes a good initial blaze and a good bed of coals will settle down into the hole. Hanging a stew pot in the hole so that the bottom of the pot is just below ground level makes the contents of the pot stew gently below the boiling point for a long period of time.



INDIAN FIREPLACE WAS USED ON THE PRAIRIE TO PRODUCE BED OF COALS. PLACE SODS AND DUG-UP SOIL AS SHOWN.

Figure 330 Fire-In-The-Hole Fire

If desired, the hole can also be covered with a grill of green sticks (see Figure 331) so that you can use the fire-in-the-hole for boiling and cooking, or it may be used without the grill for kabobs or roasting with sticks.

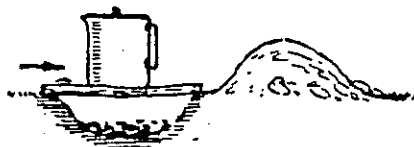

Figure 331 Fire-In-The-Hole Showing Grill Work

Another method of preparing a one pot supper is to put your tinder in the hole and line the edge of the hole with hardwood sticks as shown in Figure 332. The fire may then be lit and the ready pot may be hung in the hole. The burning sticks heat the pot very hot and the coals fall to the bottom of the pit, keeping the pot simmering for a long time.

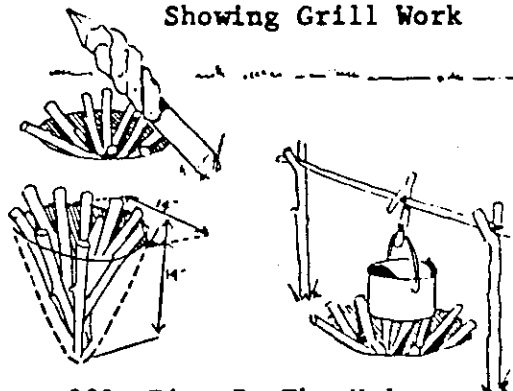
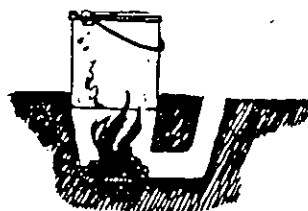

Figure 332 Fire-In-The-Hole Lined With Sticks

14. The Dakota or Buffalo Fireplace

Closely associated with the fire-in-the-hole is the Dakota fire, which is another method of cooking a one pot meal. See Figure 333. This fire originated in the Dakota prairies where high winds made surface fires dangerous and impractical. However, it can be used any place at any time. This particular fireplace is made the same as the fire-in-the-hole, except that in addition to the main hole, a second smaller hole is placed six inches from the main hole and then a passage is tunneled through to the main hole. This passage acts as a chimney and gives more draft to the main hole.



DAKOTA FIREPLACE IS WHITE MAN'S PRAIRIE FIRE FOR COOKING WITH A POT. "CHIMNEY" AT SIDE GIVES NECESSARY DRAFT.

Figure 333 Dakota Fireplace

15. The Star Fire or Lazy Man's Fire

The Star or Lazy Man's fire is fed with long logs. The logs are laid like spokes in a wheel, with the fire at the hub of the spokes. The burning end of the logs should be raised a little with a stick or rock under each pole; these serve as damper sticks and allow the poles to burn more freely. As the fire burns down, the logs are pushed closer into the hub, constantly supplying a new source of fuel. The fire may be started with a tepee fire lay. This makes a good fire if you do not have facilities to cut up the poles. See Figure 334.



Figure 334 Star or Lazy Man's Fire

16. The Vigil Fire

After a fire is already burning, roll on two logs about six inches in diameter and three feet long. Lay one on each side of the fire about three inches apart. Put a couple of draft sticks under each log. Then place a third log on top of the other two. This third log should also be supported by a draft stick on each side. See Figure 335. This fire is a long burning fire.



Figure 335 Vigil Fire

17. The Altar Fire

An Altar fire is an elevated platform, about four feet square and about table height covered with dirt. See Figure 336. With an elevated fire you can cook with the pots and pans at a more comfortable level. Usually there is a better draft when the fire is up off the ground. Making a bench fire of this type is fun if you have a few hours to spare and you are going to make several meals.

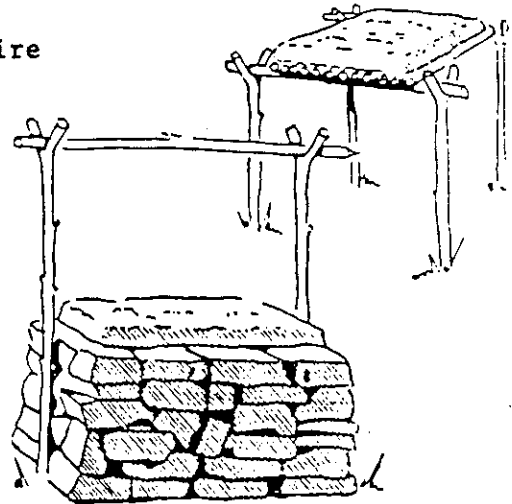

Figure 336 Altar Fire

18. The Reflector Fire

A reflector fire is a fire that is built in front of some type of wall or "fire back" as it is called. This serves to reflect the heat back from the wall. See Figure 337. The reflector fire is sometimes built in front of an open tent or lean-to to reflect the heat back into the shelter.

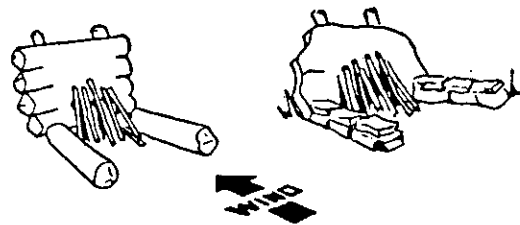

Figure 337 Reflector Fire

A reflector fire is also used for baking in conjunction with a reflector oven. The heat of the flames are reflected from the fire-back into the oven and will bake a pan of biscuits or a cake quite effectively. See Figure 338.

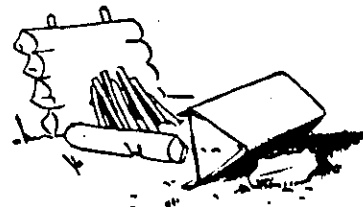

Figure 338 Reflector Fire in Reflector Oven

Sometimes a fire can be built between two ovens, and in this manner each oven reflects heat back to the other oven. See Figure 339.



Figure 339 Radiating Heat Back and Forth Between 2 Reflector Ovens

19. The Criss Cross Fireplace

This type of fire is a take off from the criss cross firelay. A criss cross fire arrangement of hardwood makes an excellent fire especially if you want to end up with a good bed of coals. The initial wood burning blaze may be used for heating or lighting, or it may be used for boiling with the aid of a campfire gadget, and the coals may be used for simmering, roasting or whatever.

In wet weather or on snow covered ground, a fire is apt to burn badly unless the fire is prepared on a good base. One method of eliminating a problem of this type when using a criss cross fireplace is to build the criss cross arrangement on two larger logs, as seen in Figure 340. This will help keep the fire above the wet or snow covered ground.

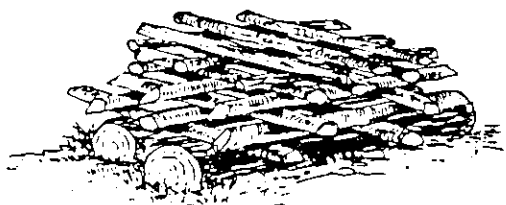

Figure 340 Criss Cross Fireplace

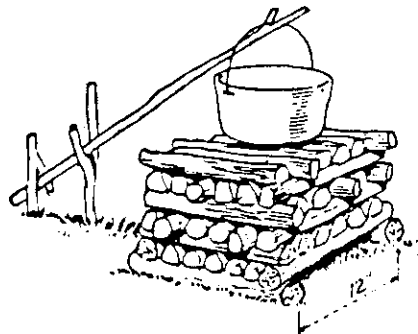

Figure 341 Criss Cross Fire for Dutch Oven Cooking

A cooking fire of this type should be 10 to 18 inches square and about one foot high. It can easily be started by first gathering the necessary fuel poles cut to lengths. Then a small pyramid firelay is started and the criss cross fuel is laid up around the fire. If the wood is damp, start with the smaller fuel pieces at the bottom of the criss cross arrangement. This type of fire is excellent for Dutch oven cooking. See Figure 341.

20. The Log Cabin Fire

This fireplace is often misconstrued with a Council or Friendship fire or the two may be mistakenly interchanged when talking about fireplaces. The log cabin fire is built as if you were building a log cabin. See Figure 342. The logs are laid up toward the center. This

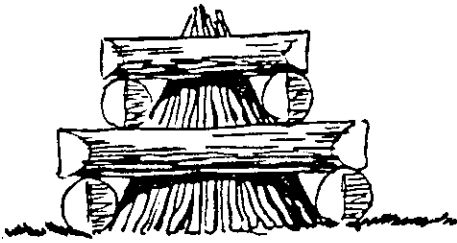

Figure 342 Log Cabin Fire

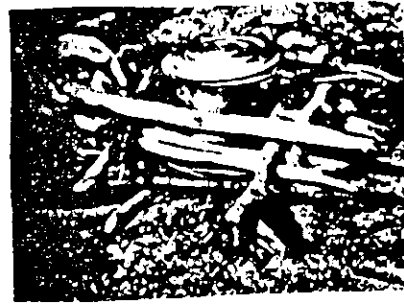

Figure 343 Log Cabin Fire With Kettle

type of fire is used for light rather than heat, however, it will settle down to a good bed of coals. The log cabin fire is lit from the bottom with a tepee fire lay. This style of fire may also be built up around a pot around an existing fire for quick boiling or heating as shown in Figure 343.

This type of fire can be used for a council or friendship fire and there is certainly nothing wrong with this. The main difference between the two fireplaces is that a council fire is lit from the top while a log cabin fire is lit from the bottom. Furthermore, the council fire is laid up in a criss cross manner while the log cabin fire is laid up with two logs in each direction tapering at the top. It is just an interesting note in order to differentiate the two fires.

21. The Council or Friendship Fire

A Council fire is a larger criss cross fire that tapers in at the top. It is somewhat like a log cabin fire, but instead of building it log cabin style, there are several logs on each layer as shown in Figure 344.

A Council fire is usually a large fire used for campfire programs. It is lit from the top with a small crisscross fire lay. By lighting a large fire from the top it burns downward instead of upward and as a result the fire will last longer. When the campfire is first lit, the group usually likes a lot of flame, crackling and embers floating into the air. Then as the program wears down and the fire burns low to a rich glow, the group settles down and it becomes time for a closing ceremony.



Figure 344 Council Fire

22. Imu

Imuing is a method of cooking in a hole in the ground. To begin, dig a hole about 18 inches in diameter and 18 inches deep. Line the hole with baseball size rocks or flat rock as shown in Figure 345-A. But remember to avoid the water logged sandstone and limestone type of rocks. Build a hot fire in the hole and keep adding fuel to the fire so it will burn at least an hour or two. Perhaps a large criss cross fire on top of the hole will do the trick. When the pit is ready, the hole should be nearly filled with hot coals. The stones in the hole should be red hot. Working quickly, remove the hot embers with a shovel, line the hot rocks with a couple of gallons of sweet leaves such as basswood, wild grape vine, maple, tops of beets, lettuce, celery, etc. Lay the meat and vegetables in the hole and cover the food with another peck of leaves. Then cover the hole with an old burlap bag or piece of canvas and cover it completely with earth. Let the food bake for at least two to three hours. This type of meal is especially good with fowl or fish. See Figure 345-B.



A.

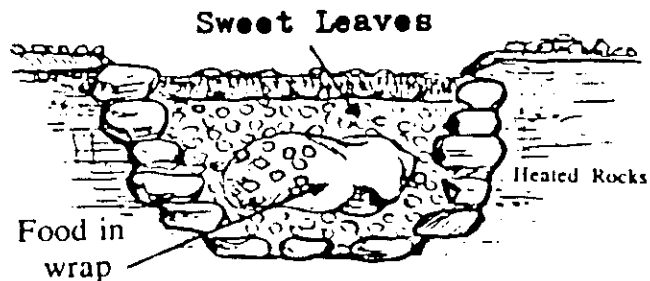

A Simple Method of Baking Food.

B.

Figure 345 Imu Pit

23. The Steam Pit

A steam pit is the same thing as an Imu, except that the sweet leaves used to envelop the food should be soaked in water before putting them into the pit. See Figure 346. Earth should be piled thick enough on top of hole so as not to allow steam from the pit to escape.

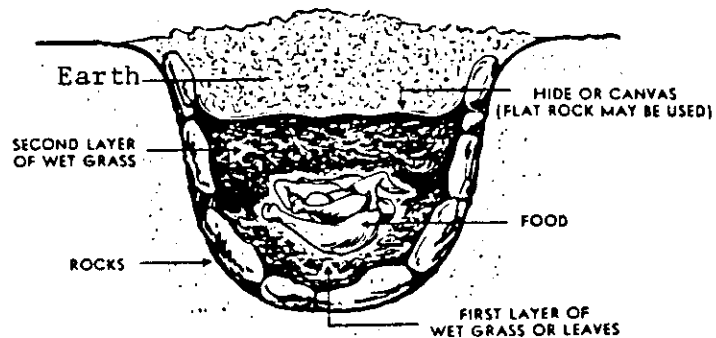

Figure 346 Steam Pit

24. Above-The-Ground Pit

An Above-the-Ground Pit may be prepared by making a large bowl shaped rock formation. Build a fire inside the rock bowl and keep it burning until the bowl is filled with hot glowing embers. This should take about an hour.

Again working quickly, remove the hot embers from

the rock bowl, place the food (which has been enclosed in aluminum foil) into the rock bowl, put the embers from the bowl on top of the food parcel and cover it with dirt. Allow a couple of hours for the food to cook, depending upon the amount and type of food. See Figure 347. If desired, sweet leaves may be used wet or dry instead of or in addition to the aluminum foil.



Figure 347 Above-the-Ground Pit

25. Miscellaneous Fires

Like most other things, fires and fireplaces can be slightly modified and given a new name. As a result, the list of the different types of fireplaces can keep going, but those listed above are the major types of fires and fireplaces.

Figure 348 shows three fires that take their name from the fireplace gadget: The Crane fire, using a crane; the Gypsy fire, using a tripod; and the Bridge fire, using a lug pole with uprights and pothooks.

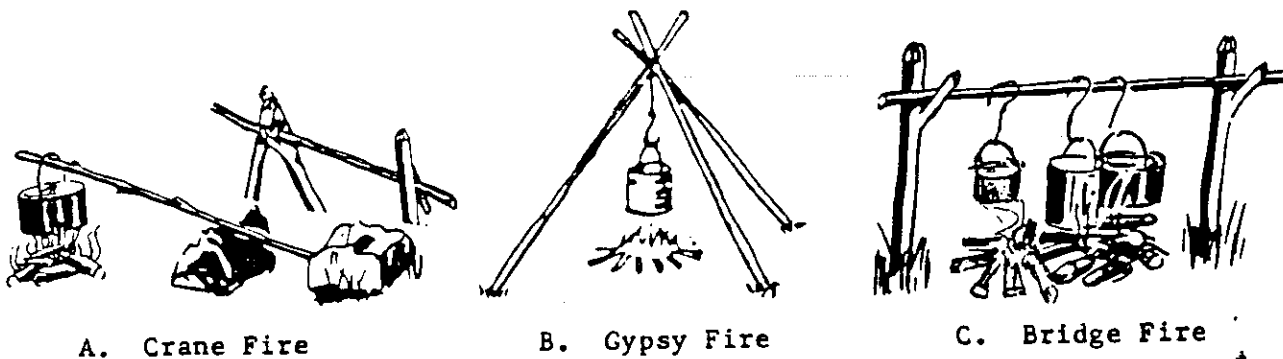

Figure 348 Miscellaneous Fires

CHAPTER 12

ESTIMATIONS

Estimating is not merely guessing. Instead it is calculating approximately or forming a judgment by some workable means. Estimating is needed for pioneering, making a rough sketch map and for many other things in bushcraft and camping. The ability to estimate heights, distances, widths, directions, time, etc. can be very useful.

Thus far in the book we have covered estimating the speed of a current on page 188, the buoyancy of a log raft on page 184, checking the time of day with a compass on page 171, and pacing on page 166.

Perhaps the most important of these is knowing your pace or the length of your step. The best way to do this is to set up a 100 foot walk way on level ground and then pace the distance with your natural step once in each direction, each time counting the number of paces. Average the number of paces for the 100 feet, then calculate the length of your pace by dividing the 100 feet by the average number of paces. This will be the length of your pace or step! A stride is two steps. You should also know how your pace alters going uphill and downhill.

Besides your pace there are other personal measurements that you should be familiar with as shown in Figure 349. These include your personal height, height to tip of extended hand while standing flatfooted, the distance of your extended arms from finger tip to finger tip, the span of your outstretched hand from the end of your thumb to the end of your little finger, the length of your bare foot and length of your boot.

Together with knowing your personal measurements and then being able to visualize that a dollar bill is 6 inches long, a yardstick is 3 feet long, the distance between the bases of a baseball diamond is 90 feet and a football field is 100 yards long, you will have a good beginning supply of known measurements which can help you in estimating distances.

Like anything else, this takes practice. When practicing the estimation of distances a few interesting things will become apparent.

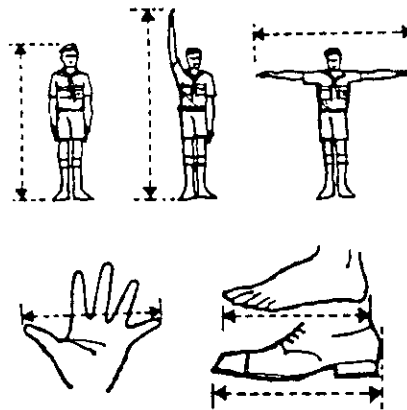

Figure 349 Personal Measurements Chart

Distances are usually overestimated under the following circumstances:

1. When the sun is shining from behind the object.
2. When lying or kneeling.
3. When backgrounds and objects are of similar color.
4. When looking over a valley or open country.
5. Along long streets, avenues and ravines.
6. When the object is in the shade.
7. If the object is only partly seen.
8. In the mist of failing light.

Distances are usually underestimated under the following circumstances:

1. When the sun is shining behind the observer.
2. On a bright sunny day.
3. After a heavy rain.
4. When the background and object are of different colors.
5. When the ground is level.
6. When looking over water.
7. When looking up or down.
8. When the object is large compared with its surroundings.

ESTIMATING DISTANCE BY SOUND

Sound travels 1100 feet per second. By counting the seconds from the time you see an action to the time you hear it, you can estimate the distance by multiplying the number of seconds elapsed by 1100 feet. This is used chiefly for lightning but it may also be used for things such as pounding, chopping or even an echo. If it is used for an echo, remember to divide the time by two because the echo has had to go and come back. See Figure 350.

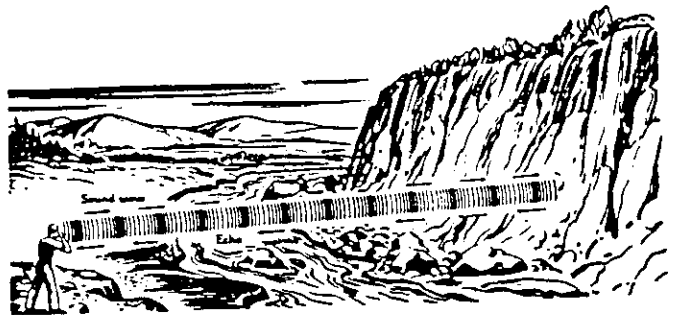

Figure 350 Determining Distance by Echo

ESTIMATING NUMBERS

Sometime you may wish to estimate numbers - such as the numbers of people in a block at a football stadium. Probably the best way to do this is to divide the block into smaller equal areas. Then count the number of people in one or two of these areas and use this as an average for the rest of the areas. Lets say you divided a full block of people into 20 equal areas. You counted an average of 100 people in two of the twenty areas. Twenty areas, times the 100 people averaged in each area, would amount to 2000 people in the block.

ESTIMATING SUNSET

Once in a while you may want to know how long it is going to be before dark. Hold your hands at arms length and see how many fingers you can fit between the sun and the horizon. Allow about 10 minutes before dark for each finger. This works especially well if the horizon is flat such as on a sea or lake. See Figure 351.

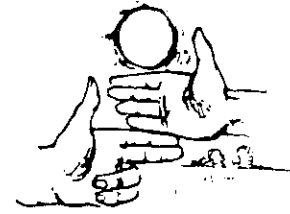

Figure 351 Estimating Time at Sunset

ESTIMATING HEIGHTS

There are a number of methods of estimating heights, and it is good practice to measure each height by at least two methods. Note that the slope of the ground may affect your results, so that it is better to check your answer from two positions and take the average. Here are four methods to try:

1. Lumberman's Method

Stand well away from the object and hold a twig at arm's length from your body. Arrange the twig so that the tip is in line with the top of the tree being measured, and move your thumb up or down until it is in line with the base. Now swing the twig through a right angle, keeping your arm steady, so that your thumb remains level with the base of the object. Observe the point on the ground at right angles to the tree where the tip of the twig now appears to rest. The approximate height of the object can be measured by pacing the distance from the base of the object to this point. See Figure 352.

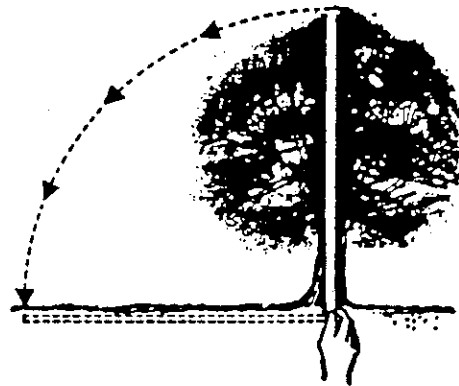

Figure 352 Lumberman's Method of Determining Heights

2. Artist's Method

At the base of the object place an article (such as a staff or a person) of known height. Stand well away from the object, then holding a pencil or twig at arm's length, arrange for the tip of the pencil to be in line with the top of the staff or person and the thumb to mark the ground level. Next estimate how many times this

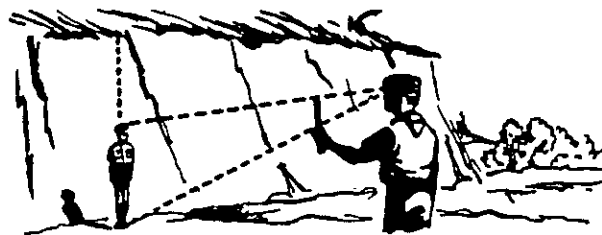

Figure 353 Artist's Method of Determining Heights

distance will go into the height of the object and multiply by the height of the article. See Figure 353.

3. One In Twelve Method

This is a very accurate method. From the base of the object a distance of eleven units is marked off. The unit may be of any convenient length - the length of a staff, or even two or three staff lengths - but best results are obtained when the twelve units distance approximates the height of the object. At the eleventh unit mark the spot, then take a further unit, making twelve in all. The staff is then held vertically (most important) at the eleventh mark. From a fixed eye position near the ground, sight both top and bottom of object.

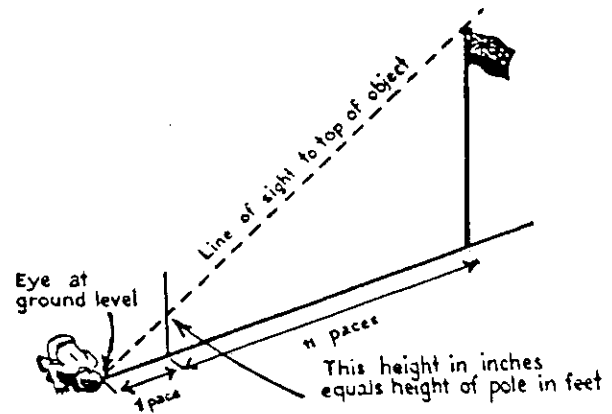

Figure 354 One In Twelve Method of Determining Height

Mark points where line of sight cuts the staff. Distance between these marks in inches represents height of object in feet. See Figure 354.

4. Shadow Method

In order to use the shadow method the tree or pole that you want to estimate the height of must produce a measurable shadow on the ground. Place a staff or pole of known height into the ground out under the sun and measure the length of the staff's shadow. Then measure the length of the tree or pole shadow. The next step is to divide the length of the tree shadow by the length of the staff shadow. By multiplying the height of the staff with the figure found you will have the height of the tree. For example:

A tree casts a shadow 20 feet long.
 A 10 foot pole casts a shadow 5 feet long.
 $20 \div 5 = 4$ times 10 = 40 feet
 or a simple algebraic formula
 $\frac{10}{5} = \frac{X}{20} = 20 \div 5 = 40$ feet

ESTIMATING WIDTHS USING THE NAPOLEAN OR CAP-VISOR METHOD

There are several ways of estimating distance across a river. We will bring into use two methods in this chapter, but both methods need practice for accurate results. The stick method brings into play the use of simple geometric triangles, whereas the Napolean method brings into play the hand over the forehead, the visor of a cap or the brim of a hat.

In the Napoleon Method, Figure 355, the estimator stands on one shore of the river and places a flat hand against the eyebrows, with palm down. Slant the hand until the outer edge seems to touch the opposite shore. Without moving the head or arm, turn the body 90° transferring the distance across the river to your side of the river. The distance to the point on your side of the river, which the edge of your hand now seems to touch, is the width of the river. This distance is then paced off to get the final estimate.

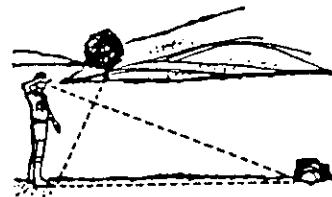

Figure 355 Napoleon or Cap-Visor Method of Determining Width

This maneuver may also be done with a visor cap or a brimmed hat such as Napoleon might have worn. The head should be bowed with the chin against the chest so that the outer edge of the brim or visor seems to touch the opposite shore. Then, without moving the head, turn the body a full right or left turn "transferring" the distance to your shore. The distance from where you are standing to the point where the visor of your cap seems to touch is the width of the river. Pace it off.

ESTIMATING WIDTH USING THE STICK METHOD

This requires a lot of open space on your side of the river. Select a landmark such as a tree on the water's edge on the opposite bank of the river at a spot where the river's course is fairly straight. We call this point "X". Now place a stone or a peg at a point "Y" exactly opposite it. Pace out 20 paces at right angles to the line X Y and put a peg or a stone at this point "A". Pace out a further 20 paces in the same line. Put a peg or a stone at this point "B". Turn and walk at right angles to the line Y B and stop when the points "X" and "A" are in line. This is point "C". The width of the river is equal to the distance B C. This method is shown in Figure 356.

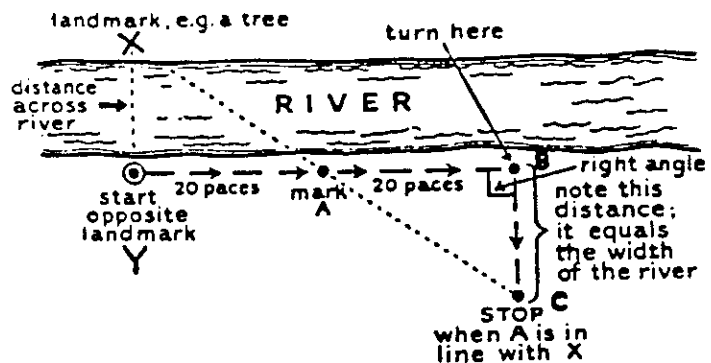

Figure 356 Stick Method of Determining Width

DIRECTIONS FROM THE SUN

You can determine directions from the sun's position at any time of the day as well as in early morning and early evening.

The Zenith is the point in the sky directly overhead. In the north temperate zone, the path of the sun is distinctly south of the zenith in winter, and almost overhead during summer. At noon, in winter, the sun

will be due south of you. In the South Temperate Zone, the situation is reversed. In the Tropics, the noon sun will be roughly either east or west of you or directly overhead depending on the date and season. See Figure 357.

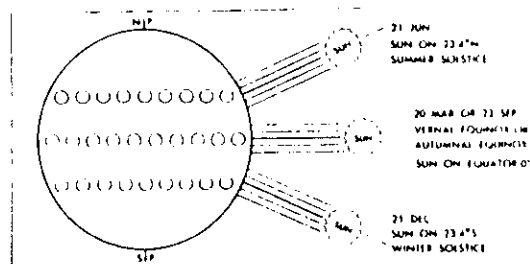

Figure 357 Position of the Sun at Equinox and Solstice

On the next few pages we will cover six different methods of using the sun as an aid to finding directions. These will consist of the Sun and Watch Method, the Shadowless Stick method, the Shadow Tip Method, the Shortest Shadow Method, the Staff and Circle Method and the Plumb Bob Method.

1. The Sun and Watch Method

In the northern hemisphere, a watch set by local sun time can be used to determine a rough direction. Point the hour hand toward the sun. South will be halfway between the hour hand and 12:00. See Figure 358-A. An easy way to do this is to hold up a thin object such as a match stick, a sliver of wood or a piece of straw, so that it casts a shadow. Run the shadow from the side of the watch down the hour hand. This forms the first side of an angle. Then draw an imaginary line from the center of the watch to noon. This is the second side of the angle. Now bisect this angle. Half way between the hour hand and 12:00 is south. See Figure 358-B.

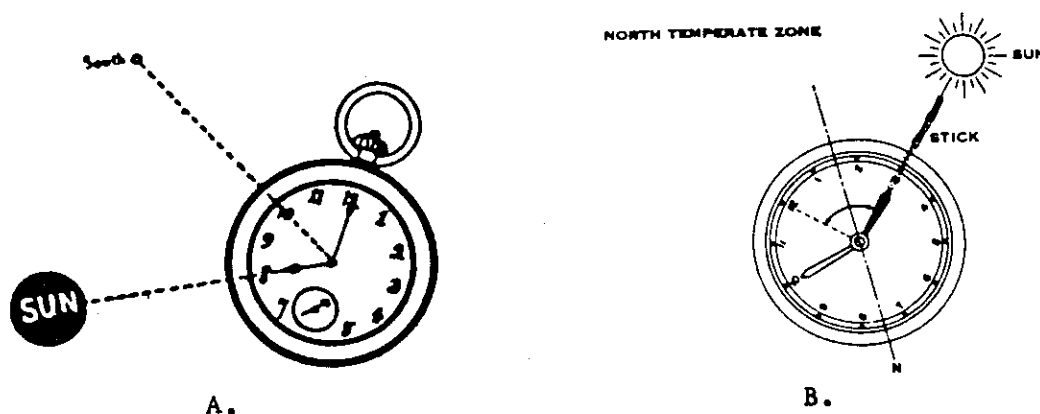

Figure 358 Sun and Watch Method of Finding North in the North Temperate Zone

Of course, you must remember that this is only between the hours of 6 a.m. and 6 p.m. standard time. Between the hours of 6 p.m. and 6 a.m. standard time you have to divide the large angle to find south. If the time is exactly noon, both hands point south.

This method works fairly well near the North Pole in summer and it is fairly effective in Alaska, northern Canada and similar latitudes, but it is not too accurate in the North Temperate Zone. Here, in the morning, the error is east of south and in the afternoon the error is west of south.

If you are using a digital watch, place an upright stick in the ground so it will cast a shadow. Then draw a picture of a traditional watch face on the ground with the hands oriented to show the correct time. Make the drawing of the clock so that the shadow from the stick falls along the hour hand toward the center of the watch drawing.

If you are on daylight savings time remember to set the watch back an hour.

The watch may also be used to determine direction in the South Temperate Zone. However, it is used a bit differently. Twelve o'clock is pointed toward the sun, and halfway between 12:00 and the hour hand will be north. See Figure 359.

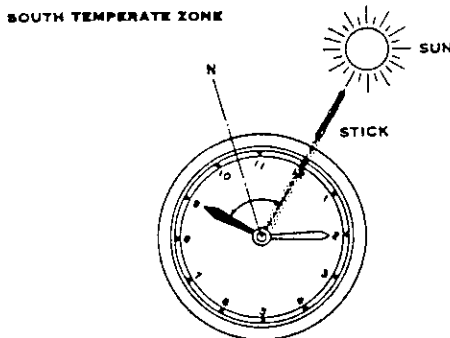

Figure 359 Sun and Watch Method of Finding North in the South Temperate Zone

There is some degree of error in all sun, star and moon sighting methods, but they are good to know if you are without a compass and you want to make a good estimate.

2. The Shadowless Stick Method

This is perhaps the easiest and quickest way of finding an estimated west-east line. For this method, hammer into the ground a straight stick, two feet long or longer, at such a slant that the top of the stick points toward the sun. When this is done correctly, the stick will cast no shadow. Then wait until a shadow has formed long enough for easy reading - at least 6 to 8 inches or more long.

This shadow points east from the stick. It lies in a line that is closely true west-east, with west toward the base of the stick and east toward the tip of the shadow. See Figure 360. However, the line will be a little south of west in the morning and a little north of west in the afternoon.



Figure 360 Shadowless Stick Method

At the equinoxes (the time of the year when day and night are of equal length) the shadow formed at any time of the day will be an exact true west-east line. That is the case at

both the spring and autumnal equinox. At other times of the year, the shadow will be very close to west-east in the middle of the day, but less correct in early morning and late afternoon. The variations as shown in the diagram in Figure 361 will be greatest the closer you are to the longest day of the year (usually June 21 or 22) and the shortest (December 22). In spite of these variations, the directions found are still usable year-round for all general hiking and survival purposes.

By studying the diagram, you can determine the number of degrees by which the directions of the shadows differ from an exact east-pointing direction. By adding this number to or subtracting it from the 90° that stands for east, you will get the shadow's correct direction.

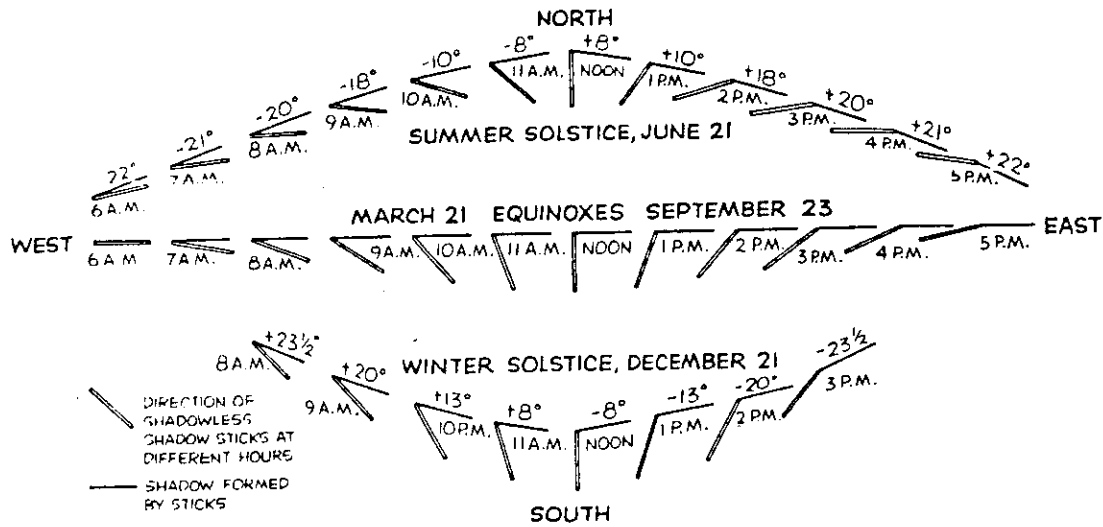

Figure 361 Diagram Showing How Shadows Cast by the Shadowless Stick Method Fall at Different Times of the Day and at Different Times of the Year

3. The Shadow Tip Method

Place a vertical 3 to 6 foot staff or rod into the level ground so that the rod is as vertical as possible. Use a plumb bob if available. Mark the end of the shadow with a peg, stone or other means.

Wait until the shadow tip moves a few inches. If you are using a 4 foot stick, about 10 to 15 minutes should be sufficient. Mark the new position of the shadow tip in the same way as the first.

Now draw a straight line through the two marks to obtain an approximate

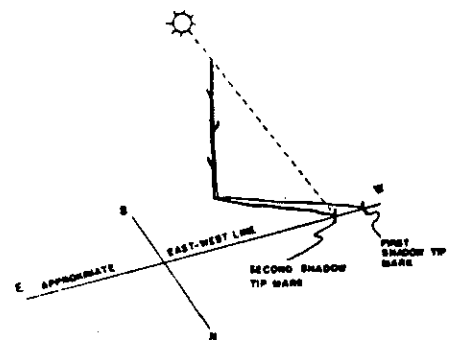

Figure 362 The Shadow Tip Method

east-west line, with west in the direction of the first shadow mark and east in the direction of the second mark. See Figure 362. A line drawn at right angles to the east-west line at any point is the approximate north-south line.

A variation of the Shadow Tip Method is shown in Figure 363.

1. Push a straight stick about 3 feet long into the flat ground so that the stick is straight up and down. Notice that the stick casts a shadow.
2. Mark the tip of the shadow with a small rock and wait until the shadow moves 6 to 8 inches.
3. Mark the tip of the second shadow.
4. Draw a line from the first rock to the second rock and about a foot past the second rock.
5. Stand with the toe of your left foot at the first rock and the toe of your right foot at the end of the line you drew.
6. You are now facing north!

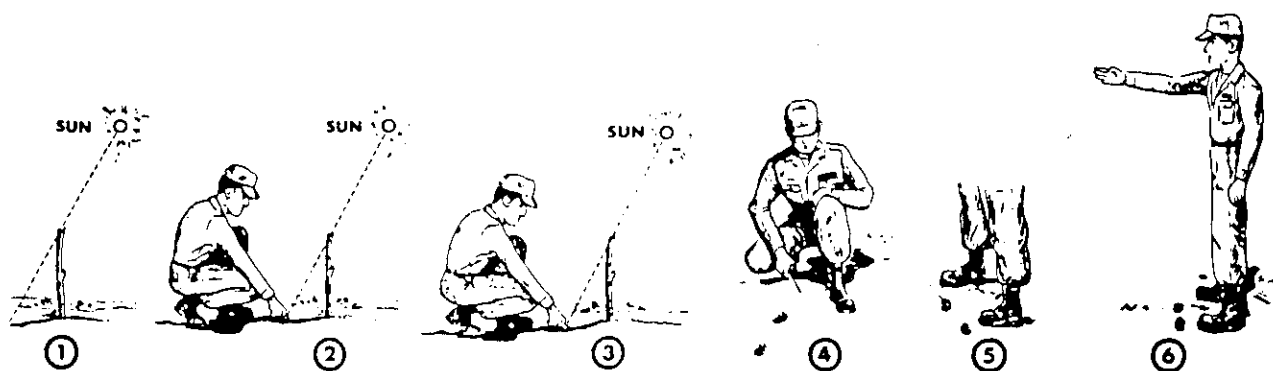

Figure 363 A Variation of the Shadow Tip Method

The sun rises in the east and sets in the west (but rarely due east and due west). The shadow tip moves just the opposite. Therefore, the first shadow tip mark is always in the west direction and the second mark in the east direction, EVERYWHERE on earth.

As in the Shadowless Stick Method, this method is also one that is not as accurate as the remaining three methods.

Determining Time by the Shadow Tip Method Via the Shadow Clock Method

The Shadow Tip Method for finding directions may also be used to find the approximate time of day by using the Shadow Clock Method as follows:

1. Move the upright stick from the Shadow Tip Method to the intersection of the east-west line and the north-south line, and set it vertically in the ground. Extend the lines on the ground. The west part of the line indicates 0600 hours, and the east

- part of the line is 1800.
2. The north-south line now becomes the noon line. The shadow of the stick is an hour hand in the shadow clock and with it you can estimate the time using the noon line and the 6 o'clock line as your guides. See Figure 364. Depending on your location and the season, the shadow may move either clockwise or counterclockwise, but this will not alter your manner of reading the shadow clock.

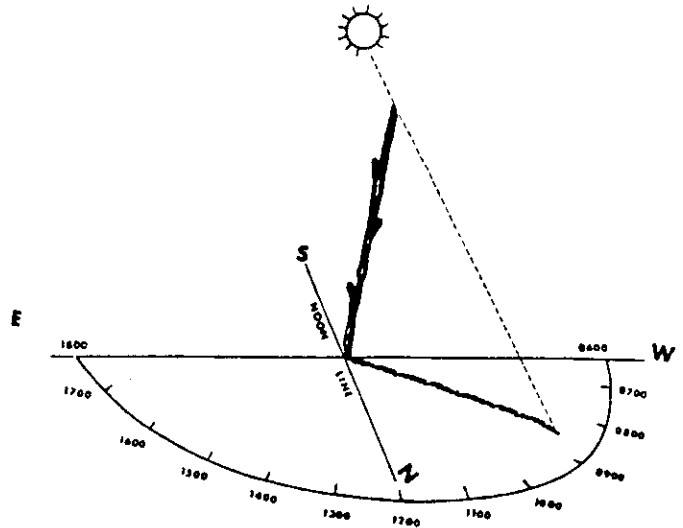

Figure 364 Determining Time by the Shadow Tip Method

3. The shadow clock is not a timepiece in the ordinary sense. It makes every day 12 unequal "hours" long and always reads 0600 at sunrise and 1800 at sunset. However, it does provide a satisfactory means of telling time in the absence of clocks and watches. Twelve o'clock shadow clock time is always true midday, but the spacing of the other hours, compared to conventional time, varies somewhat with the locality and date.

4. The Shortest Shadow Method

This is a variation of the Staff and Circle Method of finding a north-south line. The way of utilizing the Shortest Shadow Method is to, sometime before noon, drive a 6 foot straight stick in an upright position to act as a shadow stick. Where the tip of the stick's shadow hits the ground, hammer in a small peg as a marker.

After 20 to 30 minutes, hammer another peg into the ground at the point where the tip of the stick's shadow now hits it. Continue hammering in other pegs as markers at several more 20 to 30 minute intervals until you realize that the length of the shadow, after having grown shorter, is again getting longer. Now, using a straight stick, measure the distance from the base of the shadow stick to each of the markers, to determine at which point the shadow is the shortest. Here, lay the measuring stick on the ground with one end touching the shadow stick. Your measuring stick has now become a direction stick, with south in the direction toward the shadow stick and north in the opposite direction.

Whenever you use the sun for determining a direction, keep in mind that the sun, during the day, travels from east in the morning through south at noon to west in the afternoon, and that the shadow it casts goes in the opposite direction - from west to east.

An alternate method of using the Shortest Shadow Method is as follows: put up a stick or rod as nearly vertical as possible, in a level place. Check the alignment of the stick by sighting along the line of a makeshift plumb bob. (To make a plumb bob, tie any heavy object to a string and let it hang free. The line of the string indicates the vertical). Sometime before midday begin marking the position of the end of the stick's shadow as in Figure 365. Note the time for each mark. Continue marking until the shadow definitely lengthens. The time of the shortest shadow is the time when the sun passed the local meridian or local apparent noon. You will

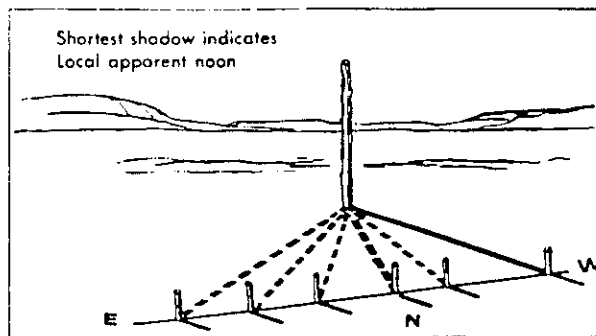

Figure 365 The Shortest Shadow Method Used in the North Temperate Zone

probably have to estimate the position of the shortest shadow by finding a line midway between two shadows of equal length, one before noon and the other after. The shortest shadow points north and the base of the upright stick is south in the North Temperate Zone. It points the opposite direction in the South Temperate Zone.

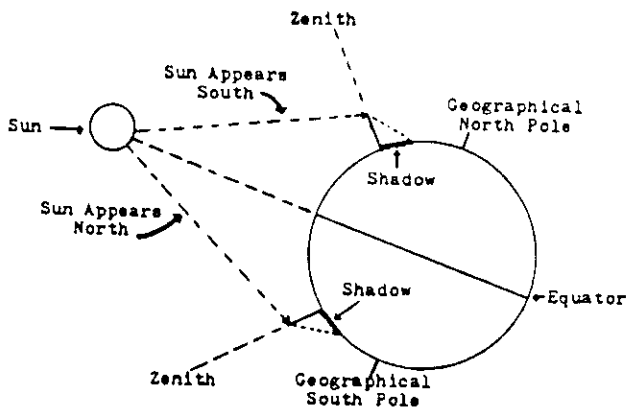

Figure 366 The Sun in Relation to the North and South Hemispheres

The reason for this is because north of the Tropic of Cancer the sun never reaches directly overhead. Instead, it always is in the southern sky. This causes the shadow to fall north of the stick. Thus, the base of the stick is in a southerly direction. It is just the opposite for the southern hemisphere. The sun always appears in the north, casting a southern shadow and therefore the base of the stick points north. Figure 366 tries to illustrate this fact.

In the Tropics this works a little differently. The Tropic or Torrid Zone is between the North and South Temperate Zones. In the Tropic Zone the sun can be north or south of you or directly overhead, depending upon the time of the year and your latitude.

The sun's rays never come from directly overhead in any region outside of the Tropic Zone. The rays are slanted at different degrees toward the earth's surface at noon in all parts of the world north of the Tropic of Cancer and south of the Tropic of Capricorn.

The Tropic of Cancer marks the northern boundary of the Tropical Zone. It lies 23°27' north of the Equator.

The Tropic of Capricorn marks the southern boundary of the Tropic Zone. It lies $23^{\circ}27'$ south of the Equator. To make the latitude $23^{\circ}27'$ more easily worked with it is usually rounded off at $23\frac{1}{2}^{\circ}$.

5. The Staff and Circle Method

This method of finding a north-south line is also called the Equal Shadow Method. This variation of the Shadow Tip Method is more accurate and may be used at all latitudes less than 66° at all times of the year.

Place a stick or branch into the ground vertically at a fairly level spot where a distinct shadow at least 12 inches long will be cast. Mark the shadow tip with a stone, twig, peg or other means. This must be done 5 to 10 minutes before noon (sun time).

Then trace an arc using the shadow as the radius and the base of the upright stick as the center as shown in Figure 367. A piece of string, a long shoelace or a second stick may be used to do this.

As noon approaches the shadow becomes shorter. After noon, the shadow lengthens until it crosses the arc. Mark the spot as soon as the shadow tip touches the arc a second time.

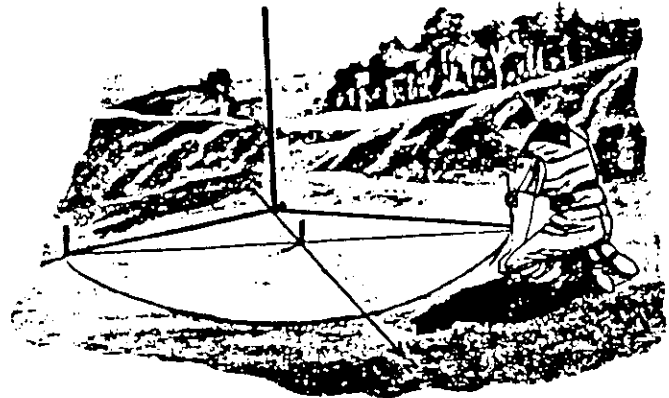

Figure 367 The Staff and Circle Method

Draw a straight line through the two marks to obtain an east-west line - west being in the direction of the morning marker. A line drawn perpendicularly on this line at any point on the line will be a north-south line with south being toward the upright stick.

6. The Plumb Bob Method

This method is chiefly used to find direction in the North Arctic Region. A relatively accurate determination of true north can be obtained by suspending an improvised plumb bob from an inclined stick. This method can be used anywhere on earth but it is especially useful in the true North Arctic, because other methods tend to be unreliable and the North Star is too high in the sky.

The makeshift plumb bob, consisting of a stone or other small heavy object, is suspended by a string from the end of an inclined stick as

seen in Point D in Figure 368. Sometime in the morning, mark the stick's shadow tip as in Point B. Using the Point A on the ground directly underneath the plumb bob as center, draw a semicircle passing through this shadow tip

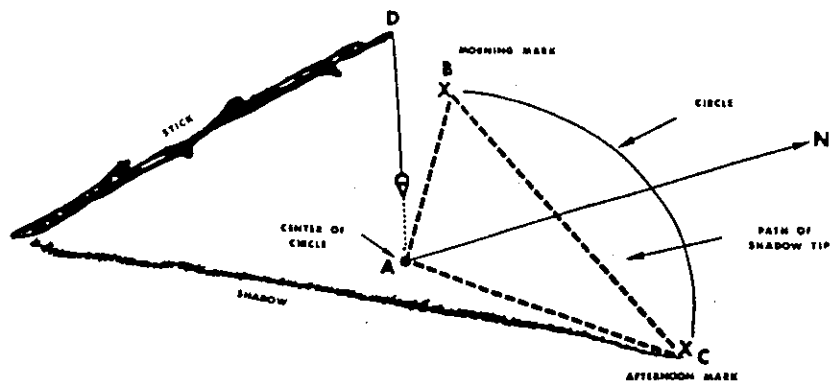

Figure 368 The Plumb Bob Method

mark. In the afternoon, the stick's shadow tip will cross the semicircle at Point C. Draw a straight line connecting B and C. The line bisecting line BC and drawn from A, points true north.

SUMMARY OF ORIENTATION USING THE SUN AND SHADOW

The Shadowless Stick Method and the Shadow Tip Method both find an east-west line. These two methods can be used almost anywhere on earth between the Arctic Circles. These two methods are not as accurate as the later methods, but for most purposes, they will give you a good estimate.

The Shortest Shadow and the Staff and Circle Methods find a north-south line and are more accurate than the former two methods.

To help understand these latter two methods you should know the rules for finding a north-south line anywhere in the world so we will try to summarize as follows:

The Ecliptic is the apparent path of the sun among the stars or of the earth as seen from the sun. This is due to the revolution of the earth around the sun.

The Equinox is either of the two times each year when the sun crosses the equator and day and night are everywhere of equal length; the Vernal Equinox being about March 21 and the Autumnal Equinox being September 22 or 23. It is either of the two points on the celestial sphere where the celestial equator intersects the ecliptic.

The Solstice is one of two points on the ecliptic at which its distance from the celestial equator is greatest and which is reached by the sun each year about June 21st to begin summer in the northern hemisphere and on December 21st to begin winter in the northern hemisphere. This is the opposite in the southern hemisphere.

For any given day, the sun appears to move across the sky (due to the rotation of the earth) at a specific latitude. Throughout the seasons, the sun moves from the northernmost latitude ($23\frac{1}{2}^{\circ}$ on the summer solstice) an average of $.25^{\circ}$ each day until on the Autumnal Equinox, when the sun is directly over the Equator. It continues moving south an average of $.25^{\circ}$ each day until at its southernmost point (winter solstice $23\frac{1}{2}^{\circ}$), it begins again moving north at an average of $.25^{\circ}$ each day until it passes through the Vernal Equinox, when the sun is again directly over the Equator. It continues its northern path until it again reaches the summer solstice. It takes one complete year for the sun to move on this route. Each day of the year, the sun is directly overhead at a given latitude between $23\frac{1}{2}^{\circ}$ N and $23\frac{1}{2}^{\circ}$ S. This annual path that the sun appears to take is marked by the ecliptic. Figure 369 helps explain this phenomenon.

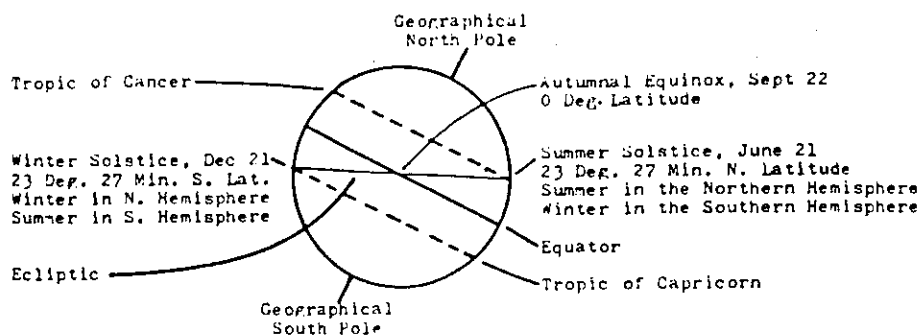

Figure 369 The Ecliptic and Shadow Phenomenon in the Torrid Zone

Between $23\frac{1}{2}^{\circ}$ N and $23\frac{1}{2}^{\circ}$ S, you must determine if your latitude is north or south of the ecliptic. If, at noon local apparent time, the sun is south of your zenith (a point directly over your head), you are then north of the ecliptic and you use the rules for the northern hemisphere. If, at noon, the sun appears north of your zenith, you are south of the ecliptic, and the rules of the southern hemisphere are used. (You can approximate north by using one of the faster, less accurate, methods).

NORTHERN RULE - In the North Temperate Zone, the base of the stick on the Staff and Circle and the Shortest Shadow Methods points south.

SOUTHERN RULE - In the South Temperate Zone, the base of the stick on the Staff and Circle and the Shortest Shadow Methods points north.

1. North of Latitude $23\frac{1}{2}^{\circ}$ N - always use the Northern Rule.
2. South of Latitude $23\frac{1}{2}^{\circ}$ S - always use the Southern Rule.
3. Between $23\frac{1}{2}^{\circ}$ N and $23\frac{1}{2}^{\circ}$ S, determine if the sun is north or south of your zenith at noon. If it is south, use the Northern Rule. If it is north, use the Southern Rule.
4. If you are north of the ecliptic, use the Northern Rule. If you are south of the ecliptic, you use the Southern Rule.
5. If you are on the ecliptic, the sun will appear directly overhead at noon and you must identify east and west ends of your line by the rising and setting of the sun.

DIRECTIONS FROM POLARIS

In the northern hemisphere one star, Polaris, (The North Star or Pole Star) is a little more than 1 degree away from true north. Figure 370 shows several methods that will help one locate Polaris. Perhaps the easiest method is to find the Big Dipper (Ursa Major). The two stars on the outer edge of the Big Dipper are called the "Pointer Stars." They point almost directly toward the North Star. Polaris is about 5 times the distance between these Pointer Stars measured from the "lip" of the dipper on a straight line connecting the pointers and extended toward Cassiopeia. See Figure 371. Polaris, or the North Star, is the end star in the handle of the Little Dipper (Ursa Minor). It must be remembered that because of the rotation of the earth, the stars all rotate around the North Star and as a result, the constellations do not always appear in the same position.

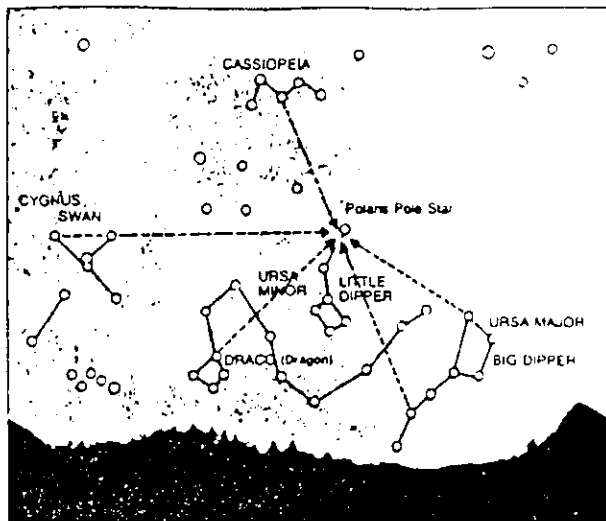

Figure 370 Methods of Locating Polaris

Perhaps the best way to find geographical north from Polaris is to first find the North Star. Then push the longer of two sticks upright into the ground. Place the shorter stick at a point where, when you sight over the tips of both sticks, you hit the North Star. A line scratched between the two sticks is a true north-south line. See Figure 372.

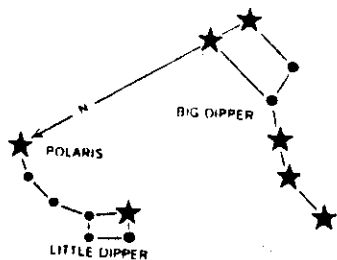

Figure 371 Position of Polaris in Relation to Ursa Major



Figure 372 Using Pointer Sticks to Polaris to Make a Daytime North-South Line

DIRECTIONS FROM ORION

In the northern hemisphere, Orion is a prominent winter constellation and is an old friend of starry nights. This constellation is visible over

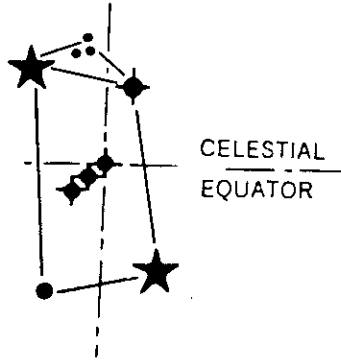

Figure 373 Finding Directions From Orion

most of the globe at certain seasons. It consists of seven stars. The three close together are called the Belt of Orion. The star in the belt through which the north-south line on the diagram in Figure 373 passes is exactly on the Celestial Equator. No matter where on earth you are, this star rises due east of you and sets due west.

FINDING DIRECTIONS BY ANY STAR

Because of the earth's rotation, stars seem to swing across the heavens in great east to west arcs, like the moon and sun. The way in which any star at all is moving at the moment can, therefore, give you a fairly good idea of direction.

Begin by taking a sight on any bright star. You will need two fixed points over which to look, such as two poles driven into the ground for the purpose, their tips lined up accurately as in Figure 374. If you watch a star over these markers for several minutes, it will seem to be falling, rising or swinging left or right.

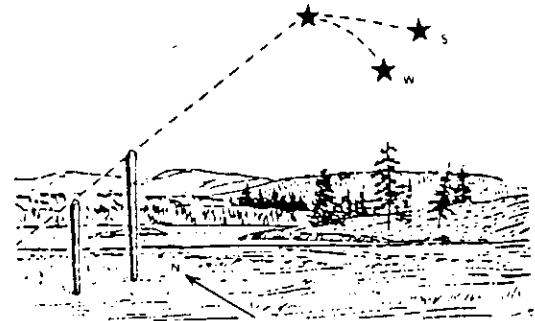

Figure 374 Finding Directions Using Any Star

If the star seems to be falling it is situated just about west of you. If the star seems to be rising it is just about east of you. If the star gives the appearance of looping flatly toward your right, you will be facing approximately south. If it gives the impression of swinging flatly toward your left then you are facing north. Check several stars to be sure and then mark the directions on the ground.

DIRECTIONS FROM THE MOON

The position and shape of the moon can help you find north by showing where the sun is located. See Phases of the Moon, Figure 375.

Face the moon and notice its shape. If it is a new moon, the sun is directly ahead of you, but under the horizon. When the moon is full, the sun is behind you. See Figure 376. When it is a half moon, the sun is on the lighted side. Now point the hour hand of your watch where

Waxing Moon, in moon's first quarter, is illuminated from the right, while the **Waning Moon**, in third quarter, shows half the moon toward the left.

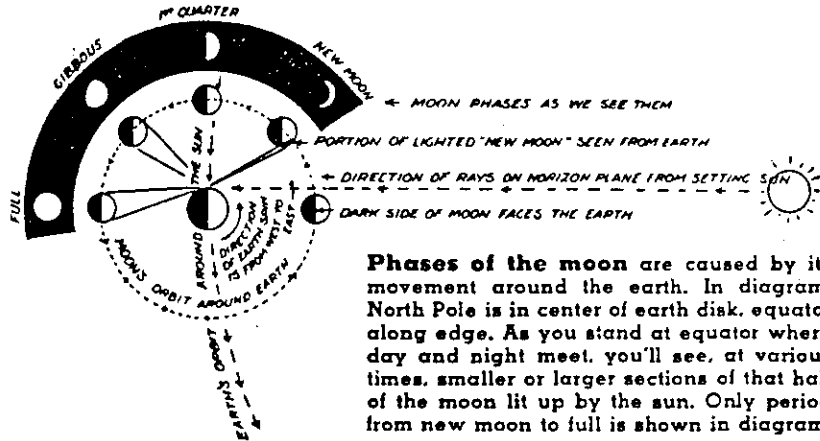

Figure 375 Phases of the Moon

the sun is and do the usual maneuver of finding south by the sun and watch method. Remember, it is the large angle of the watch that must be divided at night to find south.

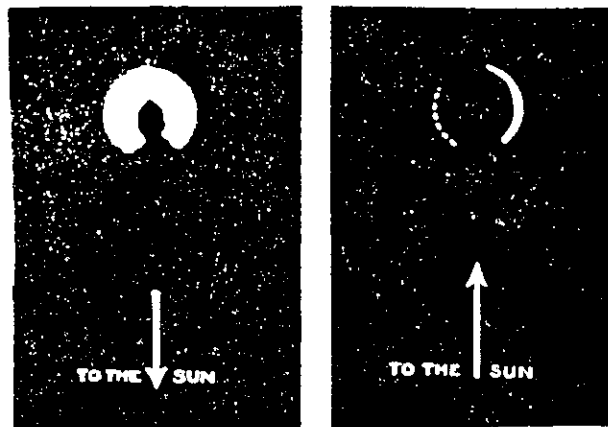
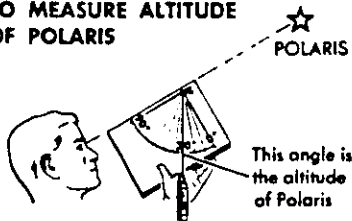

Figure 376 Finding Directions Using the Moon

FINDING LATITUDE FROM POLARIS

HOW TO USE ANY PROTRACTOR TO MEASURE ALTITUDE OF POLARIS



- Any protractor (such as the one printed in AFM 64-5) can be used to find latitude.
1. Attach string with weight to Point "P".
 2. After sighting, grasp string at edge of protractor.
 3. Hold string in this position and take reading. This gives the altitude of Polaris.

You can find your latitude in the northern hemisphere north of 10° North by measuring the angular altitude of Polaris with a protractor as shown in Figure 377. The observed altitude of Polaris is approximately equal to the latitude of the observer. This will be accurate to within 2 degrees, (equivalent to ninety to one hundred miles) under most conditions.

Figure 377 Using a Protractor To Find Your Latitude

TELLING TIME BY DEGREES

Another way of telling time with the sun is with the use of a compass. The sun moves 15° every hour. That is 1° every four minutes. So by calculating the number of degrees the sun is from north, you can tell how long it is before or after midday. For example, if the sun is 40° past north, that is $40 \times 4 = 160$ minutes after midday. In other words the time would be 2:40 p.m.

FINDING THE GEOGRAPHICAL SOUTH POLE

In the southern hemisphere, Polaris is not visible and there is no handy star above the geographical South Pole. There, the Southern Cross is the most distinctive constellation. A line through the long axis of the Southern Cross points to the South Pole. There is no guiding star above it - only a blank space in the sky so dark by comparison that it is known as the "Coal Sack." East of the true Southern Cross are two very bright stars. By using these and the true Cross as guides, you can locate a spot within the Coal Sack which is approximately above the South Pole. This is done by extending a line along

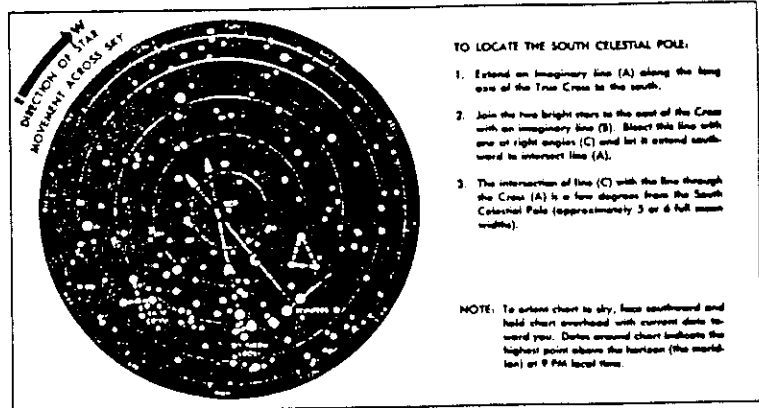

Figure 378 Finding the Geographical South Pole

the long axis of the Southern Cross, to the south. Join the two bright stars east of the Cross by a line. Bisect this line with one at right angles. The point at which this line intersects the line through the Cross is approximately above the South Pole. See Figure 378.

CHAPTER 13

BOOBY TRAPS AND CODES

BOOBY TRAPS

A booby trap is an apparatus or device for the unalert or unsuspecting person, designed to catch him unaware, so as to scare him or trick him. Militarily, they may be an antipersonnel device used to do bodily harm.

Perhaps the simplest booby traps are the exploding fountain pen in which a "cap" goes off, the spring covered "pop out" snake in an innocent peanut butter can with a screw top and, of course, the age old mousetrap.

Usually a booby trap consists of five parts:

1. The bait or trigger, which holds the detonator in check and starts the action.
2. The detonator, which sets off the burst of activity to cause something to happen, such as noise, lights, bells, alarms or buzzers.
3. A power source is needed such as electricity, batteries, springs, twisted rubber bands, etc.
4. The circuit fixtures constitute the arrangement and make-up of the materials which make it work, such as cords, wires and other miscellaneous material.
5. The effect or outcome is what happens, such as a scare, lights, action, noise, etc.

To help explain these five parts, let's look at the three simple booby traps already mentioned.

A. The Exploding Fountain Pen:

1. The pen itself is the bait.
2. The detonator is the fountain pen cover which unscrews.
3. The power source is the spring-hammer apparatus which explodes the cap.
4. The circuit fixtures is the whole pen mechanism.
5. The effect is the firing of the cap and the scare.



Figure 379 Exploding Fountain Pen

B. The Compression Spring Covered "Pop Out" Snake in a Can:

1. The candy-labeled can is the bait.
2. The detonator is the screw-type lid.
3. The power source is the compressed spring snake.
4. The circuit fixture is the coil fitting into the can.
5. The effect is the coiled snake jumping out causing a scare.

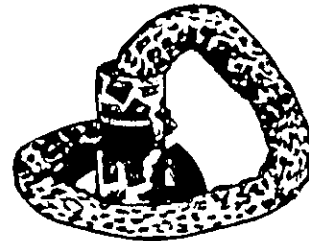

Figure 380 The "Pop Out" Snake

C. The Mousetrap:

1. The cheese on the platform becomes the bait or trigger.
2. The detonator is the holding lever.
3. The power source is the spring.
4. The circuit fixture is the methodical working mechanism of the trap.
5. The effect and outcome is the yoke slamming down to catch the unsuspecting mouse.

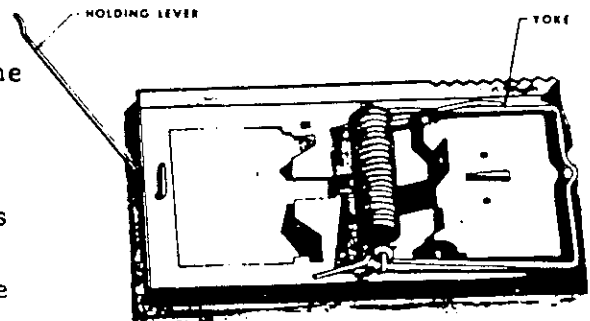

Figure 381 The Mousetrap

There are hundreds of ways to make simple booby traps so that they can be a fun part of a program. They may be used on a booby trap that must be disarmed, or it could be a part of a make believe bomb which must be rendered harmless. Often times a story makes the problem more fun. As an example:

"Your group's mission is to disarm the booby trapped mechanism inside of the box. A red flash of light or a buzzing sound indicates that you have goofed, and as a result, everything will be blown to smithereens. Do your best and happy hunting."

Sometimes the basic parts of a booby trap overlap and the bait, trigger and detonator are difficult to distinguish from one another. Sometimes a simple on/off toggle switch could act as a trigger as well as the detonator because the second the switch is thrown the burst of activity starts.

Perhaps the easiest type of booby trap to make is one having a battery, buzzer and switch. With the host of different switches on the market today such as open and closed contact switches, lever switches, mercury and micro

switches, it is an easy task to open and close circuits in a great number of different ways.

Using a variety of switches or other things such as compression and tension springs, "clip" type clothes pins, modified mousetraps and twisted rubber bands make it easy to design booby traps in which the effect or outcome can be initiated by a detonator consisting of pressure, pressure release, a pull device, pull release, or push device, position variations or multi-actions.

In order to visualize this a little better we will diagram a few simple booby traps that would be easy to make.

1. A "Pressure Device" can be made by punching holes in the end pieces of two #10 cans as shown in Figure 382. An electric lead is fastened to each piece. They are placed with the jagged edges facing each other with a piece of paper between, forming the only break in a circuit connecting a buzzer and a power source. Pressure on the top piece of metal will puncture the paper and complete the circuit, causing the buzzer to go off.

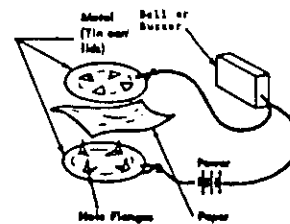

Figure 382 Pressure Device Booby Traps

2. A "Pressure Release Device" can be made by using a mousetrap with the holding lever and bait platform removed. Make a small wooden box with the four sides extending about $\frac{1}{2}$ inch below the bottom of the box. Screw or bolt the mousetrap to the bottom of the box with yoke side away from the bottom. One lead wire has to be attached to the yoke and another lead wire must be attached to a metal plate located on the front of the mousetrap so that when the yoke is against it the circuit will be closed. When the yoke is drawn back to the "setting" position, the box can be carefully set down. The weight of the box will keep the yoke in check, but when the box is lifted it will complete the circuit and the buzzer will go off. See Figure 383.

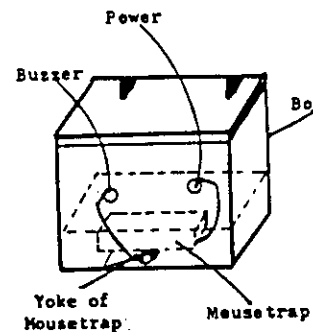

Figure 383 Pressure Release Device Booby Trap

3. A "Pull Device" would be something as simple as an electrical light socket with a pull chain. When the chain was pulled, the circuit closes and the direct current rings the buzzer.

4. A "Pull Release Device" could easily be made with a "clip" type clothespin as shown in Figure 384. The wooden wedge between the contacts of the jaws is the only break in a circuit connecting the buzzer and battery. Pressure on the trip wire pulls out the wedge and completes the circuit causing the buzzer to buzz.

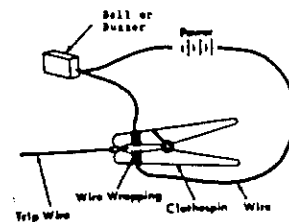

Figure 384 Pull Release Device Booby Trap

5. A "Tension Release Device" can be made by stretching a coil spring and attaching a nail with an electric lead to each end. The nails must be insulated from the spring. Release of the spring will bring the nails together completing the circuit between the buzzer and battery. See Figure 385.

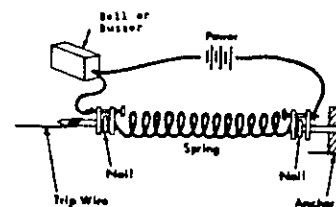

Figure 385 Tension Release Device Booby Trap

6. A "Multi-Action Device" can be made with an open loop as shown in Figure 386. The open wire loop is the only break in a complete circuit connecting the buzzer and the battery. A variety of actions could pull the bare wires together and close the circuit.

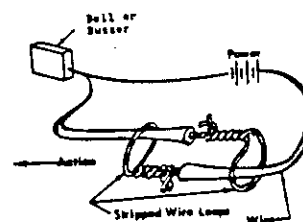

Figure 386 Multi-Action Device Booby Trap

7. Mercury Position Switches make excellent switches to use when doors and lids open from a horizontal to a vertical opening or when things fall from a vertical to a horizontal position. As soon as the liquid mercury gets into the right position, the circuit is closed and the bells will ring.

Adults as well as kids enjoy trying to "disarm the bomb" as they watch the seconds tick away on a timer. This makes a "fun" program.

When making booby traps for fun, one idea leads to another and before you know it one can come up with some excellent games for fun.

CODES, CIPHERS AND SECRET MESSAGES

Cryptography is the enciphering and deciphering of messages in secret code. Technically speaking, a code is a system of symbols such as letters, numbers or words used to represent assigned and often secret messages, whereas a cipher is a method of transforming a text in order to conceal its meaning. In any event, both ciphers and codes are secret messages, so let's begin this chapter with a secret message.

1. DV SLKV BLF VMQLB XLWVH ZMW HUXIVG DIRGRMT
2. W H E E C N
E P U Y A R
O O O S C R
Y J E E W I
N D S T T G
O D E I N S
3. W Y O S C I
E O Y A R T
H U C N E I
O E O D T N
P N D S W G
E J E E R S
4. 4-22 19-12-11-22 2-12-6 22-13-17-12-2 24-12-23-22-8 26-13-23
8-22-24-9-22-7 4-9-18-7-18-13-20-8
5. 23-5 8-5-16-5 25-15-21 5-14-10-15-25 3-15-4-5-19 1-14-4
19-5-3-18-5-20 23-18-9-20-9-14-7-19
6. . _ _ . / _ _ _ . _ _ . . / _ _ . _ _
_ _ _ . . _ _ / . _ . . _ _ _ _ _ _ _ _ . _ _ _ /
_ _ _ _ _ / . _ _ . _ /
. _ . _ . . . _ _ / . _ _
_ . . _ . _ _ /
7. EW EPOH UOY YOJNE SEDOC DNA TERCES SGNITIRW
8. WRITINGS SECRET AND CODES ENJOY YOU HOPE WE
9. SGNITIRWTERCESDNASEDOCYUJNEUOYEPHEW
10. WEH OPEYO UENJ OYCO DESA NDSEC RETWRI TINGS

Cipher #1 is merely one letter standing for another. In this case D's are W's and V's are E's etc. Cipher #2 is putting the message into block form and is read diagonally up and to the right. Cipher #3 is the same except it is read from top to bottom and left to right. Code #4 and #5 is just a matter of transposing numbers in place of the alphabet. Code #6 is in Morse Code. It is shown in complete form in Figure 387. A simple Morse sending and receiving system is shown at the end of the chapter.

Letters					
A	di-dah	--	M	dah-dit	--
B	dah-di-di-dit	---...	N	dah-dah-dah	-----
C	dah-di-dah-dit	---..	O	di-dah-dah-dit	---..
D	dah-di-dit	---.	P	dah-dah-di-dah	-----
E	dit	.	Q	di-dah-dit	---.
F	di-di-dah-dit	---..	R	di-di-dit	---.
G	dah-dah-dit	---.	S	di-di-dit	---.
H	di-di-di-dit	---...	T	dah	--
I	di-dit	..	U	di-di-dah	---.
J	di-dah-dah-dah	-----	V	di-di-di-dah	---...
K	dah-di-dah	---.	W	di-dah-dah	-----
L	di-dah-di-dit	---..	X	dah-di-di-dah	---...
M	dah-dah	---	Y	dah-di-dah-dah	---...
			Z	dah-dah-di-dit	---..

Numerals					
1	di-dah-dah-dah-dah	-----	5	dah-di-di-di-dit	---...
2	di-di-dah-dah-dah	---...	6	dah-dah-di-di-dit	---...
3	di-di-di-dah-dah	---...	7	dah-dah-dah-di-dit	---...
4	di-di-di-di-dah	---...	8	dah-dah-dah-dit	---..
5	di-di-di-di-dit	---...	9	dah-dah-dah-dah-dit	---...
			0	dah-dah-dah-dah-dah	-----

Figure 387 The International Morse Code

Cipher #7 and #8 have the words and message backwards, whereas Code #9 has the message running together backwards. Code #10 is just the separation of words at any convenient point.

The above cryptograms (a communication in secret code) are some of the ciphers and codes that one can use which don't take too long to decipher. The secret messages listed above are excellent for 15 to 30 minute programs. Several different ciphers can be used in the same problem.

If you get more deeply involved in codes such as using a Code Wheel as shown in Figure 388 or if you use a code such as in Figure 389, both the person doing the enciphering and deciphering would need a code book which contained a list of words or expressions with their code group equivalents. This would be more for repeated communications back and forth between two or more parties.

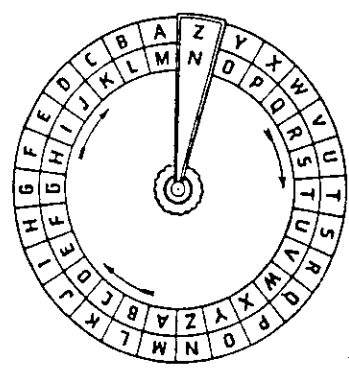

Figure 388 Code Wheel

A	#	J	#	S	#
B	#	K	#	T	#
C	#	L	#	U	#
D	#	M	#	V	#
E	#	N	#	W	#
F	#	O	#	X	#
G	#	P	#	Y	#
H	#	Q	#	Z	#
I	#	R	#		

Figure 389 Personal Code

So, the best rule for smaller groups is to keep it simple and make it short. One can certainly see the difference in enciphering and deciphering columns 2 and 3 as opposed to columns 4 and 5 in Figure 390.

An improvised code such as in Figure 391 is a fun code to work with but as a general rule it is too time consuming to use in short problems. This is also true if you try to use the hand alphabet for the deaf and deaf-mute persons as shown in Figure 392.

A	1	Z	☉	J
B	2	Y	☽	J
C	3	X	☾	J
D	4	W	☿	J
E	5	V	♁	J
F	6	U	♂	J
G	7	T	♃	J
H	8	S	♄	J
I	9	R	♅	J
J	10	Q	♆	J
K	11	P	♇	J
L	12	O	♈	J
M	13	N	♉	J
N	14	M	♊	J
O	15	L	♋	J
P	16	K	♌	J
Q	17	J	♍	J
R	18	I	♎	J
S	19	H	♏	J
T	20	G	♐	J
U	21	F	♑	J
V	22	E	♒	J
W	23	D	♓	J
X	24	C	♈	J
Y	25	B	♉	J
Z	26	A	♊	J

Figure 390 Secret Code Panel

A	□	J	△	S	┆
B	□	K	▽	T	□
C	□	L	▽	U	□
D	▨	M	▽	V	▨
E	▨	N	○	W	▨
F	▽	O	⊖	X	×
G	△	P	⊖	Y	┆
H	△	Q	⊕	Z	┆
I	△	R	○		

Figure 391 An Improvised Code

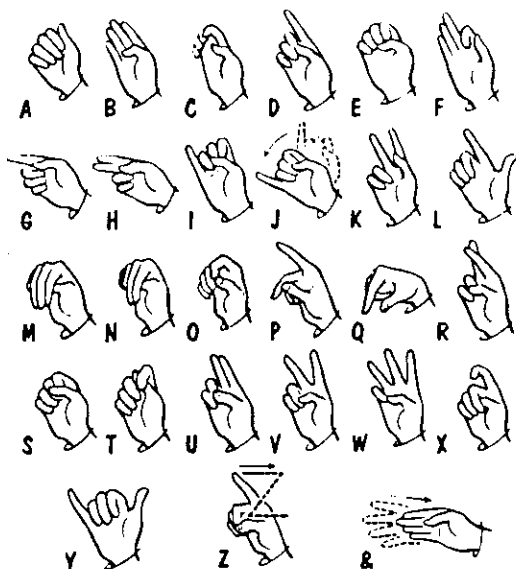

Figure 392 Deaf-Mute Hand Alphabet

Before leaving the subject of secret writings, we want to jot down a few ideas on invisible writing. First of all, there are many compounds that may be used for secret writing, but it usually takes another compound to develop or bring out the letters. As an example, a teaspoon of copper sulfate in a glass of water may be used as an invisible ink. In order to develop the letters, you must put the message into a solution of sodium carbonate which is plain washing soda in a solution of two teaspoons to a glass of water. The ink develops into a light blue color. These two chemicals are safe, cheap and easy to get for ordinary use in secret writing.

Developing may be done in several ways. The message may be laid face up in the developing solution. The paper should not be moved. The reaction takes place quickly and the paper can then be lifted out and laid face up on a sheet of newspaper. Another method would be to dab on the developer with absorbent cotton (do not rub). Still another method

would be to spray the developing solution on with an old atomizer or spray bottle. If you want to keep the message, you can blot off the excess developer carefully or else just let the paper dry slowly.

In writing secret messages, use an old fountain pen or some other pen with a smooth point. Do not use a scratchy pen and try to avoid ordinary steel pen points. The iron in them may react with the chemical ink and spoil the results.

A message written carefully with invisible ink cannot be detected even when held up to the light or otherwise examined.

As mentioned above, there are many chemicals you can use for invisible writing, but each chemical needs its own developer, so this becomes a major disadvantage. Liquids spill, clothes get soiled, and you need clean containers for the solutions, so using chemical solutions can become cumbersome.

A much better way of using invisible writing is to use some of the ordinary household liquids. This is a group of invisible inks which need

no chemical as a developer. Instead, just plain heating of the invisible ink message makes the writing appear. These heat-sensitive inks are the easiest to find and use:

1. Milk used directly. Ordinary cow's milk, goat's milk, buttermilk or evaporated milk may be used. Avoid cream, as fat stains may result.
2. Sugar: Use a dilute solution of one teaspoon of sugar to a glass of water.
3. Lemon, grapefruit, or orange juice all work well.
4. Onion juice gives excellent results.
5. Apple juice works too, but not as well as the citrus juices.
6. Honey: A teaspoon of honey in a glass of water gives results very similar to sugar.
7. Coca Cola and other similar drinks containing sugar can be used. If color shows in writing, dilute with water.
8. Vinegar used directly makes an excellent invisible ink.
9. A solution of one teaspoon of salt to a glass of water works quite well.
10. Bicarbonate of soda: One teaspoon to a glass of water also makes a good invisible ink.

Developing an ink with heat raises another problem which cannot be overlooked. Just a moment's carelessness and you will have a bonfire instead of a decoded message. Heating requires care. If possible, use an electric hot plate, an electric iron or even a large electric light bulb (200 watts) as shown in Figure 393. The next best thing to use is a gas stove. A large source of heat is better than a candle or match.

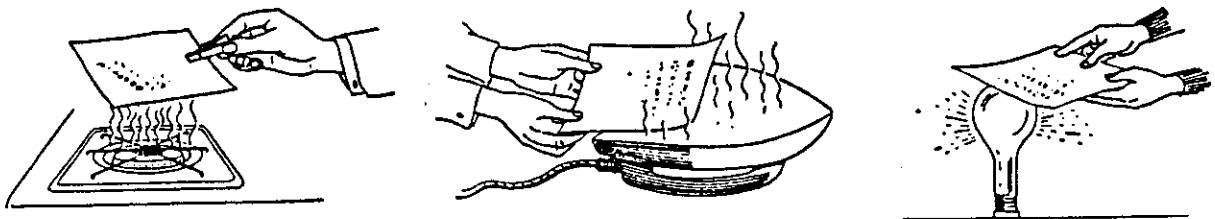
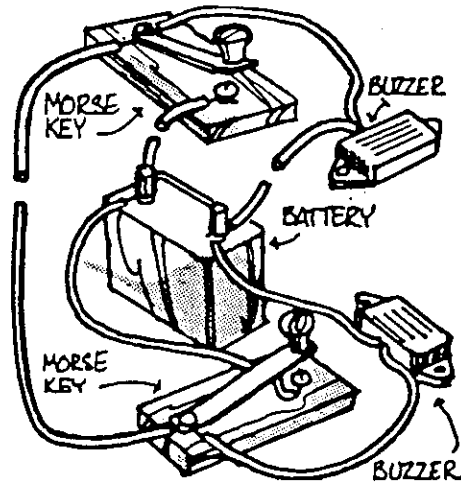

Figure 393 Developing Ink With Heat

In heating a message keep the paper moving at all times, moving it nearer to the heat source as needed.

Boys, girls and adults all like to use their wit to solve a problem in which a secret message is contained in some way.



A Simple Morse System

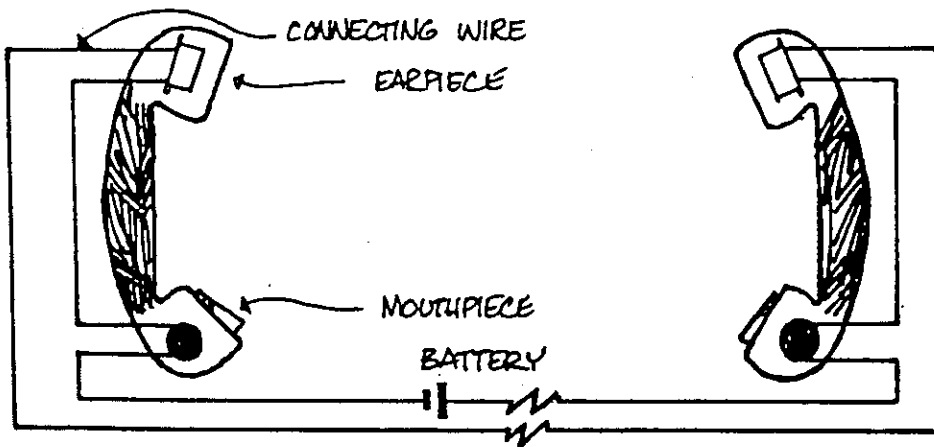

A Simple Telephone System

CHAPTER 14

DEMONSTRATIONS AND LEARNING EXPERIENCES

Perhaps one of the most continuous needs of a group leader is the want and need for good program material. The more variety and action that can be used, the more interesting and positive the program becomes.

Program material can be of any length - from a few minutes to a full day, a weekend or even longer. Then, of course, shorter programs can be made into longer ones by setting up a series of activity stations, each station lasting for a specified time. As an example, a leader could select 12 activities. If he or she thought the group could complete each station activity in 15 minutes, a three hour half-day program could be used up very easily. If the group was as large as 96, every eight persons could be put into one of the 12 groups. By using a "round robin" method, a leader could keep all 96 people busy at the same time, providing he had a staff person to direct each of the events at the 12 stations. Care would have to be taken that each of the 12 events lasted about the same length of time. Each station would have to start and end at the same time so each of the 12 stations could rotate simultaneously.

How long it would take various groups to complete the program activities could depend on the number in the group, their ingenuity, knowledge, experience and the amount of help they would be given by the staff. Staff personnel would be needed to direct and, if necessary, judge the event.

To help categorize the subsequent program material, we will classify the program ideas into three groups: Demonstrations and Learning Experiences, Group Challenges and Hypothetical Problems.

Most of these learning experiences are designed to last from about 10 to 30 minutes depending on how involved you wish to become with the particular events. All programs are designed for small group participation - usually four to eight people.

In the category of Demonstrations and Learning Experiences, almost any subject can be used for a 10 to 30 minute period of teaching, demonstration, discussion or review. The main thing is to get the important points of a subject across to the group so they can learn what it is, what it does, how it works, how to do it, etc. These activities may include such things as:

1. Displaying and knowing the different types of knives, axes or saws.
2. The nomenclature of knives, axes, saws or tools.

3. The care and safety of knives, axes or saws.
4. The sharpening procedures for knives, axes, saws or tools.
5. The identification, care of, and use of various other woods tools.
6. Whittling gadgets with a knife.
7. Throwing the sheath knife.
 - a. Use an old sheath knife for target practice, preferably one with a blade which will bend rather than break. A cheaper knife is usually better than a more expensive knife because of the fact the blade has less temper in it.
 - b. There must be a definite distance between the knife thrower and the target. Start with 7 paces. This distance may be increased or decreased one pace at a time until you find your throwing distance.
 - c. Hold the spine of the knife in your closed hand with the thumb along blade pointing toward the handle or grip of the knife. Keep the fingers bent inward so that they are well away from the edge of the blade. The thumb can rest against the hilt of the knife. Some beginners prefer a glove, but it is not necessary.
 - d. Throw the knife overhand as you would throw a baseball.
 - e. If you are right-handed, hold the knife in the right hand. Have the left foot slightly ahead of the right with the body and feet facing at a 45 degree angle to the right of the target. As you throw your body weight forward, step out with the left foot, throw your right arm towards the target letting the knife slide from your hand towards the target.
 - f. With a little practice you can become quite accurate.
 - g. A good target can be made by making a four foot square from planking. Be sure the area around and behind the target is free from people and other objects which could be damaged.
8. Make a fuzz stick which was used in yesteryears for starting a fire. Today, fuzz sticks are rarely used, but the art of making them should not be forgotten. Secure a stick of dry soft wood which is about a foot long and an inch thick. Point the end as shown in Figure 394-A. While holding the pointed end place the other end against something solid and whittle long slender shavings as long and as thin as possible, leaving them attached to the stick. To prevent the shavings from being cut loose, press harder and deeper with the knife as the end of the cut is neared. When finished the fuzz stick will look like a Christmas tree. Then the pointed end of the stick is

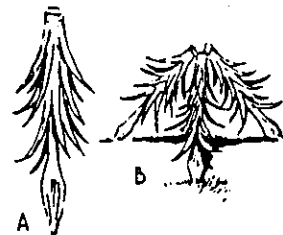

Figure 394 Fuzz Stick

placed into the ground and small kindling is piled around it and it is ready to light. If desired, three fuzz sticks may be made and they can be placed into the ground teepee-fashion as in Figure 394-B.

9. Log chopping contests: Use a log 16 inches in diameter for adults and a log 8 to 10 inches in diameter for youngsters. See who can produce the biggest chips.
10. Log Throwing (Caber Tossing) Contest: This activity consists of throwing a log. This is done correctly by holding the butt end of the log in your two hands with the top end of the log up over one of the shoulders as shown in Figure 395. When one feels up to it, the log is tossed up and over to the rear of the individual.



Figure 395 Log Throwing
(Caber Tossing)

11. Log Twitching Contest: This is an exercise in which a large log is pulled on the ground by a group with a rope. The rope is attached to the log with a timber hitch and a simple hitch if needed. See Figure 396.

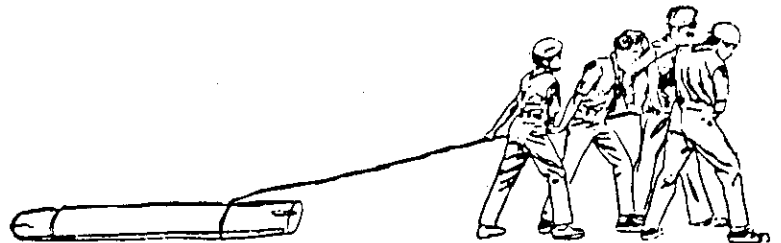

Figure 396 Log Twitching (Log Pulling)

12. Log Bouncing Contest: This contest is one in which a log is held overhead by 4 to 8 people and, in cadence, they bounce the log up and down over their heads as shown in Figure 397.



Figure 397 Log Bouncing

13. Aerial Torpedo Contest: This contest is again used with a team of 4 to 8 people over a prescribed course. The log is held by

all players with both hands above their heads. The log is then moved forward, the person at the rear running forward as it passes out of his hands, to take it up again at the front. It is important that no one moves their feet, even fractionally, while in contact with the log. This requires a lot of self discipline of a high order. See Figure 398.

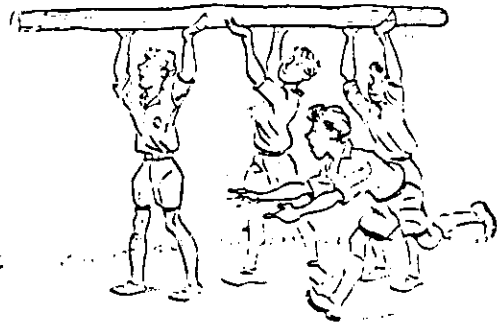

Figure 398 Aerial Torpedo

14. Log Splitting Contest: Log splitting should be done with two axes or a couple of gluts and a beetle as shown in Figure 399. The splitting should always be started at the smaller end of the log. If two axes are used, drive one axe in the side of the log near the end and drive the second axe in the same crack a few inches farther along with its handle in the opposite direction. The second axe should free up the first axe which is withdrawn and driven in again farther down the log, repeating this process until the split has been carried the entire length of the log.

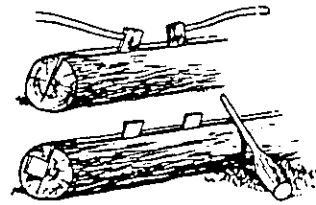

Figure 399 Log Splitting

15. Log Carrying Contest: Carry a log in improvised telegrips over a certain course. See Page 51.
16. Explain and demonstrate the contact method of chopping.
17. Debark or hew a downed tree trunk with an axe, adz or broadaxe.
18. Lop the branches from a downed tree.
19. Differentiate and discuss the handaxe, hatchet and half-hatchet.
20. Have a handaxe or tomahawk throwing contest: The scout handaxe is the ideal throwing axe. At five steps (not strides) away from the target, it will revolve once and stick. Stand at this distance, your feet squarely on the ground with the left toe slightly in advance of the right, and grip the axe in your hand as near to the end of the handle as possible. Then hold it upright in front of you and steady it with the left hand, keeping it straight up and down, tilted neither to the right nor left. Remove the left hand, draw the axe back without tilting, and throw it straight at the target, at the same time stepping forward with the left foot. It should make one revolution and stick.

The knack will come with time, but if the axe seems to behave right but still does not stick, experiment by changing the distance from the target a few inches until the proper throwing point for you is achieved.

Try to keep the target low so you are throwing the axe downward. This is a good safety measure. Axe throwing can be fun but like anything else it can be dangerous if not done properly, so be careful. Spectators should always stand behind the person who is throwing the axe, not to one side of him. The axe, when thrown, may rebound from the target or glance back so care must be taken. The person who throws the axe should be allowed to retrieve his own axe and return to the throwing line before another axe is thrown. Tomahawks may be purchased at certain mail order houses and sports stores. The tomahawk is thrown just like a handaxe.

21. Have a saw versus an axe on a log cutting contest.

22. Log Sawing: Find a two-man crosscut timber saw. Cut a piece of log for speed, an exact length, weight, the thinnest slice or a given angle, etc. See Figure 400.



Figure 400 Log Sawing

23. Use a one-man crosscut saw in the same manner.

24. Have a bow saw relay.

25. Make music with a hand saw.

26. Make camp gadgets and rustic furniture.

27. Differentiating and making piles of tinder, kindling and fuel.

28. Have a relay using a bow saw "Swedish Style." See Figure 401.



Figure 401 Using a Bow Saw Swedish Style

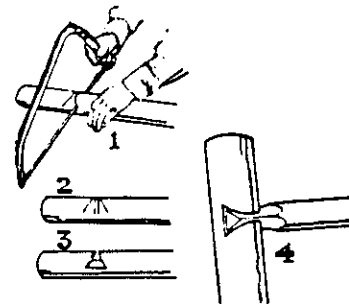

Figure 402 The Dove Tail Notch

29. Make a Dove Tail Notch: See Figure 402. Dovetailing is a simple cabinet maker's craft for holding two pieces of wood together. If you wish to hold two poles together at right angles, and if you have no nails and a hammer, or lashing ropes, you may make what is called a dove tail notch. This type of a notch was used in the chapter on rafting in Figure 305.

A dove tail notch may be made with only four or five cuts by a saw and a few strokes with your knife. The notch will hold slender unshaped round sticks for quick work and thicker tight-fitting dove tails for heavier loads.

Make two slanting equal cuts, one to the left and one to the right so that the two cuts are almost at right angles to each other. Another cut may be made straight down to the depth of the side cuts. This cut makes it easier to pry out the wood from the notch. With the piece to be fitted held over the notch, shape the base and sides being sure to make the end a little smaller than the notch. The dove tail may then be driven into the notch until it jams into place. If you want a stronger joint, shape the dove tail so that it fits through the notch.

30. Have a relay with a post hole digger.
31. Move logs with a peavey, cant hook, or hookaroon
32. Use a block and tackle to lift a weight.
33. Tighten a rope with a block and tackle.
34. Utilize the block and tackle as a self lifting hoist.
35. Use a log as a lever for lifting a car or other heavy object.
36. Use a parbuckle for rolling a log up and down a steep incline.
37. Use a parbuckle for lifting a barrel or other weight.
38. Make and use a gin pole.
39. Make and use an A-Frame, shear legs or a tripod.
40. Make a windlass that works.
41. Build an improvised derrick.
42. Make a totem pole.
43. Make and use a runway.

44. Use a gun tackle in competition for rolling a log. See Figure 403-A. A second type of gun tackle is shown in Figure 403-B.

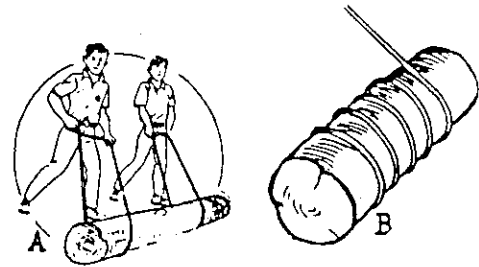

Figure 403 The Gun Tackle

45. Make a Swiss seat from a 20 foot piece of webbing.
46. Make and use toggle ropes.
47. Name, show and review the types of natural and synthetic rope.
48. Show the difference between right and left handed lay rope. Show and explain the difference in woven and twisted rope and solid and tubular braided rope.
49. Make a rope from binder twine using three different methods.
50. Whip a rope using each of the whipping methods.
51. Learn to tie and identify knots using each knot for a purpose.
52. Make an end or back splice.
53. Make an eye splice, short splice and long splice.
54. Make a Docker's Eye splice.
55. Make a tripod with a sailmaker's 3 pole lashing or tripod lashing.
56. Make a quadropod using a sailmaker's 4 pole lashing.
57. Make a shear legs using a shear lashing.
58. Extend poles with the round lashings.
59. Lash poles together using one of the square lashings and have a relay race.
60. Identify several types of artificial and natural anchorage.
61. Show the use of the double butterfly-Prusik tightening arrangement.
62. Show how to use the harvester's hitch.
63. Show and use three rescue knots.
64. Make and use a one rope bridge.

65. Make a two rope commando bridge.
66. Make a three rope monkey bridge.
67. Improvise a seat harness.
68. Climb a rope with one or more of the following methods:
 - a. Free climb
 - b. Using man overboard knot
 - c. Using chocks
 - d. Using sticks
 - e. Using the footlock
 - f. Using the overhand loop knots
69. Make a ladder using rungs and the marline spike hitch.
70. Climb a 12 foot pole using the Prusik knots.
71. Use the Bachmann knot to climb a pole.
72. Make a horizontal traverse and cross it with one or all of these methods:
 - a. British crawl
 - b. American crawl
 - c. Tyrolean traverse and a bowline on a bight
 - d. Step slide
 - e. Using a pulley and a Spanish bowline.
73. Make a Boatswain's chair (See Figure 404) and cross a horizontal traverse.
74. Use a grappling hook to help climb a tree or wall.
75. Use a grappling hook to get a "first line across."
76. Teach or learn rappelling and belaying.
77. Teach or learn the art of tension climbing.
78. Learn to differentiate different kinds of maps.
79. Get acquainted with the five zones of the earth, longitude and latitude.
80. Teach or learn the marginal information on topographical maps.
81. Be able to read and explain contour lines.
82. Know the topographical map symbols.

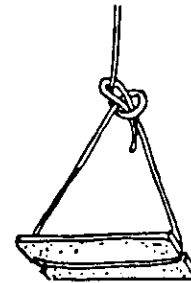

Figure 404 Boatswain's Chair

83. Orient a map in the field and use a land compass.
84. Differentiate grid north, compass north, magnetic north and true north.
85. Solve mapping problems using distances, degrees, symbols, directions, destinations, etc.
86. Know about townships, sections and acres.
87. Using a topographical map, protractor and ruler set up a course on the map and have another follow your course on another identical map.
88. Box a compass.
89. Explain declination, deviation and compass error.
90. Make a compass using several different methods.
91. Know the estimated walking and running speeds in various terrain.

92. Play the compass triangle game (the equilateral triangle). Play the game by putting a small object such as a coin on the ground. Set your compass at any degree bearing less than 120° (as an example, 40°). Walk for 200 steps following the 40° . Add 120° to the original degree reading and reset your compass (in the example this would make it 160°). Walk 200 steps in this new direction. Again, add 120° to the second degree reading (this would make it 280°). Reset the compass and walk another 200 steps in this third direction. Stop. Bend over and pick up your coin. See Figure 405.

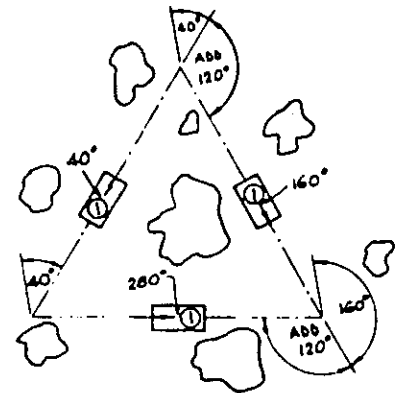

Figure 405 Compass Triangle Game or Equilateral Triangle

93. Differentiate and know how to use the dial and needle land compasses.
94. Set up and take a bee-line compass course.
95. Do some orienteering and know the different types.
96. Set up a course to measure your pace.
97. Estimate distances by pacing off known distances.

98. Try finding a buried treasure by compass.
99. Use the compass to tell the time of day.
100. Take several back readings on a compass.
101. Show how to refind a favorite fishing spot on a small lake by using a land compass.
102. If near the water, build several types of floatation devices.
103. Build a coracle, bull boat or brush raft.
104. Check the rate of speed of a stream.
105. Make a display of fire lays and fire places.
106. Explain the specific uses of various fire places.
107. Bake biscuits in a reflector oven.
108. Cook a meal in a steam pit.
109. Make an imu or make and use an above-the-ground pit.
110. Describe the fire triangle and give several reasons why we need fire.
111. Build and use a buffalo fireplace.
112. Make an altar fire.
113. Differentiate a log cabin, a criss cross fire and a friendship fire.
114. Figure out your personal measurements.
115. Discuss some of the things that must be remembered when measuring distances.
116. Estimate distances by sound.
117. Estimate the number of words on a page.
118. Estimate the time of sunset using the finger method.
119. Estimate heights using four different methods.
120. Estimate widths of various things.
121. Explain the various methods to find north, east and south.

122. Estimate directions using Polaris.
123. Estimate directions using any star.
124. Estimate directions using Orion.
125. Estimate directions from the different phases of the moon.
126. Learn the constellations.
127. Explain how you can determine your latitude in the Northern Hemisphere.
128. Explain how to find the geographical South Pole if you were in the Southern Hemisphere.

129. Play Kim's games:

Rudyard Kipling was a British author. One of his first novels was entitled "Kim," which was the story of a poor boy from India who had excellent powers of observation, so he was trained to be a member of the British Secret Intelligence. As a result, he taught himself to observe and remember. From this novel, "Kim's games" were developed in which the five senses are used to help sharpen the wits by sensory perception and memory: Observe and identify, feel and identify, smell and identify, listen and identify and taste and identify.

The variations to this game are unlimited. The game can be as simple as observing a string with 15 small things tied to it for a minute and when the string is taken away the items must be identified. A number of articles may be observed. Then the articles taken away from view and articles may be transferred, removed, added and substituted. The group again observes the articles to guess what changes were made. Then up to another 15 objects may be felt while blindfolded and then identified. Small canisters of household products may be identified by smell or taste. A tape with several different sounds can be played on a tape recorder and then identified. If a tape recorder is not handy the leader may go behind a screen and strike a match, use a zipper, drop a coin, crumble a sheet of paper, etc. All of these things make good short programs and they can be varied endlessly. Follow a trail and see what the leader has lost along the way. Observe 25 things for one minute and then remove two of the items and have the group tell which two items were removed. A "salesman" comes in and shows the group 15 things that he sells, and then he packs them up and leaves. What was the salesman wearing? Ideas for this game go on and on.

130. Explain buoyancy, draft and expedient floatation devices.
131. Discuss how to cross a narrow stream with a swift current.

132. Explain and demonstrate how to make water wings.
133. Review the different types of brush rafts.
134. Try building a flying ferry or a raft using pendulous action.
135. Discuss Bushcraft and what it means.

As you can see, the list of discussion topics is without end. As stated before, these topics may be used to teach small groups an art or craft as a learning experience. They can be used for discussion and review and best of all, these things can be learned by the participants actually doing the various skills. They are taught the subject, they practice doing it and then they can put it to actual use or into practical application. Many of these ideas can be used in games, competition, relays or contests.

As you can see, the rest of this page has been left blank for you to fill in other subjects that may be of interest to you. As you go about your daily tasks, you sometimes are confronted with an idea that you would like to jot down for future reference. This is the place to jot it down.

136. _____
137. _____
138. _____
139. _____
140. _____
141. _____
142. _____
143. _____
144. _____
145. _____
146. _____
147. _____
148. _____
149. _____
150. _____

CHAPTER 15

GROUP CHALLENGES

Group challenges are skills, crafts and problems. They are inspirations, inventiveness and ingenuity. It's a method of using your imagination and intelligence. They are initiative tests, learning experiences and just plain fun things for small groups. Some group challenges need prior knowledge on a subject before the challenge can be done; however, many of them require no prior training.

Many of these challenges could be set up for a half day or a full day's project as an adventure trail. This type of program is excellent to teach leadership, teamwork, achievement and timing.

The rest of this chapter contains 75 group challenges. They range from the difficult to the sedentary; from the sublime to the ridiculous, but they are all fun. Try them.

1. Handicapped: Have your group pitch a tent while blindfolded. Use two cotton balls held on by masking tape for blindfolds.
2. Stream Race: Have a stream race where groups race against each other for 300 yards in a stream.
3. Lost Child Search: Have a mock search in the woods for a large doll. Bring the doll out on an improvised stretcher.
4. Realistic First Aid: Have some realistic first aid problems. Realistic first aid may be enhanced by making realistic wounds. Blood may be made from red food coloring, cocoa and water. If you like a thicker blood, use red food coloring mixed with cold creme. To make wounds, use morticians wax. If you wish to make first degree burns or inflamed areas, rub in red lipstick with your finger. Second degree burns are denoted by blister formations. Blisters may be simulated by drops of wax on the skin. For third degree burns, use a black grease pencil, apply rubber cement freely over the area, and then loosen small tags of the cement so it will look like charred flesh. Bottles with a "plunger" top attached to small rubber tubing makes a good replica of arterial bleeding or spurting blood.
5. Wild Edible Plants: Find someone who knows wild edible plants and arrange a short hike to identify, gather, and prepare a wild edible plant lunch.

6. Blind Obstacle Course: A blindfolded group follows a twine obstacle course through the woods.
7. Coded Treasure Hunt: Try a coded treasure hunt with several different codes.
8. Metal Detector: Borrow a couple of metal detectors and have a group find a special metal piece in a 20 foot square.
9. Age: Find something young and something old.
10. Improvised Spears: Throw improvised spears through a moving hanging tire.

11. Summer Snowshoes: Build a couple of pair of "summer snowshoes" out of 1 inch by 8 inch lumber. These snowshoes can be built long enough to carry eight people or as few as one. See Figure 406. Race two or three groups together and you will see this exercise is excellent for building coordination.

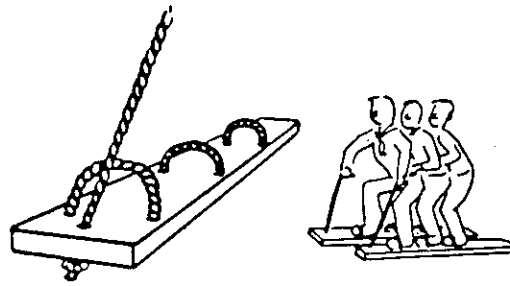

Figure 406 Summer Snowshoes

12. Egg Drop: Have a race between two groups to see which group can drop an egg from six feet up, down onto a concrete slab without breaking it. Grass, weeds or clothing, etc., may be used for padding.
13. Rainstorm: Have a group start a fire in the rain. If there is no rain, try shooting the water from a hose so that it drops into a ten foot circle where the fire must be made.
14. Operation Blue Dogs: Have a small group guard a small tent with water pistols. Each of the opposing group is armed with a piece of chalk. The object is to put a chalk mark on the tent without getting hit by the water from the squirt guns.
15. Sling Shots: Make and use sling shots with still or moving targets.
16. The South American Bolas: Make Bolases and use them for target practice on a couple of stakes that have been driven into the ground. The stakes would represent larger animal legs.
 A bolas is a primitive weapon consisting of a stone, or other heavy object, securely fastened to the ends of 1 to 6 ropes about three feet long. It is used for throwing and entangling an animal's legs or waterfowl.

Bolases were used on the pampas of many South American countries, by the Indians of North America and by the Eskimos.

The South American bolas usually consisted of several rawhide cords or ropes (3 to 6) which were about three feet long. The free ends were tied or braided together and used as a handle. The thrower whirls the weapon over his head, takes aim, and hurls it at a rushing long legged animal. If successful, the stones would wind the ropes around the animals legs and throw it to the ground. The animal could then be captured or killed and used for food.

The North American Indians also used the bolas to capture waterfowl.

The Eskimos used a bolas which consisted of a cord of rawhide about six feet long with a weight secured to each end. The middle of the rope was then grasped by the hand, whirled and thrown.

17. The Sling: Make and use a sling for target practice. A sling is another primitive weapon which one can have a lot of fun with but it takes a lot of practice to become accurate with it.

A sling can easily be made with two strips of leather or a couple of tough leather boot laces tied to a soft leather cup which is used to hold the stone. If nothing else is available, the tongue of a boot may be used. To be most effective, the piece of cupping leather should be made as shown in Figure 407 with a diamond

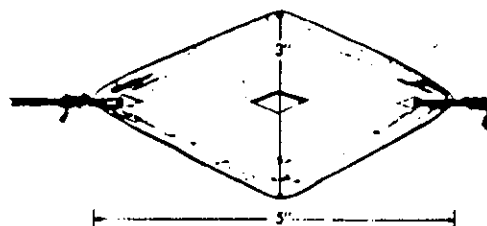

Figure 407 Cupping Leather For a Sling

shaped hole in it which holds the stone more securely. The leather thongs should be a little over two feet long and tied to the leather stone-cupping device. One of the thongs should have a loop in the end of it which can be put around the wrist or middle finger. This will hold the sling to your person after the throw.

To use the sling, a right-handed thrower should attach the loop to his right middle finger or wrist and load the leather cup with an egg sized rock. Then the other thong is taken between the thumb and index finger so that the thongs are the same length and the stone in the cupped leather piece holds the thongs taut. The sling is then whirled around the head at arm's length. Centrifugal force will hold the stone in the cup. After 3 or 4 whirls, let the loose thong fall from your fingers. This whips the stone forward with a lot of force.

18. Azimuth to Treasure: Have a four-leg compass course laid out with known distances between each of the four bearings. Have the group take the bearings from the starting point, pace off the distance to each remaining bearing and find the treasure.

19. Scavenger Hunts: These are always a quick way to put part of a program together.
20. String Burning Contest: This may be done in many ways. Figure 408 shows a few different ways of setting one up.

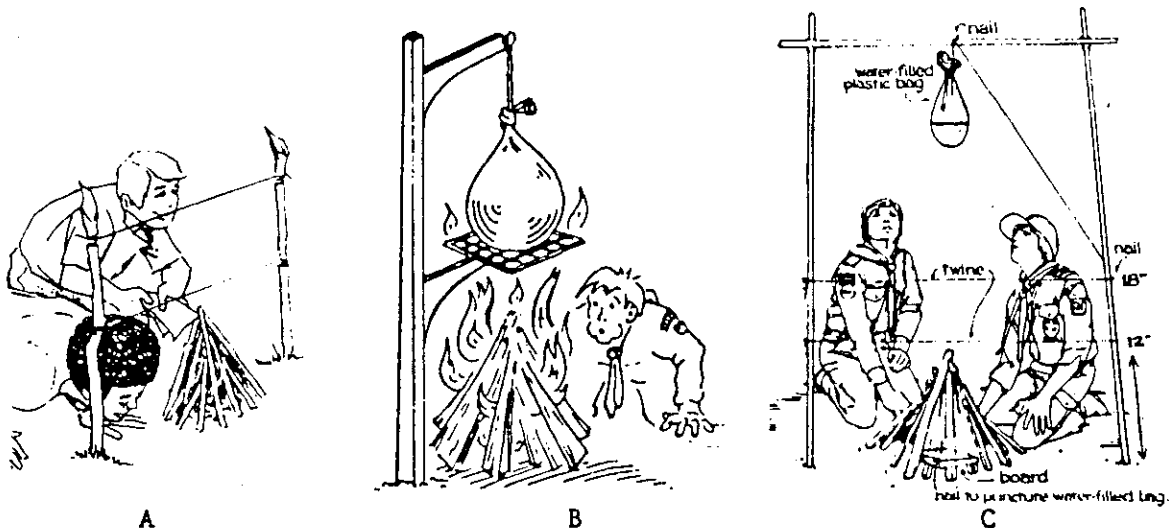

Figure 408 A String Burning Contest

21. Prepare an Egg: Have your group build a fire and roast an egg on a spit by tapping spit holes into the ends of each egg and driving a small spit through the egg, boil an egg in a paper cup of water, bake an egg in mud, and cook an egg in half an orange peel.
22. Water Shortage: Have your group build a fire, strain, boil and aeriate a pan of water so as to purify it for drinking.
23. Lift the Heavyweight: Lift the heavyweight of your group by building a large tripod. At the apex of the tripod attach a galvanized fast eye pulley or single sheave block with a hook or eye. A $3/8$ inch rope is run from the pullers up through the block and extends to the ground. A large bowline loop is put in the end of the rope so the heavyweight may stand in the loop and while holding on to the rope going up to the sheave, his comrades can hoist him to the top of the tripod where, if desired, a bell may be attached that the heavyweight may ring. It makes a good timed event.
24. Friction Bridge: Build and use a friction bridge. See Figure 409.
25. The Observation Post: This makes a fun activity. In this event, a small campsite is set up with several obvious structures. The

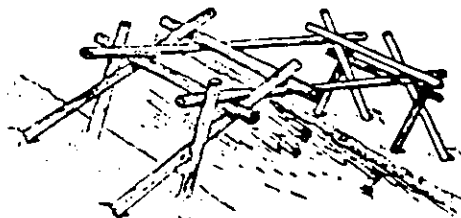

Figure 409 Friction Bridge

campsite is operated by one or two leaders, but the location of the campsite is unknown to the group. The object is for the group to leave their base camp and start out in the direction of the campsite, and without being seen by the leaders, they must observe and write down all of the structures they see and any other tell-tale thing about the camp. If individuals are spotted they must become prisoners of the campsite. If part of the group can get back to their base camp without being spotted and if they have most of the structures listed, the group wins the game.

26. Biscuit Baking: Bake biscuits in an improvised reflector oven.
27. The Bouillon Problem: This includes building a small fire, forming a cup out of aluminum foil and making a cup of piping hot bouillon broth.
28. Flood: The area will be flooded to a depth of four feet in five minutes time. With your group, find a suitable place and materials so that you can be dry, comfortable and warm for six hours. When secured above the flood line, you must make a boiled egg or a cup of soup to give you strength until the flood subsides.
29. Night Flight: Choose one of the group to be the leader. All are blindfolded except the leader. The group must follow a colorful course which has been laid out. Only the group leader can speak and he must lead and tell the group where to go and how to miss or negotiate the obstacles along the trail.
30. The Maze: This can be a 20 minute venture or a 3 hour event, depending on the length of the maze. A long piece of twine is laid out between point A and point B. Every few feet along that twine another long twine is tied into the first twine. Each of these twines have more twine tied on to it. When completed, you have a giant maze with many, many dead ends with only one trail leading to point B where the treasure may be found.
31. The Hanging Teeter Totter: Build a strong teeter totter, preferably with cable and doubled planking and have it hanging from a stout tree limb so that the horizontal planking is about 3 feet from the ground. Have the group balance on the teeter totter. See Figure 410.

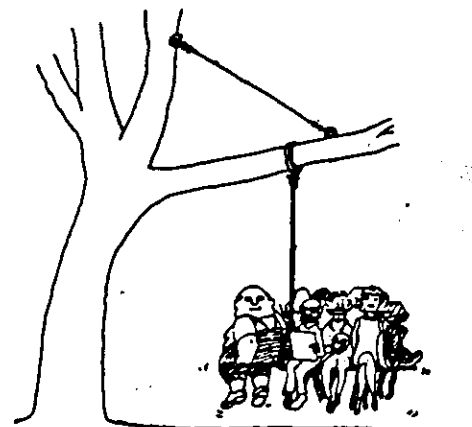

Figure 410 The Hanging Teeter Totter

32. The Tension Traverse: Secure a 30 foot cable or rope fairly tight between two trees about one foot off the ground. From one of the trees secure another rope about 20 feet up. This rope must be long enough so it will reach the other tree at the level of the first cable. Using only this rope as a balance, the object is to walk across the horizontal cable. See Figure 411. If this becomes too easy, use a diagonal rope from each tree and start one of the group from each side simultaneously. Passing each other makes this stunt a little more difficult.

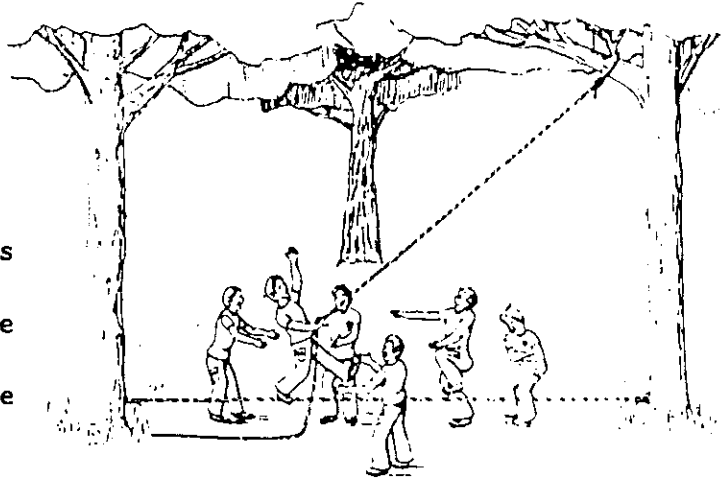

Figure 411 The Tension Traverse

33. The Floating Log: This challenge can be made in several different ways. One method is shown in Figure 412.

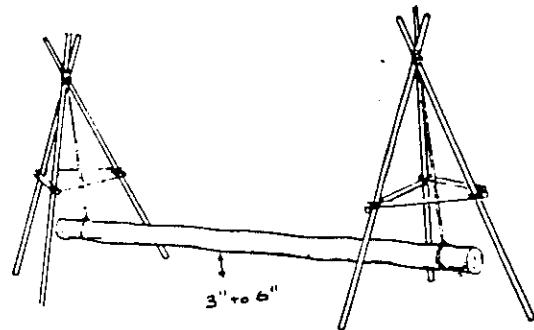

Figure 412 The Floating Log

34. Blind Polygon: The object of this group challenge is for the group to wear blindfolds to form a perfect square or triangle using a 100 foot piece of rope.

35. No Touch Beam: A 10 foot horizontal beam or pole is placed between two trees about four to five feet high. The object is to get the group over the beam without any of them touching the beam. The group may help each other.

36. The Porthole: A tire is secured between two trees as shown in Figure 413. The group tries to get each member through the tire. The members may help each other when they are in front of the tire. After they have gone through the tire, they can no longer help other members on the front side but may help them on the way out of the tire. The last member receives no help in getting up, but may be helped down.

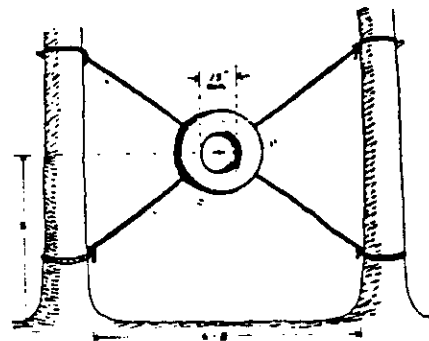

Figure 413 The Porthole

37. Build a Chippewa Table: See Figure 414.

38. Build a Revolving Derrick Bridge: This is shown in Figure 415.

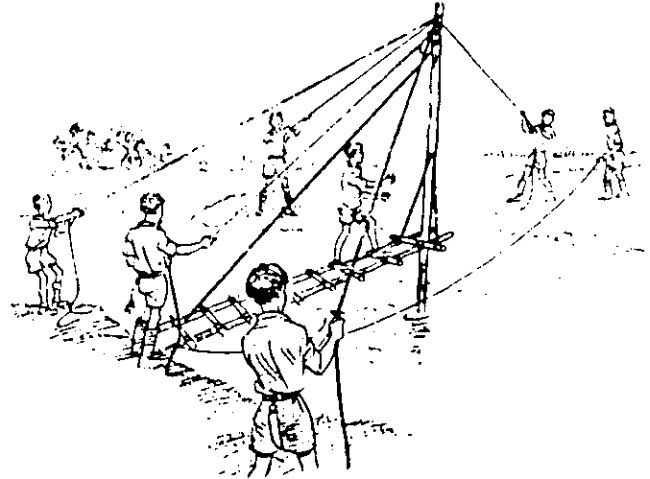
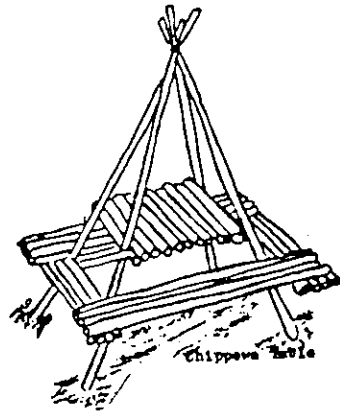

Figure 414 Chippewa Table Figure 415 Revolving Derrick Bridge

39. The Jiggler: In this exercise, two people attempt to make their way to the end of two diverging cables or ropes without falling off. The cable is from one to two feet above the ground and may be 25 to 40 feet long. One good method of setting it up is to use a long $\frac{3}{8}$ inch cable and encircle three well-spaced trees, such as in Figure 416. The two participants start out on the narrow end and work their way to the wider end. Leaning on one another is a good method of using teamwork.

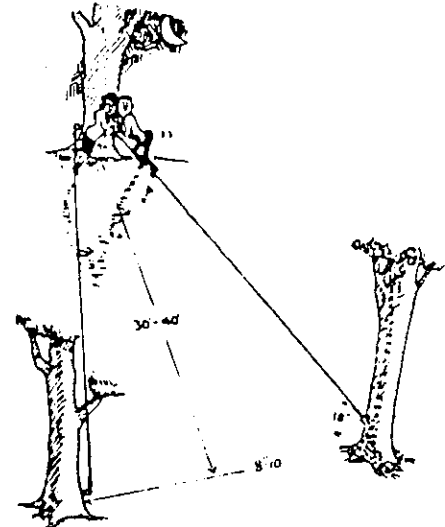

Figure 416 The Jiggler

40. Traffic Jam: This problem may be worked with 6 or 7 people. Six people line up in two teams on squares such as shown in Figure 417. Without any of the six talking, a seventh individual tells them how to move. In this exercise the six scouts must reverse

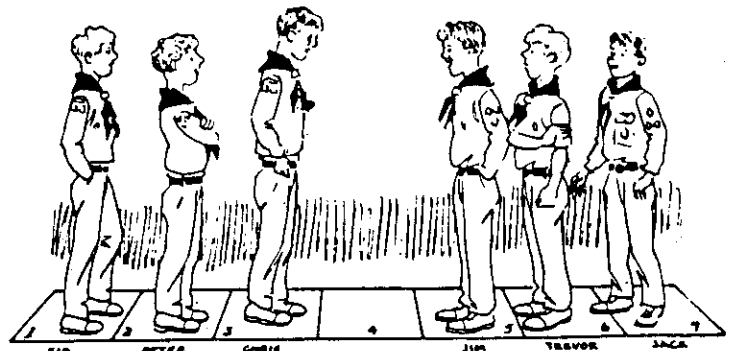

Figure 417 The Traffic Jam

their position so that Sid, Peter and Chris are in the squares occupied by Jim, Trevor and Jack, and vice versa. They can only move in the direction in which they are facing. They can move into an adjacent square, provided it is unoccupied and are allowed to by-pass an opposing player to reach a vacant square. No one can move backwards. Any move around someone facing the same way is an illegal move. Two persons cannot move at the same time.

After one has figured out the solution, have another try to solve the problem by exchanging places with #7.

By increasing the number of squares to nine, eight people may become involved with four facing each direction. The solution is the same.

In solving this problem one must avoid getting two members of the same team into adjoining squares until they are safely home. The solution in the figure is to move Chris from 3 to 4; Jim from 5 to 3; Trevor from 6 to 5; Chris from 4 to 6; Pete from 2 to 4; Sid from 1 to 2; Jim from 3 to 1; Trevor from 5 to 3; Jack from 7 to 5; Chris from 6 to 7; Pete from 4 to 6; Sid from 2 to 4; Trevor from 3 to 2; Jack from 5 to 3; and Sid from 4 to 5.

41. Moving Stepping Stones: This makes a good relay or timed event. This skill may be done by using circular hoops or another method would be to use a couple of small pieces of plank to stand on with an eye screw in each piece of plank to secure the rope. The rope then goes from the plank pieces to a solid bar and back to the walker. If desired, you could use a solid bar on each end of the 25 foot long course and run the rope in various combinations as shown in Figure 418. The object would be to cross the caustic acid field without touching the ground or getting your feet out of the loops. It goes without saying that you will need a little coordination to move hands and feet together.

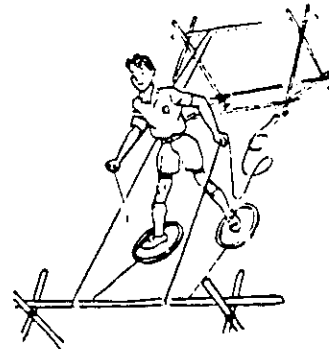

Figure 418 Moving Stepping Stones

42. The Kitten Crawl: Tie a taut rope around two trees about 25 to 30 feet apart. Have the rope about 3 to 4 feet above the ground. The object is for each member of the group to crawl along the two ropes from one end to the other as shown in Figure 419.

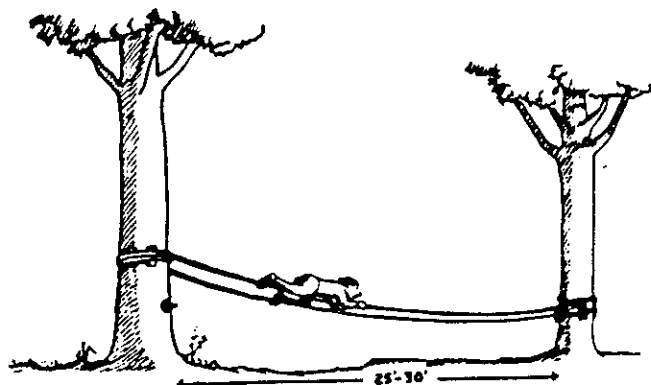

Figure 419 The Kitten Crawl

43. Nitroglycerine Transporter: The group is to construct a transporter for nitroglycerine and then move the nitro in the transporter in such a way that they won't detonate the nitro.

A tripod frame must be built with the legs of the tripod connected by another lashed frame. A No. 10 can is suspended in the center of the bottom frame, and a nut for a $\frac{1}{2}$ inch or larger bolt is suspended from the peak of the tripod so it hangs down inside the can without touching it.

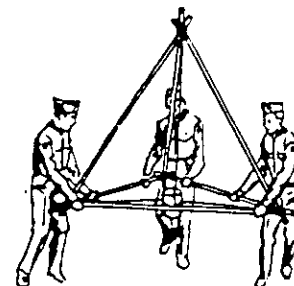

Figure 420 Nitroglycerine Transporter

The group should move the transporter over a prescribed distance. If the nut touches the side of the can at any time, the group must return to the starting line and carry it across the area again. See Figure 420.

44. The Sloppy Campsite: Let the group see and solve the questions of the mysterious campsite. They should identify the errors of "proper camping" in a pre-staged camp scene.
45. Reach for the Sky: How high can your group put a chalk mark on a wall without using any props? A body pyramid works well.
46. The Toboggan Walk: Make up groups of 5 to 8 people and arrange them in a seated toboggan fashion on the ground. Each person, except the first, should have their feet in the lap of the person in front of him so each person has only buttocks contact with the ground. Hands must be on the shoulders of the person in front of him. Only No. 1 person is allowed to touch the ground with his hands and feet. The object is to race against another group or against time in getting from Point A to Point B.
47. Mini-Safari: Study one square foot of ground. List all the plants and animals in it. Note factors such as sun, shade, temperature, moisture, etc.
48. Public Hearing: Hold a public hearing on whether or not to build a dam on a certain spot. Lobbyists can come to the meeting as a farmer, a fisherman, a trout, a salmon, a deer, a cottonwood tree, a water-strider, a mosquito and any others who would have an interest. Discuss the pros and cons.
49. Meet a Tree: Pair off. Blindfold one partner. The blindfolded person should explore a tree. The partner can make suggestions: rub your cheek on the bark, is your tree alive?, are there plants growing on it?, can you put your arms around it?. When the person "knows" the tree, he/she is lead back to the starting point. Take off the blindfold and have the person find the tree.

50. Creek Scanning: How much life can you see in the creek? With a creek scope you can see a lot more. To make a creek scope, cut both ends out of a large tin can. Stretch cellophane over one end with a rubber band. Place the cellophane end in the water and look into the can at the creek.
51. Insect Screen: Tie a white sheet between two trees at night. Shine a flashlight onto it and see what is attracted to the light. Move the light and see what happens. Use the sheet as a screen. Who can you recognize by their silhouettes?
52. Gold Rush: Rocks are painted gold and hidden beforehand. See who can find the most gold.
53. Un-Nature Trail: Place manmade objects along the trail. The group tries to spot (but not pick up) as many as they can. Some objects should stand out and others blend in. This activity can lead to a discussion on camouflaged animals.
54. Fairy Night Hike: As a surprise, get the group up in the night. Take them on a hike to find "faries." (Bags of candy tied to trees).
55. Pop Corn Trail: Lay a trail using pop corn. This is a good exercise in trailing.
56. Craft Hike: The trail has several stations in which a camp craft must be performed before the group may proceed. Stations include: fire building, knot tying, lashing, map reading, etc.
57. Survival Hike: Pretend you are stranded. Build a shelter from natural materials. Find water, build a fire without matches, signal searchers, etc.
58. Astronomy Hike: Hike at night to a spot where the group will star gaze.
59. Incher Hike: Collect as many things as possible that are one inch tall, round, long, wide, etc. Measure the treasures upon returning and see who noticed the most tiny things that are usually overlooked.
60. Beauty: What is the most beautiful thing you can find in nature? What makes it beautiful? How can you share your feeling with others?
61. Indian Method of Recording History: Use a large piece of paper. Start at the center and draw pictures showing activities of the day. Continue in a spiral fashion outward to include the entire session.

62. All Aboard: The object is to see how many people you can get onto a two foot square piece of 3/4 inch plywood which has been elevated 3 to 4 inches off the ground.

63. The Trolley: The object is to move a group of eight (variable) people over a poisoned yogurt area utilizing two 4" x 4" x 10' planks which have 16 three foot chain-festooned lengths spaced on the 4 x 4 as shown in Figure 421.



Figure 421 The Trolley

64. The Deducting Detective: Make a tracking space about eight feet square in damp sand or dirt. Rake the tracking pit and stage a simple problem. Have the group deduct what has happened. Sample: One man carries another, puts him down on the ground, sits down to rest himself, lights a cigarette, picks up the man again and carries him out.

Many tell-tale things may be used in a tracking pit, such as cigar wrapping, book of empty matches with hotel advertising, high heels, rifle butt, man with a cane, walking backwards, or a man with a limp.

Play the FBI game and have one of the group walk across the tracking area when the others in the group are unaware of it. When the group all come to the tracking area they are told that the FBI is hunting a criminal, they have found his tracks, and they are asking the group's help to find the criminal. Shoes, decide who is the "criminal."

65. The Artists: In this activity a group is given a few artists supplies. Maybe all that is needed is a paper and pencil to make a sketch. The picture or subject that the group is to sketch is not before them. The only way the picture can be sketched is to appoint two members of the group to go with a referee, look at and study the object or picture to be sketched. The observers can take no written notes with them back to the group. When the two observers get back, they must tell the remainder of the group what to draw. The observers are not allowed to do the drawing. In the allotted time, can your group sketch the object or picture the observers tell you about?

66. Sun and Glass: Given magnifying glasses and a punk, such as lamp wicking, can your group start a fire by coning the sun's rays? Usually a two inch or larger magnifying glass works better than a smaller one. The sun must be high in the sky with little or no wind. Patience is the key!

67. Hippopotabugs: Our area has been invaded by several hippopotabugs (which look exactly like inflated balloons). Any one of these creatures could wipe out the entire population of our state. They cannot be touched by anything except wood. Touching one of the bugs would result in a horrible agonizing death. The government has put a bounty on every hippopotabug captured alive for research but they can only be caught between the hours of 10 and 11 p.m. (variable) while they land on the ground to sleep. If these bugs are handled roughly or improperly they will instantly self-destruct and die by deflation. They were last sighted in the vicinity of the flag pole. Your group must capture alive as many hippopotabugs as possible and turn them over to the government's agent.
68. Natural Pigmentation: With natural pigments only (using leaves, flowers, nuts, moss, lichen, pollen, petal juice, squashed flies, blood, ashes, etc.) each group must paint a recognizable picture. This picture must be framed and set up in an art show if other groups are doing the same event.
69. Ice Melt: Give each group an ice cube and a 20 to 30 minutes project. The object is to get the project done before the ice melts. The ice may be wrapped in mud, paper or cloth etc. before starting the project.
70. Mine Field: Mark off a small plot in the sand which represents a mine field. Before the activity is started, several small blown-up balloons must be buried just under the surface of the sand so they cannot be seen. The object is to get all members across the mine field without an explosion.
71. Spot the Spot: In this exercise the group tries to find a certain spot on the ground where a bomb, directions, play money, treasure, etc. is buried. The only clue you have for finding the spot is a list of things you can and cannot see. One list is entitled, "From this spot I can see." Here you must list eight obvious things you can see when standing on the spot. Another list is entitled, "From this spot I cannot see." Here you must list eight obvious things that you cannot see. However, on this list there must be at least two obvious things listed which you cannot see because they are hidden by something else because of your position on the particular spot. For example, you may not be able to see a certain upright pole because it is behind a particular tree, or you may not be able to see the door on a certain building because of a power pole. The two things you cannot see should be at least 90° or more apart. A contrived story made up to go along with this problem helps to make a reason for having to find the spot.
72. Step-Slide: Secure a 35 foot taut rope or cable between two trees about ten feet above the ground. This also works especially well

over a small creek. Make two two-loop slings so they are between four and seven feet long. These may be just a piece of 3/8 inch manila rope with a bowline tied in each end. On one set of the bowline loops put a snaplink or chain "quick link" snaps. These two loops will be snapped into the horizontal traverse rope. The two loops hanging down will be big enough to accept the individual's feet. With the feet in the two loops and your hands on the snaplinks, you can shift your weight from foot to foot and propel yourself across the traverse line. See Page 138.

73. Spin, Bait and Fly Casting: Show and demonstrate equipment, technics of use, safety factors, etc. Use such things as bicycle tires and hula hoops as targets.

74. The Balance Beams: The object is to transport a group over a 25 foot surface of flat ground which has been smeared with poisonous radiating grape jelly. Your feet must be at least eight inches above the ground in order to escape the radiation poisoning.

The only things available to get the group across are five empty No. 10 cans and four 2 x 4's six feet long. If the ground is touched by hands or feet the participant must try again.

75. Booby Trapped: Improvised booby traps are shown in Chapter 13. They can be made very easily and with a short printed story to go with the booby trapped box the group can have a lot of fun.

"This box represents a booby trapped bomb, which you can see by the timer, is designed to go off in three minutes. Your mission, should you decide to accept the assignment, is to disarm the bomb by disconnecting the "lead" from the power source. No tools or other equipment is necessary. The sound of a bell or horn signifies that you have made an error and the detonator has been released and the whole kit and caboodle will blow everything to heaven.

Good luck and take care."

At the end of the last chapter we left a space for other considerations. In this chapter on group challenges, we will also leave a page for your own thoughts or new activities as they occur. One of the best ways to have good programs is to have a wealth of diversified activities and ideas.

- 76. _____
- 77. _____
- 78. _____
- 79. _____
- 80. _____
- 81. _____
- 82. _____
- 83. _____
- 84. _____
- 85. _____
- 86. _____
- 87. _____
- 88. _____
- 89. _____
- 90. _____
- 91. _____
- 92. _____
- 93. _____
- 94. _____
- 95. _____
- 96. _____
- 97. _____
- 98. _____
- 99. _____
- 100. _____

CHAPTER 16

HYPOTHETICAL PROBLEMS

A hypothetical problem is a tentative assumption made in order to draw out and test its logical consequences.

Chapter 14 covered 135 ideas that a group might try for demonstrations or learning experiences. Chapter 15 listed 75 fun things that a group might try as a group challenge. Chapter 16 will cover 50 fun problems.

These problem activities are designed to test a group's ingenuity, skill and leadership. The problems or obstacles are best set up by someone other than the group doing the activity and a time limit should be set for each activity. If physical features, material and supplies are ready, each problem listed here should take between 10 and 30 minutes.

For each problem a card should be prepared as in Figure 422, stating the situation, what each group must do and how much time they have to complete the problem. One solution will be given for each problem, but there may be many different solutions.

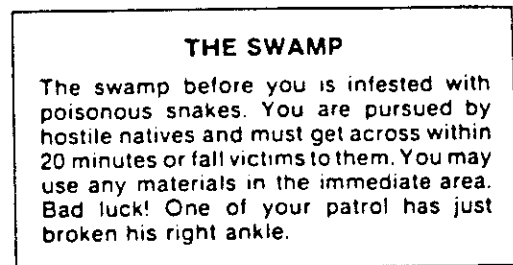

Figure 422 Typical Problem Card

The staff personnel in charge of the problem should know the problem well and what must be done to succeed. He must play the game with utmost enthusiasm. After he has handed the problem to the group leader, he should only answer questions that have a clear, decisive relevance to the matter at hand. If a problem states that a twine represents the edge of a cliff, canal or chasm, the group should lose points for stepping over the twine. If a twine or rope represents an infested waterway or an electrified fence, the group should again lose points for stepping over the twine or touching the rope. If the staff person makes it serious fun, the group will follow. If the staff person thinks the problem silly, stupid, or absurd the group, too, will think it is childish, and as a result the fun will be lost. Therefore, if you want this type of a problem to work well, it must be done with eagerness, optimism and with a spirit conducive to the problem. Always remember to try and make your problems look as realistic as possible.

When the leader of the group is given a copy of the problem, he should read it to the group, they should discuss how to accomplish the mission and then proceed.

If desired, sometime after the completion of the problems, the group may make their own evaluation as to style of leadership, planning and performances.

Problem 1 The Radioactive Isotope

You and your group represent members of a demolition team. You have been called into this area because somehow a radioactive isotope has been left standing in this area. Closer inspection of the isotope revealed that the detonator cap has been released and any rough handling of the isotope or if the isotope is allowed to fall over it will probably explode. Besides this, the isotope has slowly flooded the area with a deadly hovering gas which prevents you from getting closer than the twined off area. Gas masks do not repel the gas. After the isotope is disarmed, the poisonous gas will fade away. The only way that the isotope can be disarmed is by placing it into the can of kodo solution which stands at the edge of the roped off area. The timing mechanism will set off the isotope in 15 minutes if it remains where it is. If it explodes, the entire area for miles around will become radioactive. You must do your duty and disarm the isotope. The only material that you have to work with lies before you. Start your plan of action.

The "hot" isotope is in the center of a twined off circle, which is from 35 to 50 feet in diameter, as seen in Figure 423. The isotope cannot be touched, nor can any member step into the radioactive circle. The isotope could be a 3 to 5 inch mailing tube, a piece of old stove pipe or tin cans soldered together and painted. It should be approximately 16 inches high. If possible, put a battery in the can with a buzzer that is turned on and off by a mercury "position" switch. Then, if the isotope falls over, the buzzer will sound.

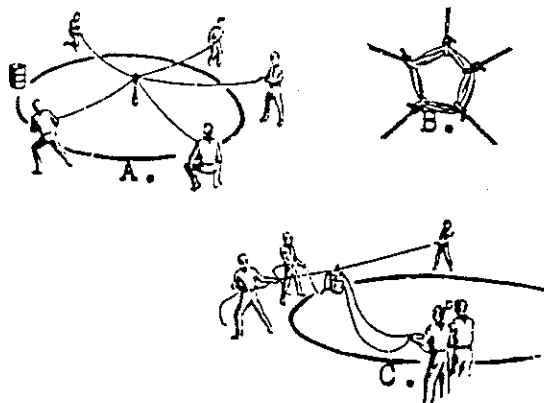

Figure 423 The Radioactive Isotope

The materials needed for this problem include the twined off circle, the isotope, a can labeled "Kodo" that the isotope will slip into, five to seven ropes each about 25 feet long, and about six No. 63 rubber bands which are about 3 inches by $\frac{1}{2}$ inch.

The solution to the problem is shown in Figure 423. Each of the ropes are tied to the elastic rubber bands, which when expanded will slip over the top end of the isotope, and when the rubber bands are at rest around the isotope they will hold the isotope snugly. See Figure 423-B. Then the isotope may be carried off and put into the can of kodo solution as in Figure 423-C.

Problem 2 The Piranha Pool

You are "Soldiers of Fortune" exploring for gold in the jungles of Peru, close to the headwaters of the Amazon River. You are being chased by a band of Jivaro Head Hunters, and they have forced you into a long narrow canyon with 100 foot high walls on either side of the path. They have set a trap near the end of the canyon. The trap consists of a flat bottomed pool that is the width of the canyon walls and 15 feet long. The pool is only six inches deep, but it is filled with deadly piranha fish. To try to run through it would mean certain death. All that you have with you are two No. 10 cans of tomato juice, a can opener and a 15 foot clothesline rope.....The Jivaro Head Hunters are 15 minutes behind you. If you could get across the pool, your escape is waiting.....Can you save all of your party?

This problem will work best on a concrete slab, a wooden floor or hard level ground. The materials needed are two No. 10 empty cans representing the tomato juice, a triangular punch-type can opener and a 15 foot rope which may be cut in half, and then you must have a marked off area for the pool.

The solution is to cut the rope in half, punch two holes opposite each other on the bottom side of each can, slip one rope through each hole of each of the cans and then tie the rope ends together, thus making a pair of improvised stilts. Each person can then walk carefully through the water and toss the stilts back to the next person. Walk carefully so as not to cave in the side of a can.

Instead of using the above material, a variation to this problem could be to use two 8 foot 2 x 2's, a saw and a couple of 12 foot lashing ropes. A couple of 6 inch pieces could be cut off the end of each 2 x 2 and they could lash the short 2 x 2's to the long ones and make a regular pair of stilts. Throwing in extra material, such as a bow, arrow and string, sometimes will throw a group off the track for a while and makes the problem more interesting. It may also be a good idea to include a strong piece of cord to attach to each stilt in the event a member falls in the middle of the pool and is eaten up by the piranhas. This way you can retrieve the stilts.

Problem 3 Radiation Release

When your group entered this area, you triggered off a time device which will set off an alarm in 30 minutes. This alarm will instantly flood the area with a lethal radiation to a height of 2½ feet in the diameter of the circle. You cannot leave the area within the time limit. Before the alarm goes off, you must get all of your members at least 2½ feet above the ground. After they are above the ground, you must start a fire with the material you have been given. After the fire is started, you must prepare toast to give you strength to go on while the radiation subsides. The only equipment that you may use lies within the circle. Using your pioneering ingenuity, can you save the patrol?

Material for this problem includes a circle of twine about 12 feet in diameter, three sturdy 7 foot fence posts or 4 x 4's, three good 2 x 2's about 3½ feet long, seven pieces of clothesline rope 18 feet long, a No. 10 can filled with newspaper, sticks and a flint and steel set for starting fire. (Flint and steel sets may be obtained from any Boy Scout Distributor.) Then you will need a small piece of mesh or grill wire to go across the top opening of the can and a slice of bread for toast. A pair of gloves and a yardstick may be useful.

The solution to this problem is to make a large tripod with the posts and one rope. Between 2½ and 3 feet above the ground, you lash one of the 2 x 2's horizontally across each side of the tripod with the remaining six ropes. Then your group climbs up on the 2 x 2's and takes with them the can, paper, kindling, the flint and steel sets which include tinder, and of course, the slice of bread and the gloves to handle the hot can in the event you can make a fire in the can with flint and steel. The mesh makes a usable toaster.

Problem 4 Plutonium Search

Hi Men!

In the marked off area before you there is a reported small area which is believed to be the focal point of a Plutonium Deposit. The multi-million dollar Plutonium Detector lies before you. Because of the exposure factor, you can only work on this project for ten minutes. If you find the plutonium focal point, a ticking sound will be heard. If you encounter this sound, each of your patrol members will receive \$50,000.00 from the higher echelon.....Good sounding, Men.....

You will need a twined off area about 12 feet by 12 feet in an area of sand or loose sandy soil. Somewhere in the area a loud ticking alarm clock is buried in a can just below the top soil. The can makes the ticking of the clock louder. The Plutonium Detector is an improvised apparatus made of a garbage can cover with a long handle on it as shown in Figure 424. A hole is drilled through the cover at any convenient point and an ordinary garden hose Siamese fitting is welded around the hole. Two short hoses from the fitting on the cover to the ears make an improvised stethoscope. One person sweeps the ground while another listens for the ticking. The only other materials needed besides the Plutonium Detector and the buried clock is a \$50,000.00 bill for each member of the group in the event they find the focal point.

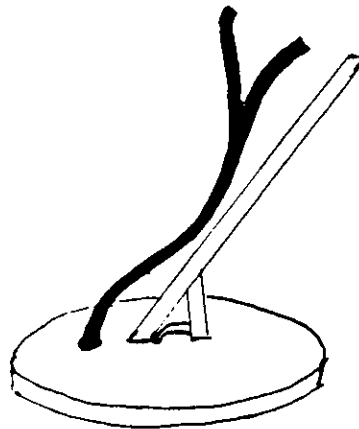

Figure 424 The Plutonium Detector

Problem 5 The Pit

Your party represents an African Safari of old overweight scientists. You have been captured by a Zulu tribe and they intend to have you for dinner, so they have placed you in this hole while they start boiling the water. The hole is represented by the chalked off area and each side of the hole has the same height as the concrete wall on the west side of the chalked area.....On top of the hole, near the pit is a large tree limb (represented by the fence). You notice a small reachable hank of doubled raton (rope) hanging over the limb into the hole.....Unknown to the Zulus, you have managed to smuggle two ropes into the hole. Looking around inside of the hole, you notice several sticks. If you could get out of the hole, your jeep is waiting and there is an excellent chance that you could make a clean get-away.....Are you able to do it??? You have about 15 minutes.....Good luck, Men.....

For this problem you need an 8 to 10 foot hole or some sort of a wall which you can climb up and onto the top of it. Being in an empty swimming pool works well. Usually a swimming pool has a fence around it which is strong enough to hold your weight and the deepest part of the pool makes a usable wall.

The materials you need besides the piece of double rope hanging just in reach, are several 18 inch 2 x 2's laying in the "pit" and two pieces of 3/8 inch rope about 15 feet long.

The solution to the problem is to first adjust the piece of "raton" rope hanging into the pit so that you can tie one end of each of the 15 foot pieces of rope to each end of the simulated raton. Not too far down from the bight of the rope you should tie a couple of loop knots (page 84) for hand holds. Then, starting as high as you can reach, you should start making a marline spike hitch ladder and work downward with the 2 x 2 pieces. Then you can climb up the ladder and when you are high enough you can use the overhand loops as hand holds and get the old overweight scientists to freedom. We must assume that the scientists are too heavy to climb the rope hand over hand.

Problem 6 The Mad Bomber

Your group represents members of a police bomb squad. You have been tipped off by the "Mad Bomber" that he has planted another bomb in this area which will go off in ten minutes. As in the past, the "Mad Bomber" wants to play "Cat and Mouse" so somehow he has secretly left the following note on the Chief's desk.....

On a magnetic azimuth of ___ degrees.
From a red and brown post, if you please....
Go 132 feet down the slope.
Pick up a rock and there's a note.
Hurry on now, time is running fast.
Catch the Mad Bomber at long long last!

At the start of the problem, the group leader is given the paper with the above problem, using a magnetic compass azimuth of your choice. Close by is a brown and red stake with a compass on it. On the magnetic azimuth of your choice, the group paces off the 132 feet, and under a thumb-sized stone is a small six inch long piece of pipe pounded into the ground so that the top of the pipe is at ground level. Several larger rocks should be thrown around the area as decoys. Inside of the pipe is a 3 x 5 inch card with this message:

You are smarter than lard
To find this card.
So now we make a little more joy.
Proceed to the table to find a toy.

On a table which is close by is an improvised booby trap consisting of a battery, bell and a mercury "position" switch. This can just be a simple wooden box with a top lid or door that opens on hinges. When the lid is shut the mercury switch, which is attached to the underside of the door, is open so no current flows through to make the bell ring. When the lid goes open to a vertical position, the mercury in the switch closes the gap and the current flows making the bell ring, which simulates the release of the detonator. Therefore, between the horizontal position of the lid and the vertical position, one must carefully reach in and disconnect the lead wire from the battery. Naturally, booby traps can be made as elaborate as one wishes. The note or placard at the booby trap should read something like this:

This box represents a booby trapped bomb, which you can see by the timer is designed to go off in 3 minutes. Your mission is to disarm the bomb by disconnecting the "lead" wire from the power source. No tools or special apparatus is required. The sound of a bell signifies that you have released the detonator cap and the whole kit and caboodle will blow us and everything else sky high. Any rough handling of the box may release the detonator cap so do not throw the bomb in water.

Problem 7 Prison Camp Rescue

You and your group are prisoners in a Chinese Prison Camp. However, rescuers are on the way and the Underground has gotten word to you that they are about ready to attempt a rescue. In order to do this, the rescuers want you to signal them by placing a pail over the flagpole top when the guards are out of the area. The time is NOW....You must figure out a way to signal your rescuers by placing the pail over the top of the flagpole. The only material that you have lies before you. You have 10 minutes to signal your rescuers in order to save your party.....Good luck!!!

The material needed here is, of course, a flagpole with a good halyard. You will also need a five gallon "pickle" pail, a six foot long closet pole and one small rope or twine about six feet long which may be cut in half if desired.

The solution to this problem is to tie the bottom end of the 6 foot staff to the "up" halyard. Then about three quarters of the way up the pole, either the "up" halyard is hitched to the pole or the small rope may be cut in half and the second half can be tied to the "up" halyard. The pail is then put over the top of the pole and hoisted. When the top knot on the pole reaches the top pulley, the top of the pole with the pail over it should be well above the flagpole top. With a little jiggling, the pail will settle down over the top of the flagpole and the pole may be withdrawn. Get the pail off the flagpole in the same manner it was put on. Keep your eyes on the pail so it doesn't fall off the staff and hit someone on the head.

Problem 8 Reaching for the Word

You and your party are on one side of a high walled canal. On the opposite side of the canal, represented by the twined off area, is a can with a written message in it. You cannot get into the canal because it is infested with poisonous water snakes and besides it would be too difficult to get down and up the vertical walls. The canal has no bridges and it is too far to walk around. You have obtained word that there is a vast treasure which will be presented to the group who can get the message and decipher the code. The only material that you have to help you lies before you. Can you get the message and have it decoded in 15 minutes?

For this problem you will need a twined off area 15 feet wide to represent the canal, plus a No. 10 can with a message in it on the edge of the far side of the canal. You will also need five 3/4 inch dowels about 4 feet long and eight small lashing ropes less than 1/4 inch in diameter and about 5 to 6 feet long.

The solution to the problem is to round lash the five dowels together, overlapping each dowel about one foot. This makes a 15 foot long pole with which you can carefully pull the can over and ride it back on the end of the pole. The coded message in the can may be deciphered to tell the group where to look for the treasure - possibly an all-day candy sucker for each member of the group.

Problem 9 Determine Your Position

Drive a small inconspicuous peg into the ground so that the top of the peg is even with the ground. The peg should be about the diameter of a silver dollar. From the peg, take an accurate compass bearing on three different objects that are at least 90° apart. Now, starting at least 25 feet away from the peg have the group find the peg by lining up the three bearings.

The material needed for this problem is a compass with accurate degree readings to the three objects.

The solution is to find the stake by taking correct compass readings on the three objects.

Problem 10 Radioactive Waste

Your group represents a demolition crew that has been called into this area. It seems that a heavy drum of radioactive waste material has fallen onto a bag in the middle of a patch of quicksand, which is represented by the twined off area. As a result, you cannot enter the circle. It is estimated that it will sink into the bag and quicksand in 15 minutes. You have no time to get more equipment other than the material that lies before you. Can your group retrieve the drum in 15 minutes?

The twined off circle should be about 45 feet in diameter. You will need a five gallon bucket with a handle, and the bucket should be filled with heavy rocks and set in the middle of the circle. This represents the drum of waste. You will also need four 10 to 12 foot 2 x 2's and two 12 foot $\frac{1}{2}$ inch lashing ropes. Then you will need a 100 foot rope, a 25 foot rope and a fairly heavy hook of some sort.

The solution to this problem is seen in Figure 425. It takes at least seven people to do the problem. Start by attaching the middle of the 100 foot rope to the hook and the 25 foot rope to the rope just above the hook as in Figure 425-A. Then make two bipods (shear legs) and center the 100 foot rope over the top of the bipod lashing as shown in Figure 425-B. It will take four people to hold the two bipods upright. One person will have to be on each end of the rope that goes over the bipod and one person will have to manipulate the short horizontal rope that goes to the drum. The three people on the ropes will have to jiggle the hook into position so that it catches the handle of the drum. Then if all members of the group work together the drum can be raised and pulled out of the circle as in Figure 425-C.

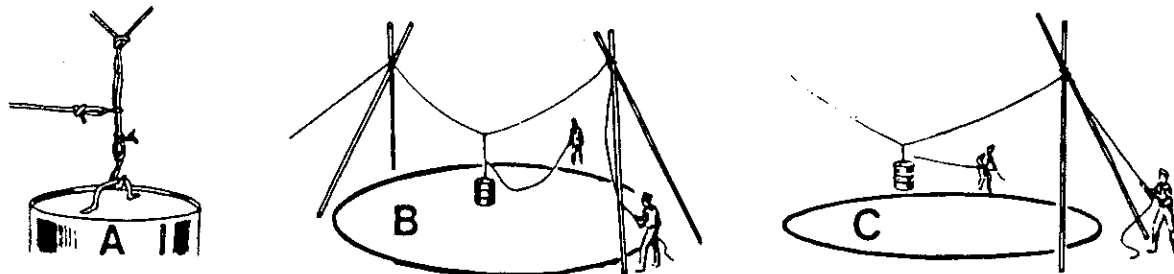

Figure 425 Radioactive Waste

Problem 11 Commando Flight

Your group represents a patrol of British Commandos who are returning from behind enemy lines where you destroyed a major center of enemy operation. In retreating to your own lines you had to deviate from your planned course. You are now by this tree and you are confronted with a river which is marked off by the twined area. Getting across the river means your safety. There are no boats and no rafts and the river is much too deep to wade across. To deviate from this area would mean contact with enemy patrols and there are no methods of signalling. Only one man can swim well enough to get across the river, and he is not good enough to help

others across. The only material that you can use lies before you. In 20 minutes it will be daylight and you will be spotted by enemy patrols. Using your pioneering ingenuity, can you get your patrol across the river to safety??

In this particular problem you must select an area where there are two deciduous trees approximately 35 to 50 feet apart from each other. The simulated river runs between the two trees with one tree on each bank of the river. The sides of the river should be about four feet from each tree. The only material needed is a 75 to 100 foot $\frac{1}{2}$ inch rope or larger.

The solution is to have the one person, who represents the swimmer, walk across to the far tree with one end of the rope. He then secures the rope to the tree with a round turn and two half hitches. The rope is then tightened, with a tightening arrangement if needed, and then secured to the other tree. The British or American Crawl is used to cross the one rope bridge.

Problem 12 The Pole Climb

Your group is in a concentration camp. Tomorrow you have been doomed to die. You have one chance to escape. A fifty foot pole stretches to a window high above the ground. If you could get up to this window, you could be led to safety by the underground. At the present time the guards are all at a party and the pole is in an inconspicuous place. You have managed to find two pieces of $\frac{3}{8}$ inch rope, each one about 12 to 15 feet long. Can you save your group before the guards make their next check in 20 minutes?

In this problem we will use only a 12 to 15 foot piece of $2\frac{1}{2}$ inch diameter pipe, which is set vertically on the ground. Near the top of the pipe is a platform or tree branch etc. representing the window. The only other materials we need are the two pieces of $\frac{1}{4}$ inch or $\frac{3}{8}$ inch rope that are about 15 feet long. The only other thing we may need is a ladder to climb down after we climb the pipe.

The solution to the problem is to use the Prusik Climb.

Problem 13 The Grappling Stick

You and your group are members of an archeological search team who have found a very heavy pail of gold coins. Twenty minutes behind you is a band of robbers who are pursuing you to steal the gold. In front of you is a very deep chasm, represented by the twined off area. If you could get the heavy container of gold coins onto the other side of the chasm, you could save the gold. You dare not take the chance of throwing the gold over, but you can utilize the tree or frame on the other side if you wish. If you can get the pail across the chasm, your companions will pick up the prize and keep it for you. Can you get the pail of coins over the chasm in 15 minutes with the material in front of you as your only help?

In this problem you should make the width of the chasm about 12 to 15 feet wide. On the far side of the chasm there should be a tree with a heavy branch so that a rope with a loop could be thrown over the branch without any problem. Perhaps the branch or tree would have to be trimmed. You could also use a fixed horizontal pole which would be about five feet off the ground.

The materials needed for this problem would be a suitable tree and the twined off chasm. You also need a 40 foot $\frac{1}{2}$ inch rope, a heavy cord or sisal line, a grappling stick and a spreader stick to hold the loop in the $\frac{1}{2}$ inch rope open. You will also need a heavy enough pail that it cannot be thrown across the chasm. Perhaps you could use a five gallon pail filled with stones. You should also have a short piece of rope to tie the handle of the pail to the $\frac{1}{2}$ inch rope.

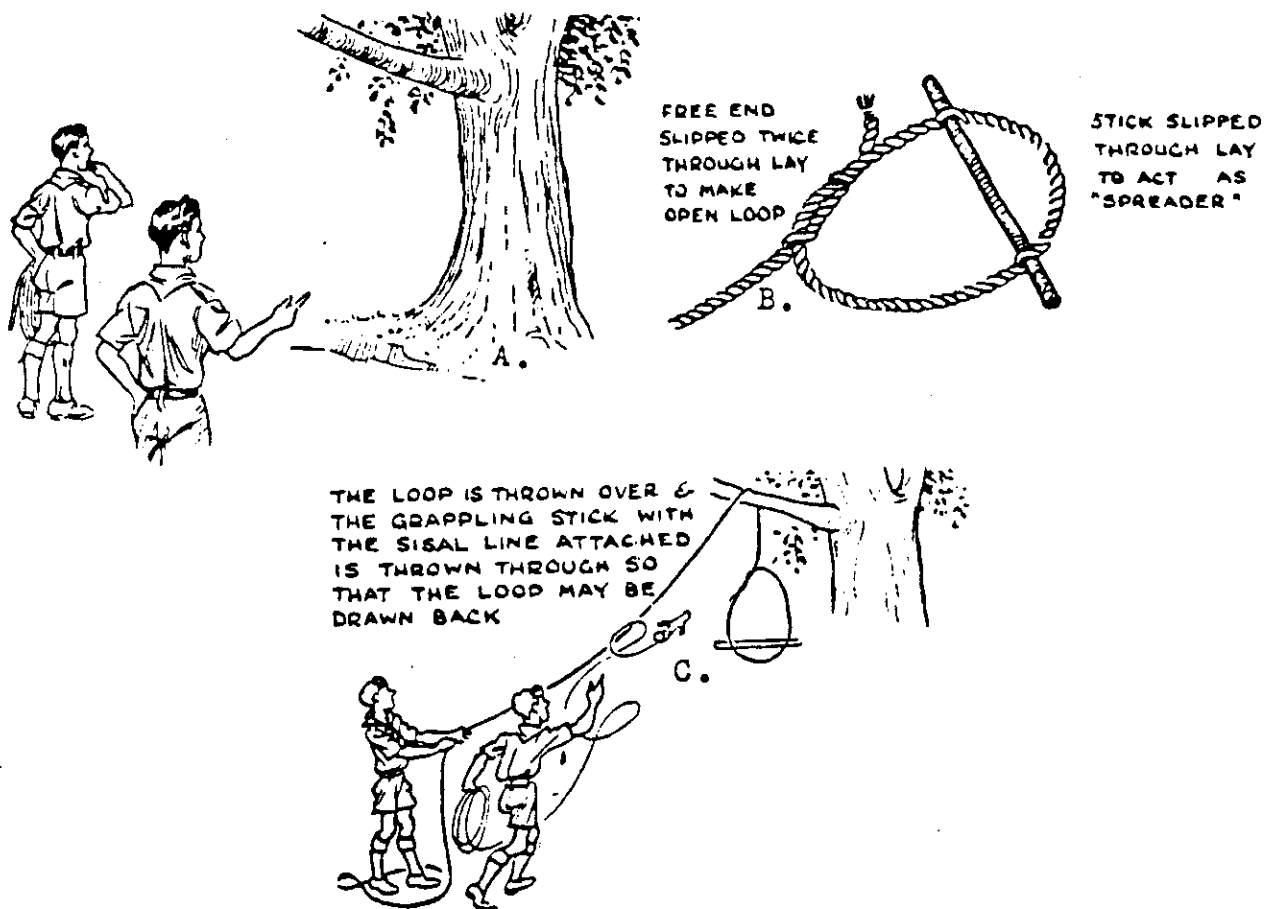

Figure 426 The Grappling Stick

The solution to this problem is shown in Figure 426. After the proper tree is found as shown in Figure 426-A, your next step is to make a loop in the end of the $\frac{1}{2}$ inch rope, using the spreader stick to keep the loop open as in Figure 426-B. The rope is then coiled into the left hand and the loop end of the rope is thrown over the branch. The cord or sisal line is then attached to the grappling stick as in Figure 426-C. The grappling stick is then thrown through the loop so as to have the grappling stick barbs catch the loop or spreader stick. The rope is then

pulled back and the loop end is attached to the other end so that you have a continuous rope from around the branch back to your side of the chasm. The pail of coins is then tied to the rope and conveyed across the chasm. The rope is then thrown into the chasm so the robbers can't get the coins back. Take care to hang on to the ends of the throwing lines so that they are not lost in the chasm.

Problem 14 Peter's Dilemma

Peter has gotten marooned 40 feet up on the inside of a window ledge in the ruins of an old mill. The only thing that Peter has access to is an old rusty piece of water pipe that is about six feet long. Bob, his gallant partner on the ground, has a 30 foot manila rope 1 inch in diameter, which is much too heavy to throw up and besides, it is too short to go the distance. In any case, there is nothing around the window to tie a rope to. Peter's only way of escape is down the outside wall. How can Peter get down without getting more help? See Figure 427.

This makes a good discussion problem, but in order to put it into practical application we would probably have to tone the problem down a little by using a lower "window ledge" and a smaller rope. We could put the simulated window at 20 feet and use a 15 foot $\frac{1}{2}$ inch manila rope instead of the one inch rope. However, it should be kept in mind that you are theoretically working with a 40 foot height and a 30 foot one inch manila rope.

The solution would be for Bob to unlay one strand from the total length of the rope, and from it would unlay two of the constituent strands, which when joined together would make a light throwing line of approximately 58 feet. The end of the light line would be weighted and thrown up to Peter who would hank up the other $\frac{2}{3}$ of the rope. Peter would then put the two small 30 foot strands together and double them. This would make two lengths of rope that would total 45 feet, which when tied together with a double sheet bend would make a total length of - say - 43 feet. He then ties the larger end of the rope around the middle of the six foot piece of pipe, throws the other end of the rope to the ground, secures the pipe to the inside of the window frame and descends the rope using the foot-lock.

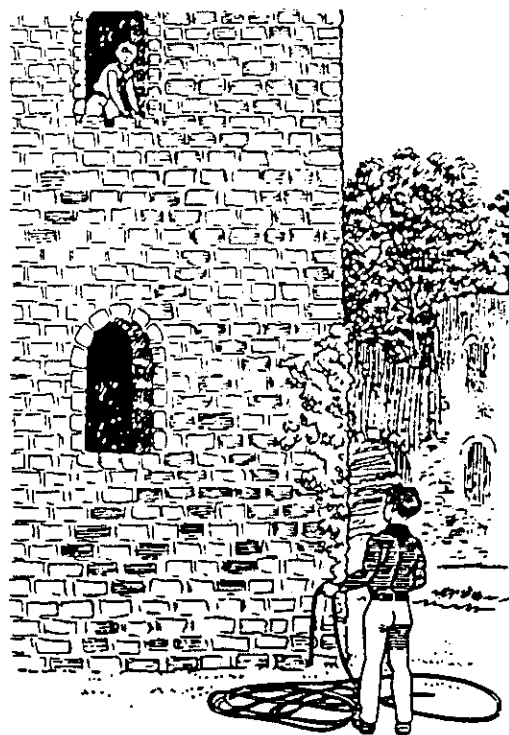

Figure 427 Peter's Dilemma

Problem 15 The Kickbridge

Your group and another team decided to have a race to a certain old building which is close to an industrial area. Your group has come to a drainage ditch which is several miles long. To walk around the ditch would take a couple of hours and probably lose you the race. The members in your group do not want to get into the ditch of waste and sewage, so you have decided to build a kickbridge, as shown in Figure 428, to get your group across. If the other team is doing the same thing, can you beat them without having anyone get their feet into the sewage ditch? The only material that you can use lies before you.

This is a method a group may use to cross a stream or ditch in which no group member has to get wet. First, attach a horizontal "boom" pole to a vertical pole, then attach guy ropes to the top of the vertical pole and also attach one rope to the end of the boom pole. Second, put the base of the kickbridge into the middle of the stream while the rest of the group members hold the guy ropes so the vertical pole will be upright and slanting toward the opposite bank. The first person to cross now takes his guy rope, walks on the horizontal pole to the vertical pole and holding on to the vertical pole kicks the boom pole around to the opposite bank. The second person to cross must hold the boom line so he can get the boom back. After three or four have crossed in this manner, the vertical pole is slanted the other way and the remainder of the group cross over in the same manner.

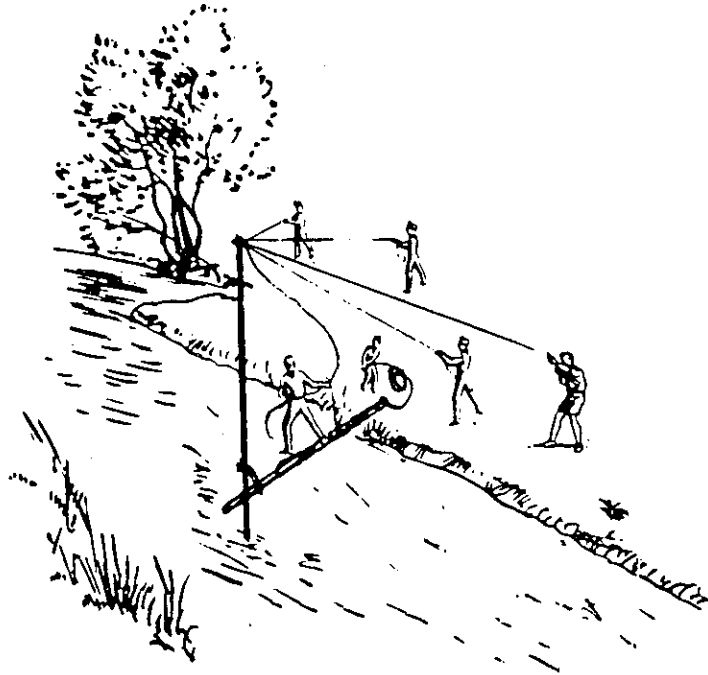

Figure 428 The Kickbridge

The materials needed for this problem consists of a twined off area that is perhaps 15 to 18 feet wide and a stout vertical pole between 8 and 10 feet long. Then you will need a light strong boom pole that is a couple of feet longer than half the width of the area to be crossed. The boom is attached to the upright so that it extends past the vertical upright 8 to 10 inches. It is attached with a loose lashing so one can manipulate the boom with his feet. With eight persons in the group, you may have as many as seven people holding guy ropes that are attached to the top of the vertical pole. One will then make his way across holding his guy rope as a guide and the other could be ready to pull the boom back after the first person crosses. The $\frac{1}{2}$ inch guy ropes will vary in length, but probably should be 25 feet long. This is a good exercise in teamwork, balance and confidence.

Problem 16 Walk In

Your group represents an exploratory expedition on an alien planet. You have been sent to this planet to retrieve a very delicate instrument which is setting in the center of a volcanic area. You have now found the instrument but the ground around the instrument is producing a very intense heat which hovers six inches above the ground. The twined off area represents the area which you cannot walk on. The only way that you can get into the area is to use the special equipment which reflects the intense caustic heat. This special equipment consists of three small posts and some treated ropes and lies before you. Because of the terrain you must enter the rectangled area from one of the ends rather than the sides. Unless the instrument is lifted out of the hovering caustic heat, it will cause a violent explosion in 20 minutes. Do your best! and good luck!

In order to complete this problem, you will need 2 fence posts that are 8 feet long and a stout crossbar about 6 to 8 feet long. You will need three lashing ropes to lash a bipod together as shown in Figure 429. You will need a special small gaff hook stick or something to lift the instrument out of the heat. Then you will need six $\frac{1}{4}$ inch ropes about 15 feet long. Make the twined off area about 40 feet long and 15 to 18 feet wide. It is absolutely necessary that the group goes in from one of the ends rather than the sides. A big hand alarm clock set to go off in 20 minutes makes a good instrument to retrieve.

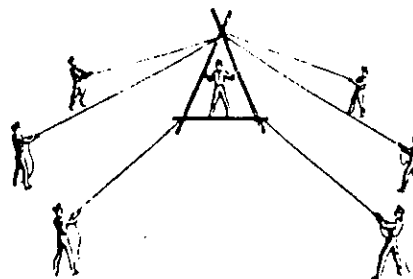

Figure 429 Walk In

Problem 17 Light the Beacon

With only the gear provided, erect a beacon 17 feet high in the exact center of a 30 foot diameter circle. When the tower is up and anchored in position, light the improvised beacon while standing outside of the circle.

The material needed for this problem may be placed inside of the 30 foot circle. It would consist of:

- a. Three 20 foot poles or 2 x 2's
- b. An appropriate tripod lashing rope for above
- c. One piece of twine 40 feet long
- d. One small pulley wheel with attached eye screw
- e. Two candles
- f. One small roll of tape
- g. Matches

The solution to this problem is to build a tripod and put the pulley wheel high up on one of the uprights with the attached eye screw. Then the candle with a good wick must be taped onto one of the other uprights 6 or 8 inches lower than the pulley. With the piece of twine, you must

thread the pulley so it extends outside of the circle where you tape the other candle to the twine. The candle is then lit and hoisted so it will meet and light the other candle. It may be necessary to tape the twine a few inches above the candle so the twine will not get burned.

Problem 18 The Shear Movement

Your boat has capsized in the Florida Everglades and your party is returning to your base camp over the swampland. You have come to an old abandoned concrete "U" shaped spillway that is about three feet deep and starts and ends in the deep alligator infested waters. The spillway is about ten feet across and is filled with deadly man-eating alligators. You may utilize the two trees, one on either side of the spillway. Using only the material at hand can you get your crew across the spillway to safety and back to your base camp??? Good luck!!

The materials for this problem include a twined off area 10 feet wide with a tree on either side, two stout poles about 12 feet long to make shear legs with three crossbars, along with the seven necessary lashings. The seat crossbar should be about seven feet high from the bottom of the shear legs. You will need one long thin tree to be used as a push pole, with a three inch branch stem left on close to the end of the pole to act as a "Y" to grasp the upper crossbar for pushing. Then you will need four 3/8 inch holding ropes about 25 feet long to tie to the poles above the shear lashing to keep the transporter from falling too fast on the far side.

With this material you can build a transporter as shown in Figure 430 and transport one person across the spillway. Then you will need a 30 foot long 3/4 inch or larger rope to make a one rope bridge. The remainder of the group can cross the spillway with the one rope bridge using the American or British Crawl. If one of the group can sit on the shear lashing, the seat crossbar may not be necessary.

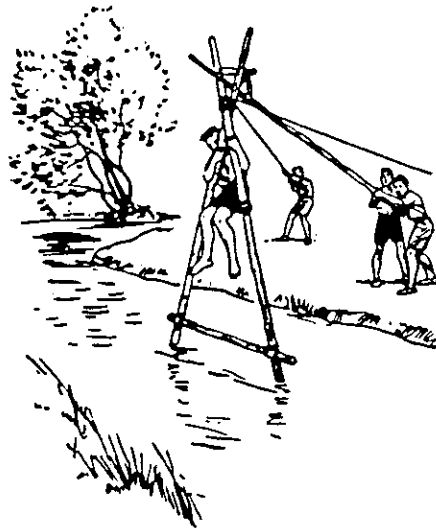

Figure 430 Shear Movement

Problem 19 Flash Flood

Your group is hiking on a canyon floor. The tall vertical walls on either side of the canyon make it impossible to get out unless you could get another five miles down the canyon. About ten feet above you is a comfortable ledge. You have received word on your portable radio that a flash flood is coming down the canyon and it will flood the canyon floor to a depth of eight feet. If you could get your group onto the ledge above it would mean your safety. But alas, you have no equipment. The flood is going to hit your area in 10 minutes. Can you get your group onto the ledge before the flash flood hits your area?

With no material to work with, the solution is to build a human pyramid and help one another on to the ledge. The last man may be lifted with belts, shirts, etc.

Problem 20 Ladder to the Sky

Your group represents a demolition team. Your assignment was to destroy a small warehouse filled with explosives. Your only route of escape is to get your group up to the higher level. With the small amount of time that you have left and using only the materials in front of you can you bridge your escape route in 15 minutes?

For this problem you need an 8 to 12 foot wall to climb or a branch that is ten feet high which represents a wall. Then you will need two 2 x 2's 12 feet long and eight or nine pieces of 2 x 2 about 18 inches long. Along with this, you will need 18 clothesline lashing ropes about 15 feet long.

The solution to the problem would be to lash a ladder with rungs about 18 inches apart and then your party can climb to safety.

Problem 21 Evasion

Your group represents a patrol of American Rangers. Approximately _____ yards from here and on an azimuth of _____ degrees are three red flags containing secret messages. Your mission is to get any one or more of those flags and get them back here. However, between here and the flags are enemy patrols who will try to shoot you. Your job is to infiltrate through the enemy lines, get the flag and infiltrate back to here without being shot by the enemy....Good luck.....You have 30 minutes to capture a flag.

This is strictly a game in which the group tries to capture the flags of another smaller group who are guarding the area with squirt guns. The guards cannot get closer than 50 yards from the flags unless one of the flags are in the process of being captured. When a group member is shot he must go to the flag area as a permanent prisoner. The attacking group uses no weapons. There must be a referee in this game in the area of the flags.

Problem 22 Operation Look-Up

In front of your group is a ten foot vertical pole with an open box on the top of it. The pole cannot be touched because it is coated with a very caustic acid. With just the material in front of you, can you determine what 15 things are in the box? You have 15 minutes to find out and write down the contents of the box. Give your written answers to the staff person in charge. Remember, the pole cannot be tipped over.

In this problem you need the ten foot pole with some sort of box or tray fastened to the top. Inside of the box are 15 small items each laying independently.

The material for this problem include a ten foot lightweight pole, a metal mirror which may be attached to the end of the pole with a piece of wire etc., and then the group will need a pad and pencil.

The solution is to fasten the metal mirror to the top of the pole and with it try to determine the 15 items in the box.

Problem 23 The Footlock

Your group is located on the second floor of a hotel fire in a new hotel which is being built. The only opportunity you can see for an escape is an empty elevator shaft, but it is a sheer two story drop with a concrete floor at the bottom. You do have a 3/8 inch rope which is long enough to reach to the floor. To slide down such a thin rope would give you severe hand burns if you were able to hang on. Can you and your group descend to safety?

For this problem you need a high wall or a high branch where you can tie the 3/8 inch rope and descend to the ground. In this type of a situation you must use the footlock, which is explained on page 109.

Problem 24 The Rock Climber

Fifty miles in the wilds, two rock climbers are rappelling down a cliff. Half way down the cliff is a small ledge where the climbers can get a brief rest and a new rappel point. The first climber has reached the ground safely and the second climber is on the small ledge half way down the cliff but still about 40 feet above the ground. All gear has been sent down to the ground except the cook kit. While trying to fix his rope around the rappel point the climber drops his rope to the ground. How can he get down????

In this problem you need a wall or cliff in which one person is on top and the remainder of the group is at the bottom. The person on top must throw his rope down. Assuming the ledge is 40 feet high, it would be impossible for the team below to throw the rope up to him. On top of the cliff is a regular cook kit with a crocheted holder or hot pad inside.

If one person cannot solve the problem another gets a chance to go to the top until someone discovers the solution is to unravel the holder and send an end down so the rappel rope may be tied on and then hoisted back up. For the short time it takes to crochet a holder, it is worth taking it apart for solving this problem. Most of the time individuals will look into the cook kit, and even see the pot holder, but it doesn't dawn on them to use it.

Problem 25 The Southbound Footprint

We have lent a polaroid camera to your group. Using whatever materials that you can scrounge up, bring back a picture of a southbound footprint. You have 20 minutes to complete your mission. Don't forget to bring back the camera!

The solutions to this problem are many. One solution might be to take a picture of a footprint, with the heel pointing north by compass. Another solution might be to take a picture of a footprint which has a watch and shadow method of finding south set up next to it, so the footprint is pointing in a southerly direction.

Problem 26 The Giant Knot

With the rope in front of you can you tie a clove hitch around the tree? The only problem is that you cannot at any point get closer than ten feet from the tree.

For this problem you need a fairly tall tree with the trunk free from branches and other debris. Put a piece of twine on the ground around the tree so that the circle of twine is about 20 feet in diameter with the tree in the center. You will also need a 35 to 40 foot rope.

The solution is to make a small clove hitch knot and then duplicate it on a large scale around the tree.

Problem 27 First Line Across

Your group has come to a creek. It is too deep to wade across, the current is too fast to swim across and there are no bridges. You cannot walk around. The only gear that you have lies before you. Can you get your group across the creek in the allotted time????

Once more you will have to have two choice trees about 20 to 25 feet apart. One of the trees will have to have a suitable clear crotch or forked limbs about 5 or 6 feet high. The twined off area between the two trees, representing the creek, should be spaced about three feet from the far tree with the forked limbs and about four feet from the near tree where the problem will begin. You will need a short stout three foot long pole or a piece of three foot metal pipe. You will also have to have a 35 to 40 foot piece of $\frac{1}{2}$ inch rope and a small roll of tape.

The solution to the problem is take the rope and tie a round turn and two half hitches around the center of the three foot piece of pipe. Tape the knot on to the pipe so it will not slip to one end or the other. Throw the pipe through the "Y" of the tree so it is well secured. Then tie off the other end of the rope on to the tree on the near side, using a tightening arrangement, if needed. The rope may then be traversed with a British or American Crawl. This problem may also be done with a grappling hook instead of using the pipe and tape.

Problem 28 The Long Saw

Your group is on an alien planet and you have been confronted by a problem. A post is standing vertically in the center of a 25 foot circle. The circle is represented by the twined area. The post is about three inches in diameter and stands about four feet high. It is imperative that six inches be taken off the top of the post because the post is emitting a deadly radiation which is two feet deep but still within the confines of the circle. For this reason you cannot enter the circle. Every 15 minutes the radiation will blast off and the circle of radiation will be doubled. With only the material you have on hand, can your group cut six inches off the top of the pole and save the planet?

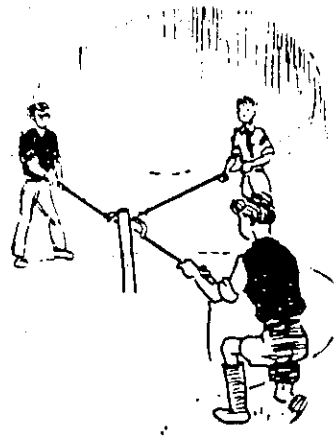

Figure 431 The Long Saw

The only things you have access to are a ball of twine, a ruler and a bow saw. See Figure 431 for the solution to this problem.

Problem 29 The Holtan Hurler

In front of your group is a large twined off area representing an industrial hot oil spill from a new African construction sight. Other members of your Geological Team are on the other side of the canyon and need a large oil resistant rope in order to complete a certain project. It is up to you to get the rope over to them. There are no bridges and no one else who can get a rope to them because of the "river" of oil. Using only the material on the ground can you get the large rope over to them????

The twined off area representing the hot oil spill must be quite wide. The staff person should try the Holtan Hurler to see how far he can throw a golf-ball-sized stone. It should be quite a bit farther than he can throw it by hand. With a little practice, a stone can be thrown a great distance.

The materials needed are a ball of tough string, the heavy "oil resistant" rope, a stone about the size of a golf ball or a bit larger, and a six to seven foot closet pole with a 10 penny nail driven into the end of the pole. The head of the nail should then be cut off. A handkerchief can be used to house the rock.

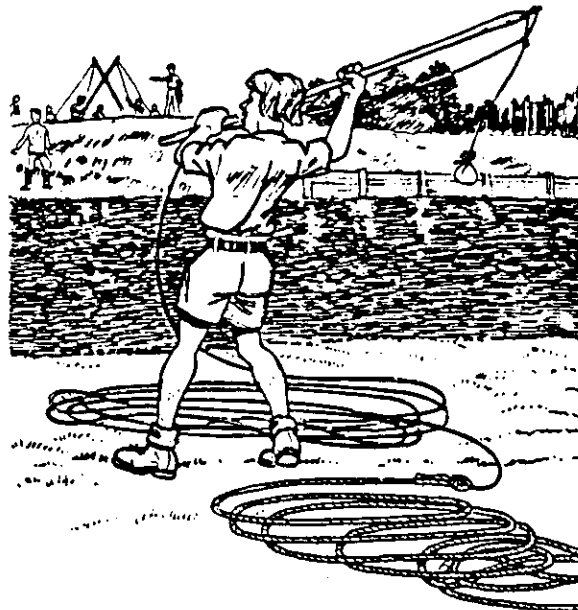

Figure 432 The Holtan Hurler

The solution is shown in Figure 432. The device is a

Holtan Hurler and if the small cord is kept completely free, you can throw a rock a good distance.

Problem 30 Light It Up

A candle stands 15 feet away. Between your group and the candle is an imaginary "no touch" zone which is represented by the twined off area. You cannot go around or cross over. With only the material in front of you, can you light up the candle? Oh, Oh, sorry - we only have two matches left. You have ten minutes!

Materials needed for this problem is the twined off area with a good candle on the far side which won't tip over. You will need five 1/2 to 3/4 inch dowels four feet long with eight four foot lashing cords. You will also need a heavy rubber band to secure the match to the end of the dowel and two wooden matches.

The solution, of course, is to extend the poles with the eight lashing cords. The next step is to scratch the wick of the candle a little so it will light better. Then secure a match to the end of the pole with the rubber band and reach the pole over and light the candle. Do not light the first match with the second match. In the event your first trial flops you will have another match to try again. Light the first match by striking a suitable rock on the head of the match.

Problem 31 Project Three-Dot

This is a problem in logic for groups of three. From this point on there can be absolutely no talking, no questions can be asked and glasses must be taken off and pocketed. Read the story at least twice.

You three explorers represent three persons who have been captured by the Atonga Head Hunters in the Belgian Congo. In a few minutes, the chief of the head hunters will enter and secretly put either a red mark or a black mark on your forehead. You will be able to see the marks on the foreheads of the other two, but you will not know the color of the mark on your own forehead. After your foreheads have been marked, you will look at the other two. If you see a black mark on either one of their foreheads sit down! If you cannot see a black mark on at least one other head, remain standing.

As soon as you have assumed your positions, you must figure out, by logic, what the color is on your own head. As soon as you figure out the color on your own forehead - stand up! If you can intelligently explain why your color is what it is you will be set free and the other two will die. If you guess, and guess right, but cannot logically explain why, you will also die. So, think!!!

To make this a worthwhile problem, have the staff person actually blindfold the three people and mark their foreheads with a magic marker. Then take the blindfolds off and play the game.

Solution: If two people had black marks and one had a red mark, the problem would not be fair to the one with the red mark. The reason

for this is because either or both of the two people with black marks would stand up immediately, because they would know they both would have to be black. However, if all three are black, the reason one of the blacks would stand up is because the other two remain seated. In other words, I must be black because the other two have not stood up.

Problem 32 Project Hypotenuse

A group of explorers set up a campsite. After their campsite was in readiness, they decided to go hunting. They hiked exactly ten miles south from their campsite. They then turned and went exactly ten miles east. At this point they shot a bear. When they checked their map, they discovered they were exactly ten miles from their campsite. What was the color of the bear they shot and why?

This is another short problem in which the group can be broken down into small groups of two or three.

The solution to the problem is that they shot a white polar bear because, theoretically, their base camp was right smack on the geographical north pole.

Problem 33 The Beetle and the Glut

Armed with only a handaxe and a knife, your assignment is to make a beetle and a glut. After you have made the two items, you must split a three foot log which will be given to you using only the home-made beetle and glut.

Be sure the three foot log is a soft wood, such as poplar or pine.

Problem 34 Traverse the Creek

The rope that you see stretched between the two trees is an escape route from head hunters who are about 15 minutes behind you. They would like you for supper. You feel that the distance across is too far for the British and American Crawl, and hand over hand is too tough. Devise a method to cross the snake infested waterway.....You must hurry - you only have 15 minutes before the head hunters arrive. The only material that you have is laying before you.

The material for this problem are two snaplinks, two pieces of 3/8 inch rope 12 feet long and a 35 foot piece of twine.

The solution to the problem is to tie the rope ends together making two loops. Each loop is connected to the horizontal traverse with one of the snaplinks. The traverse can then be crossed with the "Step Slide." In order to get the loops back, so the next person can cross, the end of the twine must be attached to the lead loop so it may be used to pull the loops back.

Problem 35 The UFO

With five 12 inch small sticks of balsa wood, several birthday candles and a plastic suit bag, make a UFO that really flies.

The solution to this problem is to use five small 12 inch balsa sticks that are about 1/16 inch thick and 3/16 to 1/4 inch wide. These may be purchased at most any craft shop. Glue four of the sticks into a flat square with the fifth stick glued diagonally across the square. Secure several candles so they stand up onto the diagonal. Then put this structure into a plastic suit cleaning bag and light the candles. The hot air from the candles will quickly bulge the plastic bag and make it rise. Be sure to tether the UFO with a strong thread so it doesn't get away from you. You may have to seal some of the open ends of the plastic bag with scotch tape.

Problem 36 Survival Camp

Your group represents a few lost souls surviving in the wilderness after a plane crash. You are prepared to signal searchers, you have water and good shelter. However, you are hungry. In the allotted time scout the area and see how many wild edible plants you can find. Then gather a portion and be ready to prepare them for eating.

The best way to work this problem is to make an added dish of wild edible plants to go along with a pre-made lunch.

Problem 37 The Hoist

With the material provided, erect an apparatus in which several people can get to a high limb of a tree with only one member of the group having to climb the tree.

Material needed for this problem include a suitable block and tackle, a boatswain's chair which may be attached to the hook or eye of the block, and some twine.

The solution to the problem is to find a suitable tree with a high limb. You might consider using a ladder to the limb so individuals can get out of the bosun's seat, onto the limb and then they can climb down the ladder. If this method is used you may need a piece of twine between the bosun's chair and the ground so the seat can be pulled back down to the ground. If desired, the members can go up the self-lifting hoist one at a time, ring a bell and go back down using the block and tackle.

Problem 38 Signalling

Your group represents survivors from a plane crash in the Canadian wilderness. Before the crash the pilot managed to radio your position. Because of the wooded terrain, your group feels that you must prepare to signal searchers. The only thing you have to start fire with is the material in your damaged survival kit. Make a fire and show the difference between white and black smoke and tell which you would use in this case. You have 15 minutes.

The material needed for this problem are several magnifying glasses and/or flint and steel sets, along with some strips of lamp wicking to use as punk for the magnifying glasses. These items are from the damaged survival kit. You should also have a piece of old rubber inner tube, some old oily rags and a small freshly cut pile of green brush.

The solution is to build a small fire with the sun and glass method and/or the flint and steel method, and after the fire is burning well lay the green foliage onto the fire so as to make a white smoke, which is what you need in the dark background of the wilderness area. After you have produced a lot of white smoke, rake off the green foliage and burn the rubber and oily rags. This produces a black smoke and is used for signalling on the snow or an area with a light background.

Problem 39 Castings

Within a 25 foot radius of this spot you must find an animal track, identify the track and make a positive and negative plaster casting.

Materials needed include a small box of plaster of Paris, a bottle of water, a mixing container, some molding compound or putty, and a suitable animal track. If there are no tracks to be found, you can buy or borrow plastic models of animal footprints. The soil can be dampened a little and it becomes an easy chore to imbed a footprint. The plaster of Paris is used to make the positive casting by pouring a plaster of Paris batter into the hollow of the footprint. When dry, the positive may be removed and it can be stamped into the moulding compound or putty to make the negative casting.

Problem 40 Measure the River

Your group has reached Point Y in a river or twined off area. You want to know the distance across to Point X. There is no means of crossing the infested river. By using your pioneering ingenuity can you determine the width?

The solution is shown in Figure 433.

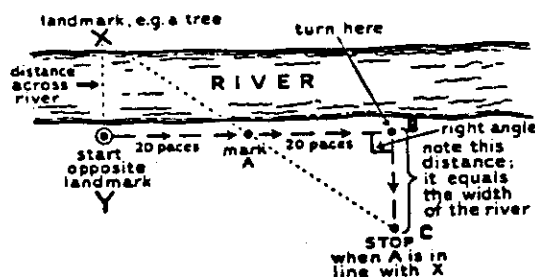

Figure 433 Determining the Width of a River

Problem 41 Azimuth to Freedom

Your group has been captured by hostile natives and is being put to the measurement and compass test. If your patrol can find a certain number in 15 minutes they will be set free. If you cannot find it your group will be put to death. Before you is a compass on a stake. Exactly ___ feet from the stake on a true azimuth of ___ degrees is a number imbedded into the top of a stake. The stake has been driven into the ground so that the top of the stake and number are at ground level. You have 15 minutes to find the number. Can you find it in time to save your patrol?

The material and solution to this problem is self-explanatory. Put a compass on a stake. Measure a distance on a certain azimuth or two and let the group do their thing.

Problem 42 The Pants Putteroner

Your group is to build an apparatus which will put a pair of pants on their subject by remote control; that is, nobody including the subject is allowed to touch the pants during the process of putting them on.

This makes a fun problem and I have seen it done in many different ways. See what your group can do with it.

Problem 43 The Whifflepoof

The person giving you this is blind. He is fluent in Kurdustani. He speaks no other language. The trail to the next problem has been marked by a WHIFFLEPOOF. A Whifflepoof is a log embedded with nails and spikes. You will first have to imagine what kind of a trail such an object would make. You will then have to find such a trail. Then you will have to follow the trail. Happy Trails!

Figure 434 shows a picture of a whifflepoof and how to mark a trail with it. Make a trail with it for 10 to 15 minutes. The trail may go over wood or concrete slabs or even through water as long as the trail can be picked up someplace on the other side. Use your imagination. This makes a good exercise in trailing and observation. It also makes a good timed event.

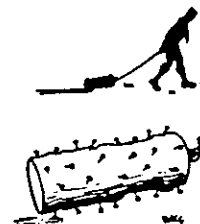

Figure 434 The Whifflepoof

Problem 44 The Land Raft

Your group is exploring a strange new planet. A team of androids, who wish to do you bodily harm, are 20 minutes in hot pursuit behind you. You have come to an area on the planet, represented by the twined off area, which must be crossed. There is no way around it. Explorers before you have determined that if you get within six inches of the ground area, an instant life-taking paralysis develops. The androids are also affected by this. It has also been determined that if metal or wood is dragged through the "no touch" zone, handling it will have no effect on an individual. The only material that you have to help you cross the area lays before you. Can you save your group from the androids?

The twined off area should be about 20 feet wide on flat ground. The problem works best with four to six persons in the group. If a group is a lot larger, the problem can be done twice.

The materials needed are six 20 to 30 gallon empty drums, a 4 x 8 foot sheet of 3/4 inch plywood and three 2 x 2 inch poles six to eight feet long.

The solution to the problem is to make a land raft which has two drums, a few inches apart, side by side. In line and three feet behind these two drums, are two more drums and another three feet behind the second set of drums is a third set of drums. The sheet of plywood is then laid on top of the six drums to complete the land raft. The group then gets onto the raft with the push poles, and the raft is then set into motion. When the two drums in back of the raft are ready to be exposed, the group must shift their weight in such a way that one of the members can grab the barrels from behind (one at a time) and place them under the front end of the raft. In this manner the raft can be kept going, and if weight and balance are shifted properly you will be able to raft across the "no touch" zone.

Problem 45 The Log Walk

Once more our group has to cross a poisoned strawberry yogurt area without touching the ground. The only materials to help lay before you.

For materials you will need a twined off area about eight to ten feet wide, a smooth cylindrical log about ten to twelve inches in diameter, and two to three feet long, and a couple of smaller poles about six feet long to act as guide poles.

The solution to this problem is to walk the log using the two poles to balance yourself as you shuffle along to the other side.

Problem 46 Operation Air Drop

It is quite easy to find a pilot who loves to fly planes for a hobby. It is also easy to find an old parachute. If there are no shroud lines on the chute, it is an easy job to attach a few shroud lines using several pieces of twine. The chute can be rolled up and at the end of the shroud lines you can fasten or attach a burlap or canvas bag filled with unlabeled cans of food or anything else that you may want to imagine. At the specified time and place, the pilot flies over your area and tosses out the chute and supplies to your group. This makes a good survival problem - to have your group prepare to signal searchers, build a shelter with the chute and prepare lunch with the unlabeled cans of food. With this type of a problem you can have many ramifications.

Problem 47 The Red-Hot Isobar

Your group cannot enter the roped off area because of the isofetfets. Your mission is to pick up the pail of aqua pura and set it into the drum using the apparatus which your superiors have built.

For this problem improvise an apparatus as shown in Figure 435. It should be 10 to 15 feet square with an eight foot pole in each corner rigged with a small pulley. For a larger group, more than four outer poles may be equipped and used. A rope or twine, three feet high, should be placed around the four poles. The fencing material, as shown in the figure, is not necessary. In one corner is a five gallon pail, or larger

drum if desired. In the middle of the area is a board with a regular water pail standing on it filled with water. Floating on the water is a smaller board with a burning candle stump attached to it.

If you can find four trees which are reasonably spaced, you can fasten the small pulley to the trees with a cord and run your roped off area around the four trees.

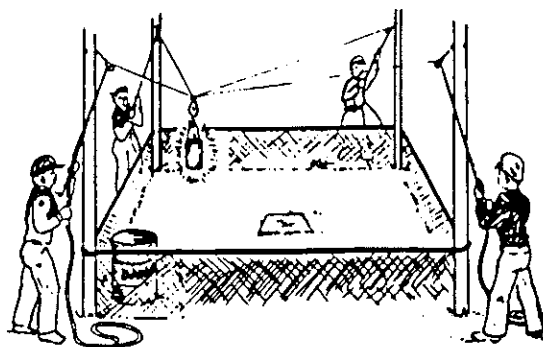

Figure 435 The Red-Hot Isobar

This makes a good exercise in teamwork and points can be taken away for spilling water or for dousing the candle. The solution is to get the pail into the drum using the pulley arrangement.

Problem 48 Oscillating Vibrations

Your group represents a team of experts from the Intelligence Security Division of NASA. You have been sent to this area to find a spot in this twined off area. Several people have reported that somewhere in this area there are weird vibrations which may be an indication of a very rare product called "Orkon." NASA has sent an Oscillograph to aid you in finding these vibrations if they are present. Orkon is highly explosive if exposed to air so you must use utmost care. It also emits lethal rays so you can only stay at this project for ten minutes. Sweep the area carefully with the oscillograph and see if you can pick up the vibrations. Good Luck!!!

The equipment needed for this problem consists of a raked twined off ten foot square in a sandy area. Somewhere in the square, a flat piece of heavy iron metal is buried just beneath the surface of the ground. The oscillograph is just a five foot piece of 1 x 2 with a permanent magnet attached to the end of it. The magnet, however, should be able to lift at least ten pounds. When sweeping the area, the magnet should be held about an inch from the sand. When the magnet is swept over the area where the metal is buried, a pulling vibration will be felt. This problem takes patience and concentration. Each member of the group should have a chance to comb a part of the area with the oscillograph.

Problem 49 Who Are These Men?

Obtain an 8½ x 11 inch print, sketch or picture of three famous men such as Lincoln, Washington and Kennedy. If the pictures are not on the same type of paper and approximately the same size, have the pictures copied on a copy machine so the pictures are about the same size and on the same kind of paper. Cut each picture into eight "jig saw" type parts and put one piece of each picture into an envelope. Each envelope will also contain a cryptogram (a communication in cipher or code).

To start the problem give the group a piece of paper with a short cryptogram written on it which will lead them to the first envelope. In this envelope, they will receive their first three pieces of the puzzle of the three different men. In this envelope there should also be a second and different coded message leading them to the second envelope. This continues with a different code or cipher in each envelope until all 24 pieces of the puzzle are obtained. Then, of course, the problem is to try and sort out the 24 pieces so as to identify the three different men.

It may be necessary to have a few copies of each picture so that the staff person can practice cutting up a picture so it cannot be identified after the first few envelopes are acquired.

Problem 50 The Coral Reef

Three of your ship wrecked group have failed to reach the island. Instead they have managed to cling to a coral reef which is about 20 feet in diameter and about 40 feet from the island. None of your group can swim and the water between the coral reef and the small island is very deep. Your group has managed to salvage the material you see before you from the wrecked ship. The rest of the members of your group are on the island and they too have a small amount of equipment. If you could join forces with them you would have ample protection against the oncoming cannibal canoes. With just the material before you and with the help of the people on the island, can you join forces and save your group?

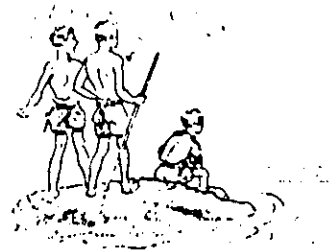

The material needed for the three persons on the coral reef is as follows:

- a. Seven 4 to 5 foot closet poles (or similar poles)
- b. A two inch band of inner tube about six feet long
- c. Two 50 foot half inch manila ropes
- d. 250 feet of twine, 200 feet to be used as a throwing line
- e. A suitable rock that one end of the twine throw-line may be tied to
- f. Cigarette lighter
- g. Knife

In the event the question comes up, the group on the island has all of the necessary gunpowder to scare off the natives except the matches.

To solve the problem, the three persons on the coral reef must make a giant sling shot like the one in Figure 436. They must attach the twine to the rock and propel the rock to the island. The islanders then pull over the manila rope which has been attached to the twine throw-line.

The people on the reef then build a makeshift pole raft as shown in Figure 437, and one by one they are pulled over to the island. Of

course, they must be sure to attach the second 50 foot manila rope (or polypropylene) to the improvised raft so they can get the raft back to the coral reef for the second and third passengers.

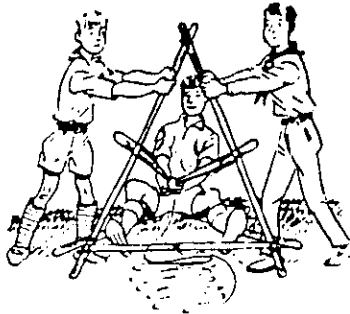

Figure 436 Giant Sling Shot

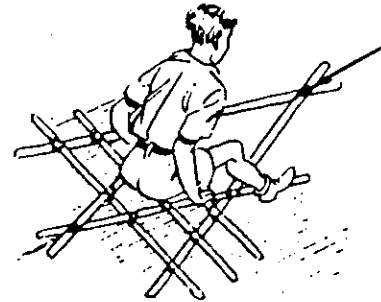

Figure 437 Improved Pole Raft

So, like the group challenges the problems could go on to infinity. Almost any problem can be created from nearly every situation. Problems are fun to conceive and a group has a fun time in solving them.

As in the last two chapters, we are leaving empty space for a few of your own ideas as they come up. The problem can be abridged until you want to use it. Examples might be:

51. Making and using commando ropes to build a commando bridge.
52. Building a shelter in a coming sandstorm.
53. Lowering an injured climber from a high platform.
54. An incendiary field - paper stuffed bags with different length candles.
55. _____
56. _____
57. _____
58. _____
59. _____
60. _____
61. _____
62. _____
63. _____
64. _____
65. _____

GLOSSARY OF TERMS

- "A" Frame - Two sturdy poles, 8 to 10 feet long, about 3 inches in diameter lashed together at the top with a sheer lashing to form an inverted "V". A transom or ledger is usually not indicated.
- Abseiling - European term for rappelling.
- Agonic Line - The imaginary line running around the earth where there is no magnetic declination and where a freely suspended magnetic needle indicates true north.
- Aid Slings - An etrier or 3 or 4 loop rope ladder used as stirrups for climbing.
- American Crawl - Crossing a rope suspension by hanging the body under the rope and traversing by walking with hands and ankles.
- Anchor Rope - A rope tied to an anchor to secure a belayer, "A" frame, and various other objects.
- Belaying - To secure or to be secured with a rope against a possible fall by the climber.
- Blocks and Tackle - A simple machine or mechanical device comprising two or more blocks through which a rope has been reeved to increase pulling or lifting power.
- Boatswain's Chair (Bosun's Chair) - A simple sling or seat for one man to cross a horizontal traverse or hang from a vertical wall, etc. It may have a rope seat such as made with a bowline on a bight or it may have a wooden seat such as a notched board.
- British Crawl - A method of crawling on top of a rope by laying on the chest with one leg and foot hooked over the rope and letting the other leg hang down, pulling with the hands. One may also push with hooked foot.
- Cableway - is used to cross a single depression or stream that would otherwise be difficult to traverse. Intermediate towers are not used.
- Chock-A-Block - A term indicating that the blocks in a tackle have been drawn together so that no further pull is possible.
- Cipher - is a method of transforming a text in order to conceal its meaning.
- Code - A system of symbols such as letters, numbers or words used to represent assigned and often secret messages.
- Commando Crawl - Same as British Crawl.
- Commando Ropes - Same as Toggle Ropes.
- Cross-Bearing - A method to determine exact location by using two prominent land features at least 40° apart.
- Cryptography - The enciphering and deciphering of messages in secret code.
- Declination - The horizontal angle between the direction of true north and magnetic north, variable according to geographical location.

Derrick - A simple form of crane consisting of a single pole, usually hinged at the butt so that it can be swung, raised or lowered.

Dynamic Belay - Where the belayer allows the rope to run through his hands as he gradually brings his braking hand across his body to produce braking action. This results in a gentle halt to climber or cargo and less strain is put on the rope, belayer and climber.

Exposed Climb - A climb from which a fall would be severe or fatal.

Free Climbing - Climbing without a rope or other aids.

Gin Pole - A guyed single upright pole equipped with suitable hoisting tackle and used for lifting heavy loads.

Grappling Hook - A hook consisting of 3 to 5 tines which are fixed to the end of a rope so that the rope may be attached to an object by throwing and catching the hook.

Horizontal Rope Traverse - A rope installation used to bridge rivers, streams and ravines.

Ledger - The horizontal pole across the legs of a trestle or shear legs near the butt ends.

Lower Belay - A belay which may go directly up to the climber or the belay rope may run from the belayer, below, to above the climber to a belay point and then back down to the climber.

Mousing - To close the mouth of a hook by wrapping and tying a cord around the throat of the hook to keep the hook from upsetting.

Orientation - A method of determining one's location in the field with the help of landscape features, map, or compass, or all three combined.

Pace Counting - Measuring distance in the field by counting double steps.

Piton - A metal wedge driven in rock or ice used to provide support.

Prusiking - The art of climbing a pole or large rope with two pieces of 16 foot ropes and the prusik knot.

Quadripod - Consists of 4 sturdy legs lashed together at the top to form a weight bearing structure such as for a Chippewa table.

Rappelling - The process whereby a climber lowers himself by sliding down a climbing rope.

Reeving - The act of passing a rope through a block to form a tackle.

Rope - A strong cord made of intertwisted strands of natural or artificial fiber.

Rope Sling - A smaller short length of rope or webbing fashioned into a loop. Common sizes are 18 inches, 3, 6, and 10 feet. Some of the uses are around a tree or stone as a belay point, as a piton extender, as a rappel or chest sling or prusik sling, etc.

Seizing - Binding with light cordage to secure the end of a rope, or a loop, to the standing part.

Shear Legs - An apparatus consisting of two upright spars fastened together at their upper ends with a shear lashing. It is usually used for tackle, fastening, lifting loads, towers for cableways and rope bridge operations. It usually has a spar or rope for a ledger across the lower end of the uprights.

Sling - May be made of rope, wire rope, or chain. They are usually an endless type of sling or a sling with a loop on each end. Slings can be of any length, usually about 6 feet long.

Static Belay - Where the belayer applies the braking action of locking the arm across the body with utmost speed. When applied, it creates sudden and sharp halts to the person or cargo being belayed.

Strop - A short rope with its ends spliced together to form a circle.

Strop - A leather band for sharpening razors, etc.

Suspension Traverse - A rope installation used to bridge ravines, rivers, streams or cliffs.

Tackle - The apparatus of blocks and ropes for lifting, lowering and pulling.

Tension Climbing - Climbing with the aid of pitons, snaplinks and etriers.

Toggle Rope - A rope with a loop on one end and a wooden or metal "T" peg on the other end. They are easily joined to form a longer rope.

Topographical Map - The detailed, accurate description of land transferred to a map sheet, a representation on a map of natural or artificial features.

Tramway - A cableway system used to cross a series of depressions; thus, a tramway can cover a much greater distance than a cableway because of the intermediate towers.

Transom - The transverse pole or brace in a structure. It is usually across the top of a trestle.

Traversing - Ascending or descending diagonally instead of straight up or down; also, moving across a rope laterally.

Trestle - A rigid structure of 6 poles lashed together with 2 legs, 2 horizontal cross members (the transom and the ledger) and 2 diagonal braces.

Tripod - Consists of 3 legs lashed at the top. It is usually more stable than shear legs, but a load can only be moved up and down.

Tyrolean Traverse - A method of making a lateral movement by the use of a one rope bridge and rappel seat, pulling with the hands.

Upper Belay - A belay in which the belayer is anchored above the climber.

Vertical Hauling Line - A rope installation for moving equipment or personnel up vertical or near vertical pitches.

Whipping - Binding the ends of a rope with cord to prevent fraying or unlaying.

I N D E X

- "A" Frame, 59, 286
- Absciling, 116
- Acre, 152
- Adz, 19, 46, 47
- Aerial Runway, 140, 141
- Aerial Torpedo, 235
- Agonic Line, 162, 163, 286
- Aircraft Compass, 160
- Altitude, Relief and Contours, 156
- All Aboard, 255
- All-Purpose Sheath Knife, 10
- American Broadax, 19
- American Crawl, 136, 137, 139
- American Whipping, 68
- Anchor Knots, 73, 82
- Anchorage:
 - Artificial, 102
 - Bear Claw, 104
 - Deadman, 104
 - Earth Auger, 103
 - Grapnel, 104
 - Log and Picket Holdfast, 104
 - Natural, 102
 - Single Picket Holdfast, 103
 - 3-2-1 Picket Holdfast, 103
- Anchoring the Belayer, 127, 128
- Angle of Declination, 162
- Antarctic Zone, 147
- Arctic Zone, 147
- Arkansas Sharpening Stones, 13
- Ascenders:
 - Gibbs, 115, 116
 - Jumar, 115
 - Kong, 115
- Asiatic Hemp, 63
- Astronomy:
 - Orion, 221
 - Southern Cross, 223
 - Ursa Major, 220
 - Ursa Minor and Polaris, 220
- Augers, 48
- Australian Two-Poncho Raft, 182
- Autumnal Equinox, 218, 219
- Axes:
 - Broadax, 18
 - Caring for, 33
 - Cruiser, 22
 - Double-Bit, 22
 - Felling, 17
 - History of, 15
 - Hand Ax, 17
 - Handles or Helves, 23, 24
 - Honing, 33
 - Light Weight, 17
 - Logger's Ax, 17
 - Middle Weight, 17
 - Nomenclature of, 16
 - Parts of, 16
 - Poll, 16, 17
 - Safety, 33
 - Sharpening, 31
 - Single-Bit, 16, 17
 - Styles of, 17
 - Types of, 17
 - Woodland Camping, 17
- Axmanship:
 - Bucking, 27
 - Chopping, 29, 30
 - Felling, 25
 - Hewing, 27
 - Logging, 26, 27
 - Lopping, 30
 - Splitting, 28
 - Trimming, 26
- Azimuth, 162
- Bachmann's Knot, 116
- Back Cut, 25
- Barrel Raft, 178
- Bars:
 - Crowbar, 55
 - Gooseneck Wrecking, 55
 - Pinch, 55
- Basic Knot Elements, 72
- Bearing, Compass, 162
- Becket, 53
- Beetle and Glut, 28
- Belaying:
 - Devices:
 - Figure-of-Eight Descending
 - Belay Plate, 125, 126
 - Spring Loaded Stitch
 - Belay Plate, 125, 126
 - Stitch Belay Plate, 125, 126
 - Introduction to, 124
 - Types of:
 - Dynamic, 124
 - Lower, 124, 127
 - Sitting Hip, 129
 - Static, 124
 - Upper, 124, 128, 129
- Big Dipper, 220
- Binnacle, 161
- Bird Knife, 8
- Blacksmith's Hammer, 46, 48
- Blocks, 53
- Block and Tackle, 46, 52, 106
- Block and Tackles:
 - Mechanical Advantage, 53-55
 - Parts of, 53
 - Types of, 53
- Blood Groove, 11
- Boatswain's Chair, 138, 139, 240
- Body Harnesses, 119-121
- Bolas, 246
- Bolster, 9
- Bolt Cutter, 45, 48
- Booby Traps:
 - Multi-Action Device, 227
 - Nomenclature of, 224
 - Pressure Device, 226
 - Pressure Release Device, 226
 - Tension Release Device, 227
- Boom Derrick, 62
- Boot Knife, 12
- Bosun's Chair - See Boatswain's Chair
- Bow Saw, 39
- Bow Saw Blades, 39
- Bow Saw Swedish Style, 237
- Boxing the Compass, 161

I N D E X

Brace and Bits,	46, 48
Breaking Strength of Rope,	65
Breaking the Current,	174
Bridges:	
Commando,	142
Friction,	248
Lazy Man's,	143
Monkey,	143
One Rope,	132, 135
Revolving Derrick,	251
Three Rope,	143
Two Rope,	142, 143, 252
British Crawl,	136, 137, 139
Broad Hatchet,	21
Broadax,	18
Brush Boat Raft,	179
Brush Raft,	179, 180
Bucking,	27, 42
Bucksaw,	37, 38
Bull Boat,	179
Buoyancy and Draft,	173
Bushcraft,	244
Bushman Tooth Saw Blades,	39
Caber Tossing,	235
Cable Gripping Tool,	46, 52
Cable Knife,	8
Cable Laid Rope,	65
Cable Saw,	41
Cableway,	59, 142
Cant Hook,	46, 50
Carabiner Snaplinks,	112, 114
Catamaran,	182
Challenges (See Group Challenges)	
Chest Harness,	121, 122
Chippewa Table,	251
Chock-A-Block,	286
Chock Rope Climbing,	110
Chocks,	110
Choil,	11
Ciphers,	228
Civil or Political Townships,	151
Clasp Knife,	6
Climbing (See Rope Climbing)	
Climbing Equipment,	114
Climbing Walls,	122-124
Coal Sack,	223
Codes:	
Code Wheel,	229
Deaf-Mute Hand Alphabet,	230
Improvised Codes,	230
Introduction to,	228
Invisible Writing,	230, 231
Personal Code,	229
Secret Code Panel,	229
Colling Rope,	66, 67
Commando Bridge,	142
Commando Ropes,	129, 130
Commemorative Knives,	9
Compass:	
As a Watch,	171, 172
Bowl,	161
Card,	161
Declination,	162
Deviation,	164
Compass (Continued)	
Error,	164
Field Exercises:	
Azimuth to Treasure,	170
Equilateral Triangle,	171, 241
From Rim to Hub,	170
Line Orienteering,	170
Rendezvous at Base Camp,	171
History of,	159
Land,	160, 164
Making a Compass,	164
Types of,	159
Congressional Townships,	150
Connecticut Ax,	16
Constellations:	
Orion,	221
Southern Cross,	223
Ursa Major,	220
Ursa Minor and Polaris,	220
Contact Method of Chopping,	30
Contour Lines,	157, 158
Coracle,	181
Cotton Rope,	64
Cross-Bearing,	286
Crosscut Saws,	36
Crossing a Swift Stream,	173
Crown Knot,	94
Cryptograms,	229
Cryptography,	228
Curved Claw Hammer,	46
Cutter Mattock,	46, 47
Daisy Chain,	115
Dayton Ax,	16
Deadman Anchorage,	104
Declination,	162, 286
Declination Chart and Diagrams,	153, 163
Decorative Knives,	9
Demonstrations and Learning	
Experiences,	233-258
Determining:	
Directions from Moon,	221
Directions from Stars,	220, 221
Directions from Sun,	210
Distances,	206, 207
Geographical South Pole,	223
Heights,	208
Latitude,	222
Numbers,	207
Sunset,	208
Time,	214, 223
Widths,	209
Detonator,	224
Developing Codes,	230, 231
Deviation,	164
Dial Compass,	160
Diaper Slings,	120-121
Directions from the Sun,	210
Double-Bit Axes,	22
Double Bit Axes:	
Crown,	16
Michigan,	16, 22
Pennsylvania,	16
Reversible,	16, 22
Swamping,	16, 22

I N D E X

- Double-Bit Axes (Continued)
- Wedges, 16, 22
 - Western, 16
 - Double Block, 53
 - Double Butterfly-Prusik Tightening
 - Arrangement, 108
 - Dovetail Notches, 238
 - Drawknife, 12, 47
 - Drawshave, 12, 47
- Earth Augers, 48
- Easterly Declination, 162
- Ecliptic, 218, 219
- Electrician's Knife, 8
- End Knots, 73
- Equilateral Triangle, 171, 241
- Equinox, 211, 212, 218, 219
- Autumnal and Vernal, 218, 219
- Escutcheon Plate, 11
- Estimations:
- By Sound, 207
 - Distances, 206-207
- Directions:
- From Moon, 221
 - From Sun, 210
 - Plumb Bob, 217
 - Shadow Tip, 213
 - Shadowless Stick, 212
 - Shortest Shadow, 215
 - Staff and Circle, 217
 - Stars, 220, 221
 - Sun and Watch, 211
 - General, 206, 207
- Geographical South Pole, 223
- Heights:
- Artists, 208
 - Lumberman's, 208
 - One in Twelve, 209
 - Shadow, 209
- Latitude, 222
- Numbers, 207
- Personal, 206
- Sunset, 208
- Time by Degrees, 223
- Time by Shadow Clock, 214
- Widths:
- Cap Method, 210
 - Napoleon, 209
 - Stick, 210
- Etriers, 111
- Evacuations, 130
- Exploding Fountain Pen, 224
- Eye Hook, 106
- Felling Ax, 17
- Felling Trees with a Saw, 43
- Felling Trees with an Ax, 25
- Field Dressing Knife, 9
- Files, 49
- Filing an Ax, 32
- Fillet Knife, 10
- Fires:
- Fireplaces:
 - Above the Ground Pit, 205
 - Altar, 201
- Fireplaces (Continued)
- Backlog, 198
 - Bridge, 205
 - Buffalo, 200
 - Chinook, 198
 - Closed Trench, 197
 - Council, 203
 - Crane, 205
 - Crisscross, 202
 - Dakota, 200
 - Fire in the Hole, 199
 - Friendship, 203
 - Gypsy, 205
 - Hunters, 196
 - Imu, 204
 - Indian, 199
 - Lazy Man's, 200
 - Log Cabin, 202
 - Nomad, 194
 - Open Trench, 197
 - Pyramidal, 196
 - Reflector, 201
 - Rock, 195
 - Sod, 194
 - Star, 200
 - Steam Pit, 204
 - Stone, 195
 - Teepee, 196
 - Three Point, 194
 - Trapper's, 196
 - Trapper's Reflector, 196
 - Tri-Level, 199
 - "U" Wall, 195
 - Vigil, 201
 - Western Keyhole, 195
 - Wigwam, 196
- Lays:
- Crisscross, 193
 - Crossed Ditch, 193
 - Fire Stick, 193
 - Half Teepee, 192
 - Lean-To, 193
 - Teepee, 192
 - Needs for, 190
 - Starting a Fire, 191
 - Tips on Campfires, 190
 - Triangle, 190
 - Wood, 191
- Firemaking, 191
- First Line Across, 132
- Fisherman's Knife, 8
- Fixed Loops, 73
- Flat File, 49
- Floatation Devices: (See also Rafts)
- Canteen Float, 176
 - Lone Log, 177
 - Plastic Jugs, 176
 - Poncho Life Raft, 176
 - Water Wings, 175
- Floating Log, 250
- Flying Ferry, 188
- Footlock, 109, 110
- Free Rope Climbing, 109, 287
- Friction Bridge, 248
- Fruit Knife, 8

I N D E X

Fuller or Blood Groove,	11
Fuzz Stick,	234
Gear Sling,	114
Getting a First Line Across,	132
Gibbs Ascenders,	115
Giggly,	41
Gin Pole,	57, 58, 287
Glut and Beetle,	28
Grappling Hook,	123, 124, 136
Grappling Stick,	135
Grid North,	153
Group Challenges:	
Age,	246
All Aboard,	255
Artists,	255
Astronomy Hike,	254
Azimuth to Treasure,	247
Balance Beams,	257
Beauty,	254
Biscuit Baking,	249
Blind Obstacle Course,	246
Blind Polygon,	250
Booby Trapped,	257
Bouillon Problem,	249
Castings,	257
Chippewa Table,	251
Coded Treasure Hunt,	246
Craft Hike,	254
Creek Scanning,	254
Deducting Detective,	255
Derrick Bridge,	251
Egg Drop,	246
Fairy Night Hike,	254
Floating Log,	250
Flood,	249
Friction Bridge,	248
Gold Rush,	254
Handicapped,	245
Hanging Teeter Totter,	249
Hippopotabugs,	256
Ice Melt,	256
Improvised Spears,	246
Incher Hike,	254
Indian History Recording,	254
Insect Screen,	254
Jiggler,	251
Kitten Crawl,	252
Lift the Heavyweight,	248
Lost Child Search,	245
Maze,	249
Meet a Tree,	253
Metal Detector,	246
Mine Field,	256
Mini Safari,	253
Moving Stepping Stones,	252
Natural Pigmentation,	256
Night Flight,	249
Nitro Transporter,	253
No-Touch Beam,	250
Observation Post,	248
Operation Blue Dogs,	246
Popcorn Trail,	254
Porthole,	250
Prepare an Egg,	248

Group Challenges (Continued)	
Public Hearing,	253
Rainstorm,	246
Reach for the Sky,	253
Realistic First Aid,	245
Scavenger Hunt,	248
Sling,	247
Sling Shots,	246
Sloppy Campsite,	253
South American Bolas,	246
Spot the Spot,	256
Step-Slide,	256
Stream Race,	245
String Burning Contest,	248
Summer Snowshoes,	246
Sun and Glass,	255
Survival Hike,	254
Tension Traverse,	250
Toboggan Walk,	253
Traffic Jam,	251
Trolley,	255
Un-Nature Trail,	254
Water Shortage,	248
Wild Edible Plants,	245
Grub Hoe,	46, 47
Gun Tackle,	239
Gyrocompass,	159
Gyromagnetic Compass,	159
Half Hatchet,	21
Handax,	17
Handax Throwing,	236
Hand Tools:	
Chopping,	46
Cutting,	45
Digging and Grubbing,	46
Drilling and Boring,	46
Measuring and Layout,	46
Sharpening,	46
Specialty,	46
Hanging Teeter Totter,	249
Hardening and Tempering,	4
Harvester's Hitch,	107
Hatchet,	21
Hawsers,	65
Hayman's Hitch,	107
Helper Bars,	46, 54, 56
Hitches and Ties,	73-76
Hoists,	46, 52, 105
Honing a Knife,	13
Hudson Bay Ax,	16
Hypothetical Problems:	
Introduction to,	259
Problems:	
Azimuth to Freedom,	280, 281
Beetle and Glut,	278
Castings,	280
Commando Flight,	266, 267
Coral Reef,	284, 285
Determine Your Position,	265
Evasion,	273
First Line Across,	275
Flash Flood,	272, 273
Footlock,	274
Giant Knot,	275

I N D E X

Grappling Stick,	267, 268	
Hoist,	279	
Holtan Hurler,	276	
Kickbridge,	270	
Ladder to the Sky,	273	
Land Raft,	281	
Light It Up,	277	
Light the Beacon,	271, 272	
Log Walk,	282	
Long Saw,	276	
Mad Bomber,	263, 264	
Measure the River,	280	
Operation Air Drop,	282	
Operation Lookup,	273, 274	
Oscillating Vibrations,	283	
Pants Putteroner,	281	
Peter's Dilemma,	269	
Piranha Pool,	261	
Pit,	263	
Plutonium Search,	262	
Pole Climb,	267	
Prison Camp Rescue,	264, 265	
Project Hypotenuse,	278	
Project Three Dot,	277, 278	
Radiation Release,	261, 262	
Radioactive Isotope,	260	
Radioactive Waste,	266	
Reaching for the Word,	265	
Red Hot Isobar,	282, 283	
Rock Climber,	274	
Shear Movement,	272	
Signalling,	279, 280	
Southbound Footprint,	275	
Survival Camp,	279	
Traverse the Creek,	278	
U.F.O.,	279	
Walk In,	271	
Whifflepoof,	281	
Who Are These Men?,	283, 284	
Ice Raft,	182	
Improvised Telegrips,	51	
Inductor Compass,	159	
Index Contour,	157	
Inner Tube Raft,	178	
International Date Line,	147, 148	
International Morse Code,	229	
Invisible Writing,	230, 231	
Jack Knife,	6-9	
Jacques De Liege,	1	
Jersey Ax,	16	
Jiggler,	251	
Jugs, plastic,	176	
Jumar Ascenders,	115	
Jute Rope,	63	
Kelvar Rope,	64	
Kerf Notches,	25, 35	
Kickbridge,	133	
Kipling, Rudyard,	243	
Kim's Games,	243	
Kindling,	191	
Kitten Crawl,	252	
Knives:		
Belt,	3	
Care of,	13	
Classification,	2, 3	
History of,	1	
Honing,	13	
Household,	2	
Jack Knife Nomenclature,	9	
Kinds of,	2	
Making Pocket,	3	
Pocket,	3	
Sharpening,	13	
Sheath,	3	
Sheath Knife Nomenclature,	11	
Tradesman's,	3	
Knot Classification,	73	
Knot Elements,	72	
Knots:		
Bachmann's,	116	
Blood,	75	
Bow,	80	
Bowlines:		
Cowboy's,	85	
French,	86	
Left Handed,	85	
On a Bight,	86, 90, 131	
On a Coil,	87	
Running,	83, 87	
Sailor's,	85, 131	
Spanish,	88, 131	
Three Loop,	87, 131	
Underhand,	85	
Water,	86	
Butterfly,	84	
Clove Hitch,	77	
Crown,	94	
Double Butterfly,	85	
Double Overhand,	75	
Double Sheet Bend,	81	
Figure-of-Eight,	75	
Figure-of-Eight Loop,	84	
Figure-of-Eight on a Bight,	127	
Fireman's,	89, 110, 127	
Flemish Bend,	92	
Girth Hitch,	78	
Granny,	79	
Half Hitch,	76	
Handcuff,	91	
Hitching Tie,	89	
Lariat,	83	
Larkshead,	78	
Larkshead on a Toggle,	89	
Loop Knot,	84	
Lubber's,	79	
Man Harness,	84	
Man Overboard,	89, 110, 127	
Man Sling,	90	
Marline Spike Hitch,	90, 112	
Marling,	74	
Middleman's,	84	
Overhand,	75	
Overhand Loop Knot,	84	
Pipe Hitch,	78	
Prusik,	91, 112	

I N D E X

Knots (Continued)	
Reef,	79
Ring Bend,	92
Round Turn,	74
Round Turn and Two Half Hitches, ..	82
Running Bowline,	83, 87
Sailor's Bowline,	85, 131
Scaffold Hitch,	139, 141
Secure,	72
Secured Clove Hitch,	77
Secured Square,	90
Sheepshank,	82, 90
Sheepshank Secured,	82
Sheet Bend,	81
Shoestring Tie,	80
Simple Hitch,	74
Slip,	83
Slippery,	72
Slippery Half Hitch,	76
Slippery Reef,	79
Slippery Sheet Bend,	81
Spanish Bowline,	88, 131
Square,	79
Stevedore,	76
Surgeon's,	80
Tautline Hitch,	78
Thief,	79
Timber Hitch,	77
Tomfool,	91
Tool Sling,	92
Two Bowlines,	80
Two Half Hitches,	77
Underhand,	75
Water,	92
Weaver's,	81
Knots, Classification of,	73
Kong Ascenders,	115
Ladders (See Rope Climbing)	
Land Compasses,	164
Land Raft,	281, 282
Lashings:	
Introduction to,	97
Lengths,	97
Thicknesses,	97
Types of:	
Diagonal,	98
Japanese Square,	98
Round,	99
Sailmaker's Three Pole,	101
Sailmaker's Four Pole,	101
Square Shear,	99
Traditional Shear,	99
Traditional Square,	97
Traditional Tripod,	100
Latitude, Finding,	222
Latitude Parallels,	147, 148
Ledger,	287
Left Hand Lay,	65
Lensatic Compass,	160
Levers:	
Introduction to,	54
First Class,	56
Second Class,	57
Third Class,	57
Life Basket,	132
Lift the Heavyweight,	248
Light Weight Ax,	17
Lifting and Moving Loads,	56
Line Orienteering,	170
Little Dipper,	220
Lockback Knife,	6
Log Contests:	
Aerial Torpedo,	235
Bouncing,	235
Caber Tossing,	235
Carrying,	236
Chopping,	235
Sawing,	237
Splitting,	236
Throwing,	235
Twitching,	235
Log Raft,	183-185
Log Splitting Ax,	20
Logger's Ax,	17
Logging,	26, 27
Longitude,	148
Loop Knot Ladder,	111
Lower Belay,	127
Lubber's Line,	161
Lug Hooks,	51
Lumberjack's Pulley,	108
Machete,	12
Magnetic Compass,	159, 162
Magnetic North,	153
Magnetic Poles,	172
Makeshift Tackle,	61
Making Rope:	
Rope Crank,	71
Rope Spinner,	70
Tin Can Ropemaker,	69
Man Overboard Knot,	89, 110, 127
Manila Fiber Rope,	63
Map:	
Projections,	147
References,	156
Symbols,	149
Maps,	145-158
Types of,	145, 146
Marginal Explanation of Topograph-	
ical Maps,	150
Mariner's Compass,	160, 161
Marline Spike Hitch Ladder,	90, 112
Marling,	74
Marrying,	95
Mattock,	47
Mechanical Advantage,	52-54
Metric Conversion Table,	148
Michigan Ax,	16
Middle Weight Ax,	17
Military Commando Knife,	10
Mill File,	49
Monkey Bridge,	143
Mooring,	4
Moon,	221, 222
Morse and Telephone Systems,	232
Morse Code,	229
Mousetrap,	225, 226
Mousing,	106, 287

I N D E X

Nail Mark,	4	Problems (See Hypothetical Problems)	
Nest of Saws,	41	Pruning Knife,	9
New England Ax,	16	Prusik Knot,	91, 112
Nomenclature:		Prusiking,	112, 113
Ax,	16	Pulley Arrangement for Crossing 138, 139	
Block,	53	Pulleys,	46, 52, 53, 54
Bolt Cutter,	48	Pulp Blade of Saw,	35
Booby Trap,	224	Push Dagger,	12
Boom Derrick,	62		
Brace and Bits,	48	Quadripod,	287
Cant Hook,	50	Quillion,	11
Eye Hook,	106		
File,	49	Raft Using Pendulous Action,	187
Jack Knife,	9	Rafts:	
Rope Spinner,	70	Australian Two Poncho Raft,	182
Sheath Knife,	11	Barrel Raft,	178
North Temperate Zone, ... 147, 211, 219		Brush Boat Raft,	179
Nylon Rope,	64	Brush Raft,	180
		Bull Boat,	179
Oil Drum Raft,	178	Catamaran,	182
Oilstones,	13, 14	Constructing a Log Raft,	185
One Rope Bridge,	132, 135	Coracle,	181
Orientation,	287	Flying Ferry,	188
Orienteering:		Ice Raft,	182
Line,	170	Inner Tube Raft,	178
Point,	169	Log Rafts,	183-187
Project,	169	Oil Drum Raft,	178
Route,	169	Pendulous Action,	187
Score,	169	Pneumatic,	177
Orienting a Compass,	164	Pressure Bars,	183
Orion Constellation,	220, 221	Sausage Raft,	181
		(See Also Floatation Devices)	
Pace (See Also Stride)	206	Rafting General,	173
Pacing,	166, 287	Rafting Safety Rules,	188
Pack Saw,	40	Rake of Saw,	35
Parbuckles,	57	Raker Teeth of Knife,	12
Peavey,	46, 50, 238	Raker Teeth on Saw Blade,	39
Pen Knife,	6	Rappel Seats,	120, 121
Pick Mattock,	46, 47	Rappel Walls,	122-124
Picket Holdfast,	103	Rappelling (Abseiling):	
Pioneering,	45	Introduction,	116
Piton Hammer,	114	Methods:	
Pitons,	114	Body,	118
Plant Fiber Rope,	63	Hasty,	117
Pneumatic Canvas Raft,	177	Seat-Hip,	120
Pocket Knife Origin,	1	Seat-Shoulder,	118
Pocket Knives:		Rate of Speed of a Stream,	188
Basic Blade Points,	5	Realistic First Aid,	245
History of,	1	Reeving a Block,	53
Making,	3	Rescue Ties,	130
Nomenclature,	9	Revolving Derrick Bridge,	251
Sharpening,	13	Rewedging Ax Handles,	23
Types of,	5-7	Ricasso,	11
Pointer Stars,	220	Rigging a Raft Sail,	186
Polaris,	220	Rockaway Ax,	16
Political - Physical Maps,	146	Rockwell Hardness,	5
Political Township,	151	Rope:	
Poll Ax,	17	Breaking Strength,	65
Post Hole Auger,	46, 48	Cable-laid,	65
Polyester Rope,	64	Care of,	66
Polypropylene Rope,	64	Coiling,	66, 67
Pommel,	11	Hawser,	65
"Pop Out" Snake,	225	Lay of,	65
Pressure Bars,	183, 184	Making,	69-71
Prime Meridian,	147, 148	Safe Working Load,	65

I N D E X

Rope (Continued)	
Shroud-Laid Rope,	65
Throwing,	66, 67
Tips,	68
Types of:	
Plant Fiber Ropes:	
Asiatic Hemp,	63
Cotton,	64
Jute,	63
Manila,	63
Sisal,	63
Synthetic Ropes:	
Kevlar,	64
Nylon,	64
Polyester,	64
Polypropylene,	64
Whippings,	68
Rope Climbing:	
Ascenders,	115
Bachmann's Knot,	116
Chock,	110
Equipment,	114
Etrier,	111
Footlock,	109
Free,	109
Grappling Hook,	123
Loop Knot,	111
Man Overboard,	110
Marline Spike Hitch,	112
Overhand Knot,	111
Prusiking,	112, 113
Stick Ladder,	110
Tension Climbing,	123
Rope Crank,	71
Rope Knife,	8
Rope Making,	69-71
Rope Spinner,	70
Rope Tackle,	107
Rope Thimble,	94
Round Robin,	233
Round Turn,	74
Running Block,	53
Running Loops,	73
Running Speeds,	167
Safe Working Load of Rope,	65
Sail for Raft,	186
Sailmaker's Whipping,	68
Sausage Raft,	181
Sawbuck,	38, 42
Sawhorse,	38, 42
Saws:	
Blades,	39
Care of,	43
History of,	35
Kerf,	35
Nesting,	41
Nomenclature,	35
Parts of,	36
Rake,	35
Set,	35
Sharpening,	44
Survival,	40
Teeth,	35

Saws (Continued)	
Types of:	
Bow,	39
Buck,	37, 38
Cable,	41
Nested,	41
Pack,	40
Safety,	40
Survival,	40
Timber Crosscut,	36-37
Utilizing the Saw,	41
Scaffold Hitch,	139, 141
Scuba Diving Knife,	12
Seaman's Whipping,	68
Seat Harnesses,	119, 120, 121
Secret Messages,	228
Seizings,	102
Self-Lifting Hoist,	60, 238, 248
Sharpening Axes,	31
Sharpening Knives,	13
Sharpening Saws,	44
Sharpening Stones,	13, 14
Shear Lashing,	99
Shear Legs,	59, 100
Shear Movement,	134
Sheath Knives:	
Classification,	3, 10
Nomenclature of,	11
Sharpening,	13
Throwing,	234
Types of,	10
Sheave,	53
Shingling Hatchet,	22
Shroud-Laid Rope,	65
Shovels,	46, 48
Sickle and Scythe,	46
Silva Compass,	160
Simple Machines:	
Inclined Plane,	55
Lever,	55
Pulley,	55
Screw,	55
Wedge,	55
Wheel and Axle,	55
Simple Tackle,	53
Single Bit Axes:	
Connecticut,	16
Dayton,	16
Hudson Bay,	16
Jersey,	16
Michigan,	16
New England,	16
Rockaway,	16
Yankee,	16
Sisal Rope,	63
Skinning Knife,	10
Sling, Ancient Weapon,	247
Sling, Rope,	91
Sling, Wire Rope,	52
Slip Stone,	14
Smithing,	4
Snaplinks,	112, 114
Snatch Block,	53
Solar or Sun Compass,	159

I N D E X

Solstice,	211, 218, 219	Tin Can Rope Maker,	69
South American Bolas,	246	Tinder,	191
South Temperate Zone,	147, 212, 219	Tips, Rope,	68
Southern Cross,	223	Toggle Ropes,	129, 130
Spaced Overhand Knot Ladder,	111	Toggles,	72
Spanish Bowline,	88, 131	Tomahawk Throwing,	236
Spanish Windlass,	107	Tool Sling,	92
Specialty Knots,	73	Tools,	46-62
Splices:		Topographical Map Symbols,	149
Back,	94	Topographical Maps,	148, 158
Docker's Eye,	93	Torrid Zone,	147, 216, 217
End,	94	Townships, Congressional and	
Eye,	93	Political,	150, 151
Introduction to,	93	Townships and Range Numbers,	151
Long,	96	Traffic Jam,	251
Sailor's Eye,	93	Trailing Point Knife,	14
Short,	95	Tramways,	142, 288
Tucked Eye,	93	Transom,	288
Stainless Clad Steel,	1	Transverse Mercator Zone,	154, 155
Stainless Steel,	1	Traveling Safety Saw,	40
Standing Block,	53	Traversing a Rope:	
State Coordinate System,	153	American Crawl,	137, 139
Steel, Grades of,	4	Boatswain's Chair,	138, 139
Steel of a Knife Blade,	4	British Crawl,	137
Steel for Sharpening,	13	Cableway,	140, 142
Step (See Pace and Stride)		Pulley Arrangement,	138, 139
Step-Slide,	138, 139, 256	Step-Slide,	138, 139
Stick Ladder,	110	Tyrolean Traverse,	135, 137, 139
Stock Knife,	8	Tree Evacuation,	130, 131
Stream Race,	245	Trestle,	288
Stride vs. Step or Pace,	206	Trigger on Booby Trap,	224
String Burning Contest,	248	Tripod,	60
Strop for Sharpening,	13	Tripod Lashing,	100
Strop, Endless Rope,	288	Trolley,	255
Sun and Glass,	255	Tropic Zone,	147, 216, 217
Survival Knife,	10	True North,	153
Survival Type Saws,	40	Turnbuckles,	106
Suspension Traverse,	288	Twisted Rope,	64
Sweep of Knife,	9	Tyrolean Traverse,	135, 137, 139
Swedge of Knife,	11		
Synthetic Ropes,	64	Undercut,	25
		Universal Transverse Mercator	
Tang of Knife,	4	Grid System,	154-156
Telegrips,	46, 51	Universal Transverse Mercator	
Tempering,	4	Zone,	154-155
Tension Climbing,	123	Upper Belay,	128
Tension Traverse,	250	Ursa Major,	220
Thematic Maps,	146	Ursa Minor,	220
Throwing Knife,	12	Utility Knife,	6
Throwing a Knife,	234		
Throwing a Rope,	66, 67	"V" Toothed Saw Blades,	39
Tightening Arrangements:		Variation,	162, 163
Block and Tackle,	106	Vernal Equinox,	218, 219
Double Butterfly-Prusik,	108		
Harvester's Hitch,	107	Walking and Running Speeds,	167
Hayman's Hitch,	107	Washita Sharpening Stones,	13
Lumberjack's Pulley,	108	Water Displacement with Air,	178
Spanish Windlass,	107	Water Displacement with Water,	184
Turnbuckles,	106	Weakening Effects of Knots,	65
Winch Hoist,	105	Wedges for Log Splitting,	28
Timber Carriers,	46, 51	Weight of Water,	178
Timber Saws,	36, 37	West Country Whipping,	68
Time of Day:		Westerly Declination,	162, 163
Estimating by Compass,	171	Whetstones,	13
Estimating by Degrees,	223	Whifflepoof,	281
Estimating by Shadow Clock,	214	Whipping a Rope,	68

DR. R. W. OELSLAGER
804 10TH AVE. S.E.
ROCHESTER, MINNESOTA 55904

I N D E X

Whipping Methods,	68
Winch-Hoists,52, 105, 106	
Windlass,	61
Windlass, Spanish,	107
Wood Chopping Mauls,	19
Wooden Mallet, 46, 48	
Woodland Camping Ax,	17
Yachtsman's Knife,	8
Yankee Ax,	16
Zenith,	210
Zones of the Earth,	147